

The Complete Maury Catalog

THIS CATALOG CONTAINS MAURY'S
Interconnect Solutions
Precision Calibration Solutions
Test & Measurement Instrument Amplifiers
Device Characterization Solutions



Shop online for
in-stock products



Maury Microwave

Your Calibration, Measurement & Modeling Solutions Partner!



*Maury Microwave
is ISO: 9001:2015/
AS9100D Certified.*

| | | |
|-------------------------------|---|----|
| Contents — General | Our Mission & Values | 15 |
| | About Maury Microwave | 16 |
| | Maury's Strategic Alliances | 18 |
| | Maury Microwave Corporation AS9100D & ISO 9001:2015 Documentation | 21 |
| | Calibration, Maintenance and Repair | 22 |

| | | |
|--|--|----|
| Contents — Interconnect Solutions | Test Essentials™ Lab Adapters & ColorConnect™ Precision Adapters | 28 |
| | Calibration-Grade (Metrology) Adapters | 31 |
| | NMD1.85mm/ 2.4mm/2.92mm/ 3.5mm Test Port Adapters | 32 |
| | 1.85mm Adapters | 34 |
| | 2.4mm Adapters | 36 |
| | 2.92mm Adapters | 38 |
| | 3.5mm Adapters | 40 |
| | 3.5mm (QT3.5mm™) Quick Test Adapters | 42 |
| | 7mm Adapters | 43 |
| | Type N Adapters | 44 |
| | TNC Adapters | 46 |
| | BNC & SMA Adapters | 47 |
| | Waveguide-To-Coaxial Adapters — Right Angle Launch | 48 |
| | Waveguide-To-Coaxial Adapters — End Launch | 49 |
| | Space Qualified Adapters | 50 |
| | Test Port Cable Assemblies | 51 |
| | StabilityPlus™ Microwave/RF Cable Assemblies | 58 |
| | StabilityPlus™ Low-Profile Microwave/RF Cable Assemblies | 68 |
| | StabilityBench™ Microwave/RF Cable Assemblies | 78 |
| | StabilityTVAC™ Cable Assemblies | 81 |
| | ColorConnect™ Precision Attenuators | 88 |
| | Torque Wrenches | 90 |
| | Connector Gages and Connector Gage Kits | 92 |

| | | |
|---|--|-----|
| Contents — Precision Calibration Solutions | Insight VNA Calibration and Measurement Software | 96 |
| | Maury Precision VNA Calibration Kits | 104 |
| | Network Analyzer Calibration Methodologies | 105 |
| | 1.85mm VNA Calibration Kits | 106 |
| | 2.4mm VNA Calibration Kits | 107 |
| | 2.92mm VNA Calibration Kits | 108 |
| | 3.5mm VNA Calibration Kits | 109 |
| | 7mm VNA Calibration Kits | 110 |
| | Type N VNA Calibration Kits | 111 |
| | 75Ω Type N VNA Calibration Kits | 112 |
| TNC VNA Calibration Kits | 113 | |

| | |
|--|-----|
| AFTNC VNA Calibration Kits | 114 |
| BNC VNA Calibration Kits | 115 |
| Waveguide VNA Calibration Kits | 116 |
| Verification Kits | 118 |
| Precision Fixed Terminations | 121 |
| Fixed Flush and Fixed Offset Shorts | 124 |
| Waveguide Fixed Flush Shorts | 125 |
| Waveguide Fixed Offset Shorts | 126 |
| Opens | 127 |
| Precision Air Lines | 128 |
| Waveguide Precision Straight Section (Shim) | 129 |
| Waveguide Straight Sections | 130 |
| Precision Mismatches | 131 |
| Mismatch Airlines | 132 |
| Waveguide Flange Information | 133 |
| Coaxial Stub Tuners | 134 |
| Noise Calibration Systems and Components | 135 |
| Cryogenic Noise Terminations (Cold Loads) | 137 |
| MT7118J99 7mm Coaxial Cryogenic Terminations | 138 |
| Waveguide Cryogenic Terminations | 139 |
| Cryogenic Termination Accessories | 140 |
| Thermal Noise Terminations (Hot Loads) | 141 |
| Coaxial Thermal Termination | 142 |
| Waveguide Thermal Terminations | 143 |
| Thermal Terminations – Options and Accessories | 144 |
| Noise Calibration Swept Data Module | 145 |

**Contents — Test
& Measurement
Instrument
Amplifiers**

| | |
|-----------------------------------|-----|
| Amplifier Frequency Map | 149 |
| Maximizing Up-Time | 175 |
| Semi-Custom and Custom Amplifiers | 175 |
| Specifications Definitions | 176 |

**Contents —
Measurement &
Modeling Device
Characterization
Solutions**

| | |
|--|-----|
| IVCAD Advanced Measurement & Modeling Software | 180 |
| Vertigo MT920-Series MMW-STUDIO | 200 |
| Supported instrumentation | 211 |
| ATSV5 Automated Tuner System Software | 212 |
| Automated Mobile Testing System Software (AMTS) | 215 |
| Automated Tuners | 217 |
| LXI™ Tuners Frequency Graph | 222 |
| High-Gamma™ & High-Power LXI™-Certified Automated Tuners | 223 |
| 7mm LXI™-Certified Automated Tuners | 224 |
| 3.5mm LXI™-Certified Automated Tuners | 225 |

| | |
|--|-----|
| 2.4mm & 1.85mm LXI™-Certified Automated Tuners | 226 |
| Millimeter-Wave LXI™-Certified Automated Tuners | 227 |
| 3.5mm & 7mm LXI™-Certified Multi-Harmonic Automated Tuners | 228 |
| Wide Matching Range Slide Screw Tuners | 230 |
| Low-Loss Probe Mounts | 232 |
| Noise Receiver and Noise Switch Modules | 234 |
| Low-Loss Couplers | 238 |
| Low-Loss Couplers with Integrated Downconverters | 240 |
| High-Power Low-Loss Pulsed Bias Tees | 241 |
| Low-Loss Coaxial Multiplexers | 244 |
| MT964 Load Pull Test Fixtures | 246 |
| Anteverta High-Precision Current Probes | 248 |
| MT1000 and MT2000 – Mixed-Signal Active Load Pull System (1.0 MHz to 40.0 GHz) And MT2001 System Software | 250 |
| Pulsed IV Systems — AM3200 Serie 3 | 265 |
| Pulsed IV Systems — AM3100 Serie 3 | 269 |
| RF Device Characterization System Integration | 274 |
| Measurement and Modeling Device Characterization Services | 276 |

Interconnect Solutions Model Index

| | | | | | | | |
|---|----|---|----|---|----|---|----|
| | | 7809F4 | 33 | 7909D3 | 33 | 7927B1 | 37 |
| | | NMD1.85mm female to 2.92mm male test port adapter | | NMD2.4mm female test port adapter | | 2.4mm female to 3.5mm male adapter | |
| 232A2 | 46 | 7821A | 35 | 7909D4 | 33 | 7927C1 | 37 |
| TNC female to TNC female adapter | | 1.85mm female to 1.85mm female adapter | | NMD2.4mm female test port adapter | | 2.4mm male to 3.5mm female adapter | |
| 232A11 | 46 | 7821B | 35 | 7909F3 | 33 | 7927D1 | 37 |
| TNC female to TNC female adapter | | 1.85mm male to 1.85mm male adapter | | NMD2.4mm female test port adapter | | 2.4mm male to 3.5mm male adapter | |
| 232B2 | 46 | 7821C | 35 | 7909F4 | 33 | 8006E1 | 42 |
| TNC male to TNC male adapter | | 1.85mm female to 1.85mm male adapter | | NMD2.4mm female test port adapter | | QT3.5mm™ male no nut to 3.5mm female adapter | |
| 232B11 | 46 | 7824A1 | 35 | 7909H1 | 33 | 8006E11 | 42 |
| TNC male to TNC male adapter | | 1.85mm female to 2.4mm female adapter | | NMD2.4mm female test port adapter | | QT3.5mm™ male 3/8-in. nut to 3.5mm female adapter | |
| 232C2 | 46 | 7824B1 | 35 | 7909J1 | 33 | 8006E21 | 42 |
| TNC female to TNC male adapter | | 1.85mm female to 2.4mm female adapter | | NMD2.4mm female test port adapter | | QT3.5mm™ male 9/16-in. nut to 3.5mm female adapter | |
| 232C11 | 46 | 7824C1 | 35 | 7909K1 | 33 | 8006Q1 | 42 |
| TNC female to TNC male adapter | | 1.85mm male to 2.4mm male adapter | | NMD2.4mm female test port adapter | | QT3.5mm™ male (guide sleeve) to 3.5mm male adapter | |
| 2606C | 43 | 7824D1 | 35 | 7921A1 | 37 | 8719A1 | 32 |
| 7mm to Type N female adapter | | 1.85mm male to 2.4mm male adapter | | 2.4mm female to 2.4mm female adapter | | NMD2.92mm female to 2.92mm (K) female test port adapter | |
| 2606D | 43 | 7826A1 | 35 | 7921B1 | 37 | 8719B1 | 32 |
| 7mm to Type N male adapter | | 1.85mm female to 2.92mm female adapter | | 2.4mm male to 2.4mm male adapter | | NMD2.92mm female to 2.92mm (K) male test port | |
| 2622A1 | 43 | 7826B1 | 35 | 7921C1 | 37 | 8009A1 | 33 |
| 7mm to TNC female adapter | | 1.85mm female to 2.92mm male adapter | | 2.4mm female to 2.4mm male adapter | | NMD3.5mm female to 3.5mm female test port adapter | |
| 2622B | 43 | 7826C1 | 35 | 7921D1 | 37 | 8009B1 | 33 |
| 7mm to TNC male adapter | | 1.85mm male to 2.92mm female adapter | | 2.4mm female to 2.4mm female adapter | | NMD3.5mm female to 3.5mm male test port adapter | |
| 2625A | 43 | 7826D1 | 35 | 7922A1 | 37 | 8009F1 | 33 |
| 7mm to SMA female adapter | | 1.85mm female to 3.5mm female adapter | | 2.4mm female to 7mm adapter | | NMD3.5mm female to NMD3.5mm male test port adapter | |
| 2625B | 43 | 7827A1 | 35 | 7922B1 | 37 | 8021A3 | 41 |
| 7mm to SMA male adapter | | 1.85mm male to 2.92mm female adapter | | 2.4mm male to 7mm adapter | | 3.5mm female to female adapter | |
| 2633C1 | 33 | 7827B1 | 35 | 7923A | 37 | 8021B3 | 41 |
| NMD3.5mm female to 7mm test port adapter | | 1.85mm female to 3.5mm male adapter | | 2.4mm female to type N female adapter | | 3.5mm male to male adapter | |
| 2698C2 | 91 | 7827C1 | 35 | 7923B | 37 | 8021C3 | 41 |
| 3/4-inch hex torque wrench (12 in. lbs) | | 1.85mm male to 3.5mm female adapter | | 2.4mm female to type N male adapter | | 3.5mm female to male adapter | |
| 2698G1 | 91 | 7827D1 | 35 | 7923C | 37 | 8021D2 | 41 |
| 9/16-inch hex torque wrench (12 in. lbs) | | 1.85mm male to 3.5mm male adapter | | 2.4mm male to type N female adapter | | 3.5mm female to female adapter | |
| 2698K1 | 91 | 7909A3 | 33 | 7923D | 37 | 8021E2 | 41 |
| 1-1/16-inch hex torque wrench (20 in. lbs) | | NMD2.4mm female test port adapter | | 2.4mm male to type N male adapter | | 3.5mm female to female adapter | |
| 7809A1 | 33 | 7909A4 | 33 | 7926A1 | 37 | 8022S1 | 41 |
| NMD1.85mm female to 1.85mm female test port adapter | | NMD2.4mm female test port adapter | | 2.4mm female to 2.92mm (K) female adapter | | 3.5mm female to 7mm adapter | |
| 7809A2 | 33 | 7909B3 | 33 | 7926B1 | 37 | 8022T1 | 41 |
| NMD1.85mm female to 1.85mm male test port adapter | | NMD2.4mm female test port adapter | | 2.4mm female to 2.92mm (K) male adapter | | 3.5mm male to 7mm adapter | |
| 7809B3 | 33 | 7909B4 | 33 | 7926C1 | 37 | 8023A | 41 |
| NMD1.85mm female to 3.5mm female test port adapter | | NMD2.4mm female test port adapter | | 2.4mm male to 2.92mm (K) female adapter | | 3.5mm female to type N female adapter | |
| 7809B4 | 33 | 7909C1 | 33 | 7926D1 | 37 | 8023B1 | 41 |
| NMD1.85mm female to 3.5mm male test port adapter | | NMD2.4mm female test port adapter | | 2.4mm male to 2.92mm (K) male adapter | | 3.5mm female to type N male adapter | |
| 7809F3 | 33 | | | 7927A1 | 37 | 8023C | 41 |
| NMD1.85mm female to 2.92mm female test port adapter | | | | 2.4mm female to 3.5mm female adapter | | 3.5mm male to type N female adapter | |

| | | | | | | | |
|--|----|--|----|---|----|--|----|
| 8023D1 | 41 | 8723C | 39 | A020G | 93 | AT-24-01-20 | 88 |
| 3.5mm male to type N male adapter | | 2.92mm male to type N female adapter | | Type N 75 Ω connector gage kit (push-on) | | 20 dB 2.4mm Fixed Attenuator | |
| 8025A1 | 41 | 8723D | 39 | A020K | 92 | AT-292-01-01 | 88 |
| 3.5mm female to TNC female adapter | | 2.92mm male to type N male adapter | | Type N digital connector gage kit (thread-on) | | 1 dB 2.92mm Fixed Attenuator | |
| 8025B1 | 41 | 8725A1 | 39 | A027P1 | 93 | AT-292-01-03 | 88 |
| 3.5mm female to TNC male adapter | | 2.92mm female to 7mm adapter | | SMA connector gage kit (push-on) | | 3 dB 2.92mm Fixed Attenuator | |
| 8025C1 | 41 | 8725B1 | 39 | A027A1 | 93 | AT-292-01-06 | 88 |
| 3.5mm male to TNC female adapter | | 2.92mm male to 7mm adapter | | SMA connector gage kit (push-on) | | 6 dB 2.92mm Fixed Attenuator | |
| 8025D1 | 41 | 8799A1 | 91 | A027G1 | 93 | AT-292-01-10 | 88 |
| 3.5mm male to TNC male adapter | | 0.312 hex torque wrench | | SMA connector gage kit (push-on) | | 10 dB 2.92mm Fixed Attenuator | |
| 8028A1 | 41 | 8799D1 | 91 | A027M1 | 93 | AT-292-01-20 | 88 |
| 3.5mm female to BNC female adapter | | 0.312 hex torque wrench | | SMA connector gage kit (push-on) | | 20 dB 2.92mm Fixed Attenuator | |
| 8028B1 | 41 | 8817A | 45 | A028D | 93 | AT-SMA-02-01 | 88 |
| 3.5mm female to BNC male adapter | | Type N female to TNC adapter | | 7mm connector gage kit (thread-on) | | 1 dB SMA Fixed Attenuator | |
| 8028C1 | 41 | 8817B | 45 | A028F | 93 | AT-SMA-02-03 | 88 |
| 3.5mm male to BNC female adapter | | Type N female to TNC male adapter | | 7mm connector gage kit (thread-on) | | 3 dB SMA Fixed Attenuator | |
| 8028D1 | 41 | 8817C | 45 | A034B1 | 93 | AT-SMA-02-06 | 88 |
| 3.5mm male to BNC male adapter | | Type N male to TNC female adapter | | 2.92mm (K)/3.5mm connector gage kit (push-on) | | 6 dB SMA Fixed Attenuator | |
| 8582D3 | 47 | 8817D | 45 | A034E | 93 | AT-SMA-02-10 | 88 |
| BNC female 75 Ω to 7mm adapter | | Type N male to TNC male adapter | | 2.92mm (K)/3.5mm connector gage kit (thread-on) | | 10 dB SMA Fixed Attenuator | |
| 8582D4 | 47 | 8821A1 | 45 | A035E | 93 | AT-SMA-02-20 | 88 |
| BNC female 75 Ω fixed termination | | Type N female to BNC female adapter | | 2.4mm connector gage kit (thread-on) | | 20 dB SMA Fixed Attenuator | |
| 8682A1 | 41 | 8821B1 | 45 | A042A | 93 | CC-A-24-FF | 30 |
| 3.5mm female to AFTNC female adapters | | Type N female to BNC male adapter | | SMP/GPO™ connector gage kit (push-on) | | 2.4mm female to 2.4mm female adapter | |
| 8682B1 | 41 | 8821C1 | 45 | A048A | 92 | CC-A-24-MF | 30 |
| 3.5mm female to AFTNC male adapters | | Type N male to 50 BNC female adapter | | 1.85mm/2.4mm digital conn gage kit | | 2.4mm male to 2.4mm female adapter | |
| 8682C1 | 41 | 8821D1 | 45 | A050A | 92 | CC-A-24-MM | 30 |
| 3.5mm male to AFTNC female adapters | | Type N male to 50 BNC male adapter | | 2.92mm /3.5mm digital conn gage kit | | 2.4mm male to 2.4mm male adapter | |
| 8682D1 | 41 | 8828A2 | 45 | AT-185-01-01 | 88 | CC-A-35-FF | 30 |
| 3.5mm male to AFTNC male adapters | | Type N female to type N female adapter | | 1 dB 1.85mm Fixed Attenuator | | 3.5mm female to 3.5mm female adapter | |
| 8714A2 | 39 | 8828B2 | 45 | AT-185-01-03 | 88 | CC-A-35-MM | 30 |
| 2.92mm (K) female to 2.92mm (K) female adapter | | Type N male to type N male adapter | | 3 dB 1.85mm Fixed Attenuator | | 3.5mm male to 3.5mm male adapter | |
| 8714B2 | 39 | 8829A1 | 33 | AT-185-01-06 | 88 | CC-A-35N-FF | 30 |
| 2.92mm (K) male to 2.92mm (K) male adapter | | NMD3.5mm female to type N female adapter | | 6 dB 1.85mm Fixed Attenuator | | 3.5mm female to type N female adapter | |
| 8714C2 | 39 | 8829B1 | 33 | AT-185-01-10 | 88 | CC-A-35N-FM | 30 |
| 2.92mm (K) female to 2.92mm (K) male adapter | | NMD3.5mm female to type N male adapter | | 10 dB 1.85mm Fixed Attenuator | | 3.5mm female to type N male adapter | |
| 8714D1 | 39 | A007A | 93 | AT-185-01-20 | 88 | CC-A-35N-MF | 30 |
| 2.92mm (K) female to female adapter | | Type N connector gage kit (push-on) | | 20 dB 1.85mm Fixed Attenuator | | 3.5mm male to type N female adapter | |
| 8714E1 | 39 | A012A | 93 | AT-24-01-01 | 88 | CC-A-35N-MM | 30 |
| 2.92mm (K) female to female adapter | | BNC/TNC connector gage kit (push-on) | | 3 dB 2.4mm Fixed Attenuator | | 3.5mm male to type N male adapter | |
| 8723A | 39 | A020A | 93 | AT-24-01-03 | 88 | CC-A-185-FF | 30 |
| 2.92mm female to type N female adapter | | Type N connector gage kit (push-on) | | 3 dB 2.4mm Fixed Attenuator | | 1.85mm female to 1.85mm female adapter | |
| 8723B | 39 | A020D | 93 | AT-24-01-06 | 88 | CC-A-185-MF | 30 |
| 2.92mm female to type N male adapter | | Type N connector gage kit (thread-on) | | 6 dB 2.4mm Fixed Attenuator | | 1.85mm male to 1.85mm female adapter | |
| | | | | AT-24-01-10 | 88 | | |
| | | | | 10 dB 2.4mm Fixed Attenuator | | | |

| | | | | | | | |
|--|----|---|----|---|----|---|----|
| CC-A-185-MM | 30 | J236A3 | 48 | M221A8 | 49 | Q200A3 | 48 |
| 1.85mm male to 1.85mm male adapter | | Waveguide-to-coaxial adapter — right angle launch | | Waveguide-to-coaxial adapter — end launch | | Waveguide-to-coaxial adapter — right angle launch | |
| CC-A-292-FF | 30 | J236B3 | 48 | M221B8 | 49 | Q200B3 | 48 |
| 2.92mm female to 2.92mm female adapter | | Waveguide-to-coaxial adapter — right angle launch | | Waveguide-to-coaxial adapter — end launch | | Waveguide-to-coaxial adapter — right angle launch | |
| CC-A-292-MF | 30 | J237A6 | 49 | M229A8 | 49 | Q236A1 | 48 |
| 2.92mm male to 2.92mm female adapter | | Waveguide-to-coaxial adapter — end launch | | Waveguide-to-coaxial adapter — end launch | | Waveguide-to-coaxial adapter — right angle launch | |
| CC-A-292-MM | 30 | J237B6 | 49 | M230A1 | 49 | Q236B1 | 48 |
| 2.92mm male to 2.92mm male adapter | | Waveguide-to-coaxial adapter — end launch | | Waveguide-to-coaxial adapter — end launch | | Waveguide-to-coaxial adapter — right angle launch | |
| CC-A-2435-FF | 30 | K200A1 | 48 | M230B1 | 49 | Q237A8 | 49 |
| 2.4mm female to 3.5mm female adapter | | Waveguide-to-coaxial adapter — right angle launch | | Waveguide-to-coaxial adapter — end launch | | Waveguide-to-coaxial adapter — end launch | |
| CC-A-2435-FM | 30 | K200B1 | 48 | N200A8 | 48 | Q237B8 | 49 |
| 2.4mm female to 3.5mm male adapter | | Waveguide-to-coaxial adapter — right angle launch | | Waveguide-to-coaxial adapter — right angle launch | | Waveguide-to-coaxial adapter — end launch | |
| CC-A-2435-MF | 30 | K230A6 | 49 | N200B8 | 48 | SB-N-MM-24 | 78 |
| 2.4mm male to 3.5mm female adapter | | Waveguide-to-coaxial adapter — end launch | | Waveguide-to-coaxial adapter — right angle launch | | 24-in. Type N StabilityBench™ RF/Microwave Cable Assy | |
| CC-A-2435-MM | 30 | K230B6 | 49 | N230A3 | 49 | SB-N-MM-36 | 78 |
| 2.4mm male to 3.5mm male adapter | | Waveguide-to-coaxial adapter — end launch | | Waveguide-to-coaxial adapter — end launch | | 36-in. Type N StabilityBench™ RF/Microwave Cable Assy | |
| CC-A-24292-FF | 30 | K233A8 | 49 | N230B3 | 49 | SB-N-MM-48 | 78 |
| 2.4mm female to 2.92mm female adapter | | Waveguide-to-coaxial adapter — end launch | | Waveguide-to-coaxial adapter — end launch | | 48-in. Type N StabilityBench™ RF/Microwave Cable Assy | |
| CC-A-24292-FM | 30 | K233B8 | 49 | P200A8 | 48 | SB-N-MM-60 | 78 |
| 2.4mm female to 2.92mm male adapter | | Waveguide-to-coaxial adapter — end launch | | Waveguide-to-coaxial adapter — right angle launch | | 60-in. Type N StabilityBench™ RF/Microwave Cable Assy | |
| CC-A-24292-MF | 30 | K236A1 | 48 | P200B8 | 48 | SB-N-MM-78 | 78 |
| 2.4mm male to 2.92mm female adapter | | Waveguide-to-coaxial adapter — right angle launch | | Waveguide-to-coaxial adapter — right angle launch | | 78-in. Type N StabilityBench™ RF/Microwave Cable Assy | |
| CC-A-24292-MM | 30 | K236B1 | 48 | P209D8 | 48 | SB-SMA-MM-24 | 78 |
| 2.4mm male to 2.92mm male adapter | | Waveguide-to-coaxial adapter — right angle launch | | Waveguide-to-coaxial adapter — right angle launch | | 24-in. SMA StabilityBench™ RF/Microwave Cable Assy | |
| CC-A-N-FF | 30 | K237A8 | 49 | P213D8 | 48 | SB-SMA-MM-36 | 78 |
| Type N female to type N female adapter | | Waveguide-to-coaxial adapter — end launch | | Waveguide-to-coaxial adapter — right angle launch | | 36-in. SMA StabilityBench™ RF/Microwave Cable Assy | |
| CC-A-N-MF | 30 | K237B8 | 49 | P214D8 | 48 | SB-SMA-MM-48 | 78 |
| Type N male to type N female adapter | | Waveguide-to-coaxial adapter — end launch | | Waveguide-to-coaxial adapter — right angle launch | | 48-in. SMA StabilityBench™ RF/Microwave Cable Assy | |
| CC-A-N-MM | 30 | M200A8 | 48 | P221A8 | 49 | SB-SMA-MM-60 | 78 |
| Type N male to type N male adapter | | Waveguide-to-coaxial adapter — right angle launch | | Waveguide-to-coaxial adapter — end launch | | 60-in. SMA StabilityBench™ RF/Microwave Cable Assy | |
| CC-A-SMA-FF | 30 | M200B8 | 48 | P221B8 | 49 | SB-SMA-MM-78 | 78 |
| SMA female to SMA female adapter | | Waveguide-to-coaxial adapter — right angle launch | | Waveguide-to-coaxial adapter — end launch | | 78-in. SMA StabilityBench™ RF/Microwave Cable Assy | |
| CC-A-SMA-MF | 30 | M209D8 | 48 | P229A8 | 49 | SP-185-MM-24 | 58 |
| SMA male to SMA female adapter | | Waveguide-to-coaxial adapter — right angle launch | | Waveguide-to-coaxial adapter — end launch | | 24-in. 1.85 Stability™ RF/Microwave Cable Assy | |
| CC-A-SMA-MM | 30 | M213D8 | 48 | P230A8 | 49 | SP-185-MM-36 | 58 |
| SMA male to SMA male adapter | | Waveguide-to-coaxial adapter — right angle launch | | Waveguide-to-coaxial adapter — end launch | | 36-in. 1.85 Stability™ RF/Microwave Cable Assy | |
| CC-A-SMAN-FF | 30 | M214D8 | 48 | P230B8 | 49 | SP-185-MM-48 | 58 |
| SMA female to type N female adapter | | Waveguide-to-coaxial adapter — right angle launch | | Waveguide-to-coaxial adapter — end launch | | 48-in. 1.85 Stability™ RF/Microwave Cable Assy | |
| CC-A-SMAN-MF | 30 | | | | | | |
| SMA male to type N female adapter | | | | | | | |
| CC-A-SMAN-MM | 30 | | | | | | |
| SMA male to type N male adapter | | | | | | | |
| CC-A-SMAN-FM | 30 | | | | | | |
| SMA female to type N male adapter | | | | | | | |

| | | | | | | | |
|--|----|---|----|--|----|---|----|
| SP-24-MM-24 | 58 | SP-TNCA-MM-36 | 58 | SV-292-FM-38 | 51 | TE-A-35-FF | 30 |
| 24-in. 2.4mm StabilityPlus™ RF/ Microwave Cable Assy | | 36-in. TNCA StabilityPlus™ RF/ Microwave Cable Assy | | 38-in. 2.92mm StabilityVNA™ RF/ Microwave Cable Assy | | 3.5mm female to 3.5mm female adapter | |
| SP-24-MM-36 | 58 | SP-TNCA-MM-48 | 58 | SV-292-FF-38 | 51 | TE-A-35-MF | 30 |
| 36-in. 2.4mm StabilityPlus™ RF/ Microwave Cable Assy | | 48-in. TNCA StabilityPlus™ RF/ Microwave Cable Assy | | 38-in. 2.92mm StabilityVNA™ RF/ Microwave Cable Assy | | 3.5mm male to 3.5mm female adapter | |
| SP-24-MM-48 | 58 | SP-TNCA-MM-60 | 58 | SV-292-FM-48 | 51 | TE-A-35-MM | 30 |
| 48-in. 2.4mm StabilityPlus™ RF/ Microwave Cable Assy | | 60-in. TNCA StabilityPlus™ RF/ Microwave Cable Assy | | 48-in. 2.92mm StabilityVNA™ RF/ Microwave Cable Assy | | 3.5mm male to 3.5mm male adapter | |
| SP-35-MM-24 | 58 | SP-TNCA-MM-78 | 58 | SV-292-FF-48 | 51 | TE-A-35N-FF | 30 |
| 24-in. 3.5mm Stability™ RF/ Microwave Cable Assy | | 78-in. TNCA StabilityPlus™ RF/ Microwave Cable Assy | | 48-in. 2.92mm StabilityVNA™ RF/ Microwave Cable Assy | | 3.5mm female to type N female adapter | |
| SP-35-MM-36 | 58 | SP-(*)-MM-XX-LP | 75 | SV-24292-FM-25 | 51 | TE-A-35N-FM | 30 |
| 48-in. 3.5mm StabilityPlus™ RF/ Microwave Cable Assy | | Type N StabilityPlus™ Low-Profile Cable Assy | | 25-in. 2.4mm/2.92mm StabilityVNA™ RF/Microwave Cable Assy | | 3.5mm female to type N male adapter | |
| SP-35-MM-48 | 58 | SV-185-FM-25 | 51 | SV-24292-FF-25 | 51 | TE-A-35N-MF | 30 |
| 48-in. 3.5mm StabilityPlus™ RF/ Microwave Cable Assy | | 25-in. 1.85mm StabilityVNA™ RF/ Microwave Cable Assy | | 25-in. 2.4mm/2.92mm StabilityVNA™ RF/Microwave Cable Assy | | 3.5mm male to type N female adapter | |
| SP-35-MM-60 | 58 | SV-185-FF-25 | 51 | SV-24292-FM-38 | 51 | TE-A-35N-MM | 30 |
| 60-in. 3.5mm StabilityPlus™ RF/ Microwave Cable Assy | | 25-in. 1.85mm StabilityVNA™ RF/ Microwave Cable Assy | | 38-in. 2.4mm/2.92mm StabilityVNA™ RF/Microwave Cable Assy | | 3.5mm male to type N male adapter | |
| SP-35-MM-78 | 58 | SV-185-FM-38 | 51 | SV-24292-FF-38 | 51 | TE-A-185-FF | 30 |
| 78-in. 3.5mm StabilityPlus™ RF/ Microwave Cable Assy | | 38-in. 1.85mm StabilityVNA™ RF/ Microwave Cable Assy | | 38-in. 2.4mm/2.92mm StabilityVNA™ RF/Microwave Cable Assy | | 1.85mm female to 1.85mm female adapter | |
| SP-292-MM-24 | 58 | SV-185-FF-38 | 51 | SV-24292-FM-48 | 51 | TE-A-185-MF | 30 |
| 24-in. 2.92mm StabilityPlus™ RF/ Microwave Cable Assy | | 38-in. 1.85mm StabilityVNA™ RF/ Microwave Cable Assy | | 48-in. 2.4mm/2.92mm StabilityVNA™ RF/Microwave Cable Assy | | 1.85mm male to 1.85mm female adapter | |
| SP-292-MM-36 | 58 | SV-185-FM-48 | 51 | SV-24292-FF-48 | 51 | TE-A-185-MM | 30 |
| 36-in. 2.92mm StabilityPlus™ RF/ Microwave Cable Assy | | 48-in. 1.85mm StabilityVNA™ RF/ Microwave Cable Assy | | 48-in. 2.4mm/2.92mm StabilityVNA™ RF/Microwave Cable Assy | | 1.85mm male to 1.85mm male adapter | |
| SP-292-MM-48 | 58 | SV-185-FF-48 | 51 | SV-35-FM-25 | 51 | TE-A-292-FF | 30 |
| 48-in. 2.92mm StabilityPlus™ RF/ Microwave Cable Assy | | 48-in. 1.85mm StabilityVNA™ RF/ Microwave Cable Assy | | 25-in. 3.5mm StabilityVNA™ RF/ Microwave Cable Assy | | 2.92mm female to 2.92mm female adapter | |
| SP-292-MM-60 | 58 | SV-24-FM-25 | 51 | SV-35-FF-25 | 51 | TE-A-292-MF | 30 |
| 60-in. 2.92mm StabilityPlus™ RF/ Microwave Cable Assy | | 25-in. 2.4mm StabilityVNA™ RF/ Microwave Cable Assy | | 25-in. 3.5mm StabilityVNA™ RF/ Microwave Cable Assy | | 2.92mm male to 2.92mm female adapter | |
| SP-292-MM-78 | 58 | SV-24-FF-25 | 51 | SV-35-FM-38 | 51 | TE-A-292-MM | 30 |
| 78-in. 2.92mm StabilityPlus™ RF/ Microwave Cable Assy | | 25-in. 2.4mm StabilityVNA™ RF/ Microwave Cable Assy | | 38-in. 3.5mm StabilityVNA™ RF/ Microwave Cable Assy | | 2.92mm male to 2.92mm male adapter | |
| SP-N-MM-24 | 58 | SV-24-FM-38 | 51 | SV-35-FF-38 | 51 | TE-A-2435-FF | 30 |
| 24-in. Type N StabilityPlus™ RF/ Microwave Cable Assy | | 38-in. 2.4mm StabilityVNA™ RF/ Microwave Cable Assy | | 38-in. 3.5mm StabilityVNA™ RF/ Microwave Cable Assy | | 2.4mm female to 3.5mm female adapter | |
| SP-N-MM-36 | 58 | SV-24-FF-38 | 51 | SV-35-FM-48 | 51 | TE-A-2435-FM | 30 |
| 36-in. Type N StabilityPlus™ RF/ Microwave Cable Assy | | 38-in. 2.4mm StabilityVNA™ RF/ Microwave Cable Assy | | 48-in. 3.5mm StabilityVNA™ RF/ Microwave Cable Assy | | 2.4mm female to 3.5mm male adapter | |
| SP-N-MM-48 | 58 | SV-24-FM-48 | 51 | SV-35-FF-48 | 51 | TE-A-2435-MF | 30 |
| 48-in. Type N StabilityPlus™ RF/ Microwave Cable Assy | | 48-in. 2.4mm StabilityVNA™ RF/ Microwave Cable Assy | | 48-in. 3.5mm StabilityVNA™ RF/ Microwave Cable Assy | | 2.4mm male to 3.5mm female adapter | |
| SP-N-MM-60 | 58 | SV-24-FF-48 | 51 | TE-A-24-FF | 30 | TE-A-24292-FF | 30 |
| 60-in. Type N StabilityPlus™ RF/ Microwave Cable Assy | | 48-in. 2.4mm StabilityVNA™ RF/ Microwave Cable Assy | | 2.4mm female to 2.4mm female adapter | | 2.4mm female to 2.92mm female adapter | |
| SP-N-MM-78 | 58 | SV-292-FM-25 | 51 | TE-A-24-MF | 30 | TE-A-24292-FM | 30 |
| 78-in. Type N StabilityPlus™ RF/ Microwave Cable Assy | | 25-in. 2.92mm StabilityVNA™ RF/ Microwave Cable Assy | | 2.4mm male to 2.4mm female adapter | | 2.4mm female to 2.92mm male adapter | |
| SP-TNCA-MM-24 | 58 | SV-292-FF-25 | 51 | TE-A-24-MM | 30 | TE-A-24292-MF | 30 |
| 24-in. TNCA StabilityPlus™ RF/ Microwave Cable Assy | | 25-in. 2.92mm StabilityVNA™ RF/ Microwave Cable Assy | | 2.4mm male to 2.4mm male adapter | | 2.4mm male to 2.92mm female adapter | |
| | | | | | | TE-A-24292-MM | 30 |
| | | | | | | 2.4mm male to 2.92mm male adapter | |

| | | | | | | | |
|---|----|---|----|---|--|---|-----|
| TE-A-N-FF | 30 | TW-12 | 91 | Precision Calibration Solutions Model Index | 1778G | 134 | |
| Type N female to type N female adapter | | 0.750 hex torque wrench | | | Type N double-stub tuner (0.2-0.5 GHz; 30.0-inch travel) | | |
| TE-A-N-MF | 30 | U210C6 | 48 | 332E | 122 | 1819A | 134 |
| Type N male to type N female adapter | | Waveguide-to-coaxial adapter — right angle launch | | TNC female fixed termination | | SMA triple-stub tuner (0.4-1.0 GHz; 15.0-inch travel) | |
| TE-A-N-MM | 30 | U211C6 | 48 | 332F | 122 | 1819B | 134 |
| Type N male to type N male adapter | | Waveguide-to-coaxial adapter — right angle launch | | TNC male fixed termination | | SMA triple-stub tuner (0.8-4.0 GHz; 7.5-inch travel) | |
| TE-A-SMA-FF | 30 | U233A1 | 49 | 351A2 | 122 | 1819C | 134 |
| SMA female to SMA female adapter | | Waveguide-to-coaxial adapter — end launch | | BNC female precision fixed termination | | 1819D | 134 |
| TE-A-SMA-MF | 30 | U233B1 | 49 | 351B2 | 122 | SMA triple-stub tuner (2.0-12.0 GHz; 3.0-inch travel) | |
| SMA male to SMA female adapter | | Waveguide-to-coaxial adapter — end launch | | BNC male precision fixed termination | | 1819D | 134 |
| TE-A-SMA-MM | 30 | U236A6 | 48 | 360B | 124 | SMA triple-stub tuner (4.0-18.0 GHz; 1.75-inch travel) | |
| SMA male to SMA male adapter | | Waveguide-to-coaxial adapter — right angle launch | | 3.5mm/SMA male reference fixed flush short | | 1878A | 134 |
| TE-A-SMAN-FF | 30 | U236B6 | 48 | 360D | 124 | Type N triple-stub tuner (0.4-1.0 GHz; 15.0-inch travel) | |
| SMA female to type N female adapter | | Waveguide-to-coaxial adapter — right angle launch | | 3.5mm/SMA female reference fixed flush short | | 1878B | 134 |
| TE-A-SMAN-FM | 30 | U237A1 | 49 | 361N2 | 124 | Type N triple-stub tuner (0.8-4.0 GHz; 7.5-inch travel) | |
| SMA female to type N male adapter | | Waveguide-to-coaxial adapter — end launch | | BNC female general purpose fixed offset short | | 1878C | 134 |
| TE-A-SMAN-MF | 30 | U237B1 | 49 | 361P2 | 124 | Type N triple-stub tuner (2.0-18.0 GHz; 3.0-inch travel) | |
| SMA male to type N female adapter | | Waveguide-to-coaxial adapter — end launch | | BNC male general purpose fixed offset short | | 1878D | 134 |
| TE-A-SMAN-MM | 30 | X200A8 | 48 | 371N2 | 127 | Type N triple-stub tuner (4.0-18.0 GHz; 1.75-inch travel) | |
| SMA male to type N male adapter | | Waveguide-to-coaxial adapter — right angle launch | | BNC female open | | 1878G | 134 |
| TV-292 | 81 | X200B8 | 48 | 371P2 | 127 | Type N triple-stub tuner (0.2-0.5 GHz; 30.0-inch travel) | |
| 2.92mm StabilityTVAC™ Cable Assy | | Waveguide-to-coaxial adapter — right angle launch | | BNC male open | | 2503A1 | 128 |
| TV-292-LP | 81 | X209D8 | 48 | 1719A | 134 | Type N female to male bead supported air line | |
| 2.92mm StabilityTVAC™ Low-Profile Cable Assy | | Waveguide-to-coaxial adapter — right angle launch | | SMA double-stub tuner (0.4-1.0 GHz; 15.0-inch travel) | | 2503B1 | 128 |
| TV-SMA | 81 | X209D8 | 48 | 1719B | 134 | Type N female to male bead supported air line | |
| SMA StabilityTVAC™ Cable Assy | | Waveguide-to-coaxial adapter — right angle launch | | SMA double-stub tuner (0.8-4.0 GHz; 7.5-inch travel) | | 2503H | 128 |
| TV-SMA-LP | 81 | X213D8 | 81 | 1719C | 134 | Type N female to male bead supported air line | |
| SMA StabilityTVAC™ Low-Profile Cable Assy | | Waveguide-to-coaxial adapter — right angle launch | | SMA double-stub tuner (2.0-12.0 GHz; 3.0-inch travel) | | 2503H75 | 132 |
| TV-N-LL | 81 | X214D8 | 48 | 1719D | 134 | Type N mismatch air line | |
| Type N StabilityTVAC™ Low-Loss Cable Assy | | Waveguide-to-coaxial adapter — right angle launch | | SMA double-stub tuner (4.0-18.0 GHz; 1.75-inch travel) | | 2510E2 | 122 |
| TV-N-LL-LP | 81 | X221A8 | 49 | 1778A | 134 | Type N female precision fixed termination | |
| Type N StabilityTVAC™ Low-Loss Low-Profile Cable Assy | | Waveguide-to-coaxial adapter — end launch | | Type N double-stub tuner (0.4-1.0 GHz; 15.0-inch travel) | | 2510F2 | 122 |
| TV-SMA-LL | 81 | X221B8 | 49 | 1778B | 134 | Type N male precision fixed termination | |
| SMA StabilityTVAC™ Low-Loss Cable Assy | | Waveguide-to-coaxial adapter — end launch | | Type N double-stub tuner (0.8-4.0 GHz; 7.5-inch travel) | | 2553T3.12 | 128 |
| TV-SMA-LL-LP | 81 | X229A8 | 49 | 1778C | 134 | Type N female to male air line (3.12cm) | |
| SMA StabilityTVAC™ Low-Loss Low-Profile Cable Assy | | Waveguide-to-coaxial adapter — end launch | | Type N double-stub tuner (2.0-12.0 GHz; 3.0-inch travel) | | 2553T3.82 | 128 |
| TV-TNC-LL | 81 | X230A1 | 49 | 1778D | 134 | Type N female to male air line (3.82cm) | |
| TNC StabilityTVAC™ Low-Loss Cable Assy | | Waveguide-to-coaxial adapter — end launch | | Type N double-stub tuner (4.0-18.0 GHz; 1.75-inch travel) | | 2553T15 | 128 |
| TV-TNC-LL-LP | 81 | X230B1 | 49 | 1778E | 134 | Type N female to male beadless air line (15.0cm) | |
| TNC StabilityTVAC™ Low-Loss Low-Profile Cable Assy | | Waveguide-to-coaxial adapter — end launch | | Type N double-stub tuner (2.0-18.0 GHz; 3.0-inch travel) | | | |
| TW-5 | 91 | | | | | | |
| 0.312 hex torque wrench | | | | | | | |
| TW-8 | 91 | | | | | | |
| 0.312 hex torque wrench | | | | | | | |

| | | | | | | | |
|--|-----|---|-----|--|-----|---|-----|
| 2561C | 131 | 7831B1 | 122 | 7946B2 | 124 | 8043S6 | 128 |
| Type N female precision mismatch | | 1.85mm male low band fixed termination | | 2.4mm male precision fixed offset short | | 3.5mm female to male air line (6cm) | |
| 2561E | 131 | 7843S0.96 | 128 | 7946C2 | 124 | 8043S15 | 128 |
| Type N female precision mismatch | | 1.85mm female to male air line (0.96cm) | | 2.4mm female precision fixed offset short | | 3.5mm female to male air line (15cm) | |
| 2561G | 131 | 7843S1.15 | 128 | 7946D2 | 124 | 8046A6 | 124 |
| Type N female precision mismatch | | 1.85mm female to male air line (1.15cm) | | 2.4mm male precision fixed offset short | | 3.5mm female precision fixed offset short | |
| 2562C | 131 | 7843S3.00 | 128 | 7948A2 | 127 | 8047A6 | 124 |
| Type N male precision mismatch | | 1.85mm female to male air line (3.00cm) | | 2.4mm female open | | 3.5mm male precision fixed offset short | |
| 2562E | 131 | 7846A | 124 | 7948B2 | 127 | 8046F6 | 124 |
| Type N male precision mismatch | | 1.85mm female fixed offset short | | 2.4mm male open | | 3.5mm female precision fixed offset short | |
| 2562G | 131 | 7847A | 124 | 7950CK40 | 107 | 8047F6 | 124 |
| Type N male precision mismatch | | 1.85mm male fixed offset short (0.5cm) | | 2.4mm Fixed Load VNA cal kits | | 3.5mm male precision fixed offset short | |
| 2603A | 128 | 7850CK30 | 106 | 7950CK41 | 107 | 8048A6 | 127 |
| 7mm bead supported air line | | 1.85mm TRL/LRL VNA calibration kits | | 2.4mm Fixed Load VNA cal kits | | 3.5mm female open | |
| 2603B | 128 | 7850CK30 | 106 | 7950CK50 | 107 | 8048B6 | 127 |
| 7mm bead supported air line | | 1.85mm TRL/LRL VNA calibration kits | | 2.4mm Sliding Load VNA cal kits | | 3.5mm male open | |
| 2603F1 | 128 | 7931A2 | 122 | 7950CK51 | 107 | 8050CK40 | 109 |
| 7mm bead supported air line | | 2.4mm female fixed termination | | 2.4mm Sliding Load VNA cal kits | | 3.5mm fixed load VNA Cal kits | |
| 2603F75 | 132 | 7931B2 | 122 | 7950CK60 | 120 | 8050CK41 | 109 |
| 7mm mismatch air line | | 2.4mm male fixed termination | | 2.4mm Verification kits | | 3.5mm fixed load VNA Cal kits | |
| 2610F1 | 122 | 7933A1.20 | 131 | 8031A6 | 122 | 8050CK50 | 109 |
| 7mm (DC-18.0 GHz) | | 2.4mm female precision mismatch | | 3.5mm female fixed termination | | 3.5mm sliding load VNA Cal kits | |
| 2611C | 131 | 7933A1.50 | 131 | 8031B6 | 122 | 8050CK51 | 109 |
| 7mm precision mismatch | | 2.4mm female precision mismatch | | 3.5mm male fixed termination | | 3.5mm sliding load VNA Cal kits | |
| 2611E | 131 | 7933A2.00 | 131 | 8033A1.20 | 131 | 8050CK60 | 120 |
| 7mm precision mismatch | | 2.4mm female precision mismatch | | 3.5mm female precision mismatch | | 3.5mm Verification kits | |
| 2611G | 131 | 7933B1.20 | 131 | 8033A1.50 | 131 | 8550CK10 | 115 |
| 7mm precision mismatch | | 2.4mm male precision mismatch | | 3.5mm female precision mismatch | | BNC fixed load VNA Cal kits | |
| 2615D3 | 124 | 7933B1.50 | 131 | 8033A2.00 | 131 | 8580CK10 | 115 |
| 7mm precision fixed flush short | | 2.4mm male precision mismatch | | 3.5mm female precision mismatch | | BNC 75 Ω fixed load VNA Cal kits | |
| 2616D3 | 127 | 7933B2.00 | 131 | 8033B1.20 | 131 | 8583A1 | 122 |
| 7mm open | | 2.4mm male precision mismatch | | 3.5mm male precision mismatch | | BNC female 75 Ω fixed termination | |
| 2649A1 | 124 | 7942C | 128 | 8033B1.50 | 131 | 8583B1 | 122 |
| 7mm precision fixed flush short | | 2.4mm air line (4.11cm) | | 3.5mm male precision mismatch | | BNC male 75 Ω fixed termination | |
| 2650CK40 | 110 | 7942C25 | 132 | 8033B2.00 | 131 | 8584A1 | 124 |
| 7mm Fixed Load VNA Cal kits | | 2.4mm Mismatch air line (4.11cm) | | 3.5mm male precision mismatch | | BNC female 75 Ω general purpose fixed offset short | |
| 2650CK50 | 110 | 7943S1.25 | 128 | 8042C1 | 128 | 8584B1 | 124 |
| 7mm Sliding Load VNA Cal kits | | 2.4mm female to male beadless air line (1.25cm) | | 3.5mm female to male bead supported air line | | BNC male 75 Ω general purpose fixed offset short | |
| 2650CK60 | 120 | 7943S1.50 | 128 | 8042C25 | 132 | 8585A1 | 127 |
| 7mm Verification kits | | 2.4mm female to male beadless air line (1.50cm) | | 3.5mm mismatch air line | | BNC female 75 Ω open | |
| 2653L | 128 | 7943S6.25 | 128 | 8042D1 | 128 | 8585B1 | 127 |
| 7mm beadless air line (0.6cm) | | 2.4mm female to male beadless air line (6.25cm) | | 3.5mm female to male bead supported air line | | BNC male 75 Ω open | |
| 2653S3.12 | 128 | 7946A2 | 124 | 8043S5 | 128 | 8609B | 127 |
| 7mm beadless air line (3.12cm) | | 2.4mm female precision fixed offset short | | 3.5mm female to male air line (5cm) | | TNC female open | |
| 2653S15 | 128 | 8043S5.3 | 128 | 8043S5.3 | 128 | 8610B | 127 |
| 7mm beadless air line (20.0cm) | | 3.5mm female to male air line (5.3cm) | | 3.5mm female to male air line (5.3cm) | | TNC male open | |
| 7831A1 | 122 | | | | | | |
| 1.85mm female low band fixed termination | | | | | | | |

| | | | | | | | |
|---|-----|--|-----|--------------------------------------|-----|---|-----|
| 8615A | 124 | 8773B4 | 127 | 8850CK41 | 111 | G301 | 123 |
| TNC female general purpose fixed offset short | | 2.92mm (K) male open | | Type N fixed load VNA Cal kits | | Precision fixed termination | |
| 8615B | 124 | 8774S5 | 128 | 8850CK50 | 111 | G322B0.807 | 129 |
| TNC male general purpose fixed offset short | | 2.92mm (K) female to male air line (5cm) | | Type N sliding load VNA Cal kits | | Waveguide precision straight section | |
| 8650CK10 | 113 | 8774S5.25 | 128 | 8850CK51 | 111 | G340B1 | 126 |
| TNC fixed load VNA Cal kits | | 2.92mm (K) female to male air line (5.25cm) | | Type N sliding load VNA Cal kits | | Waveguide fixed offset short | |
| 8650CK11 | 113 | 8774S6 | 128 | 8850CK60 | 120 | G340B3 | 126 |
| TNC fixed load VNA Cal kits | | 2.92mm (K) female to male air line (6cm) | | Type N Verification kits | | Waveguide fixed offset short | |
| 8650CK20 | 113 | 8774S15 | 128 | 8880CK40 | 112 | G344A | 125 |
| TNC sliding load VNA Cal kits | | 2.92mm (K) female to male air line (15cm) | | 75Ω Type N VNA Calibration Kits | | Waveguide fixed flush short | |
| 8650CK21 | 113 | 8775A4 | 122 | 8880CK41 | 112 | H103A5 | 130 |
| TNC sliding load VNA Cal kits | | 2.92mm (K) female precision fixed termination | | 75Ω Type N VNA Calibration Kits | | Waveguide straight section | |
| 8680CK10 | 114 | 8775B4 | 122 | C103C5 | 130 | H301A | 123 |
| AFTNC fixed load VNA Cal kits | | 2.92mm (K) male precision fixed termination | | Waveguide straight section | | Precision fixed termination | |
| 8680CK11 | 114 | 8776C75 | 132 | C301 | 123 | H322B0.447 | 129 |
| AFTNC fixed load VNA Cal kits | | 2.92mm (K) mismatch air line | | Precision fixed termination | | Waveguide precision straight section | |
| 8680CK20 | 114 | 8778A1.20 | 131 | C322B0.539 | 129 | H340B1 | 126 |
| AFTNC sliding/fixed load VNA Cal kits | | 2.92mm (DC-40.0 GHz, 1.20 VSWR) precision mismatch | | Waveguide precision straight section | | Waveguide fixed offset short | |
| 8680CK21 | 114 | 8778A1.50 | 131 | C340F1 | 126 | H340B3 | 126 |
| AFTNC sliding/fixed load VNA Cal kits | | 2.92mm (DC-40.0 GHz, 1.50 VSWR) precision mismatch | | Waveguide fixed offset short | | Waveguide fixed offset short | |
| 8686A | 124 | 8778A2.00 | 131 | C340F3 | 126 | H344A | 125 |
| AFTNC female general purpose fixed offset short | | 2.92mm (DC-40.0 GHz, 2.00 VSWR) precision mismatch | | Waveguide fixed offset short | | Waveguide fixed flush short | |
| 8687A | 124 | 8778B1.20 | 131 | C344A | 125 | J106B1 | 130 |
| AFTNC male general purpose fixed offset short | | 2.92mm (DC-40.0 GHz, 2.00 VSWR) precision mismatch | | Waveguide fixed flush short | | Waveguide straight section | |
| 8770CK40 | 108 | 8778B1.50 | 131 | E102G5 | 130 | J301A | 123 |
| 2.92mm fixed load VNA cal kits | | 2.92mm (DC-40.0 GHz, 1.20 VSWR) precision mismatch | | Waveguide straight section | | Precision fixed termination | |
| 8770CK41 | 108 | 8778B2.00 | 131 | E301F | 123 | J322B0.0946 | 129 |
| 2.92mm fixed load VNA cal kits | | 2.92mm (DC-40.0 GHz, 1.50 VSWR) precision mismatch | | Precision fixed termination | | Waveguide precision straight section | |
| 8770CK50 | 108 | 8806A2 | 124 | E322B0.9468 | 129 | J340A1 | 126 |
| 2.92mm sliding load VNA cal kits | | Type N female precision fixed offset short | | Waveguide precision straight section | | Waveguide fixed offset short | |
| 8770CK51 | 108 | 8806G2 | 124 | E340B3 | 126 | J340B1 | 126 |
| 2.92mm sliding load VNA cal kits | | Type N female precision fixed offset short | | Waveguide fixed offset short | | Waveguide fixed offset short | |
| 8770CK60 | 120 | 8807A2 | 124 | E340B4 | 126 | K103A4 | 130 |
| 2.92mm Verification kits | | Type N male precision fixed offset short | | Waveguide fixed offset short | | Waveguide straight section | |
| 8771A2 | 124 | 8807C2 | 124 | E344B | 125 | M301A | 123 |
| 2.92mm (K) female precision fixed offset short | | Type N male precision fixed offset short | | Waveguide fixed flush short | | Precision fixed termination | |
| 8771F4 | 124 | 8809B1 | 127 | F102C5 | 130 | M322B0.311 | 129 |
| 2.92mm (K) female precision fixed offset short | | Type N female open | | Waveguide straight section | | Waveguide precision straight section | |
| 8772A2 | 124 | 8810B1 | 127 | F301C | 123 | M340C1 | 126 |
| 2.92mm (K) male precision fixed offset short | | Type N male open | | Precision fixed termination | | Waveguide fixed offset short | |
| 8772F4 | 124 | 8850CK40 | 111 | F322B0.641 | 129 | M340C3 | 126 |
| 2.92mm (K) male precision fixed offset short | | Type N fixed load VNA Cal kits | | Waveguide precision straight section | | Waveguide fixed offset short | |
| 8773A4 | 127 | | | F340C1 | 126 | M344A | 125 |
| 2.92mm (K) female open | | | | Waveguide fixed offset short | | Waveguide fixed flush short | |
| | | | | F340C3 | 126 | MT7005J99 | 143 |
| | | | | Waveguide fixed offset short | | WR229 waveguide thermal termination | |
| | | | | F344B | 125 | MT7009J99 | 143 |
| | | | | Waveguide fixed flush short | | WR51 waveguide thermal termination (hot load) | |
| | | | | G102C5 | 130 | | |
| | | | | Waveguide straight section | | | |

| | | | | | | | |
|---|-----|--------------------------------------|-----|--|-----|--|-----|
| MT7021J99 | 139 | N102F4 | 130 | S340B1 | 126 | WR51CK10 | 117 |
| WR42 waveguide cryogenic termination | | Waveguide straight section | | Waveguide fixed offset short | | VNA Cal kit SSLT, 15.0-22.0 GHz | |
| MT7022J99 | 139 | N301 | 123 | S340B2 | 126 | WR51CK12 | 117 |
| WR28 waveguide cryogenic termination | | Precision fixed termination | | Waveguide fixed offset short | | VNA Cal kit SSLT With Verification Standard, 15.0-22.0 GHz | |
| MT7023J99 | 139 | N322B0.209 | 129 | S344A | 125 | WR51CK30 | 117 |
| WR22 waveguide cryogenic termination | | Waveguide precision straight section | | Waveguide fixed flush short | | VNA Cal kit TRL, 15.0-22.0 GHz | |
| MT7025J99 | 139 | N340A | 126 | U103A4 | 130 | WR51CK32 | 117 |
| WR15 waveguide cryogenic termination | | Waveguide fixed offset short | | Waveguide straight section | | VNA Cal kit TRL With Verification Standard, 15.0-22.0 GHz | |
| MT7026J99 | 139 | N340B | 126 | U301 | 123 | WR62CK10 | 117 |
| WR12 waveguide cryogenic termination | | Waveguide fixed offset short | | Precision fixed termination | | VNA Cal kit SSLT, 12.4-18.0 GHz | |
| MT7027J99 | 139 | N344A | 125 | U322B0.118 | 129 | WR62CK12 | 117 |
| WR10 waveguide cryogenic termination | | Waveguide fixed flush short | | Waveguide precision straight section | | VNA Cal kit SSLT With Verification Standard, 12.4-18.0 GHz | |
| MT7040J99 | 139 | P103A5 | 130 | U340B | 126 | WR62CK30 | 117 |
| WR112 waveguide cryogenic termination | | Waveguide straight section | | Waveguide fixed offset short | | VNA Cal kit TRL, 12.4-18.0 GHz | |
| MT7041J99 | 139 | K301 | 123 | U340C | 126 | WR62CK32 | 117 |
| WR90 waveguide cryogenic termination | | Precision fixed termination | | Waveguide fixed offset short | | VNA Cal kit TRL With Verification Standard, 12.4-18.0 GHz | |
| MT7042J99 | 139 | K322B0.175 | 129 | U344A | 125 | WR75CK10 | 117 |
| WR75 waveguide cryogenic termination | | Waveguide precision straight section | | Waveguide fixed flush short | | VNA Cal kit SSLT, 10.0-15.0 GHz | |
| MT7043J99 | 139 | K340A1 | 126 | WR22CK10 | 117 | WR75CK12 | 117 |
| WR62 waveguide cryogenic termination | | Waveguide fixed offset short | | VNA Cal kit SSLT With Verification Standard, 33.0-50.0 GHz | | VNA Cal kit SSLT With Verification Standard, 10.0-15.0 GHz | |
| MT7044J99 | 139 | K340A2 | 126 | WR22CK12 | 117 | WR75CK30 | 117 |
| WR51 waveguide cryogenic termination | | Waveguide fixed offset short | | VNA Cal kit TRL With Verification Standard, 33.0-50.0 GHz | | VNA Cal kit TRL, 10.0-15.0 GHz | |
| MT7081J99 | 143 | K344A | 125 | WR22CK30 | 117 | WR75CK32 | 117 |
| WR90 waveguide thermal termination (hot load) | | Waveguide fixed flush short | | VNA Cal kit TRL, 33.0-50.0 GHz | | VNA Cal kit TRL With Verification Standard, 10.0-15.0 GHz | |
| MT7082J99 | 143 | K344D | 125 | WR22CK32 | 117 | WR90CK10 | 117 |
| WR75 waveguide thermal termination (hot load) | | Waveguide fixed flush short | | VNA Cal kit TRL With Verification Standard, 33.0-50.0 GHz | | VNA Cal kit SSLT, 8.20-12.4 GHz | |
| MT7084J99 | 143 | M103A5 | 130 | WR28CK10 | 117 | WR90CK12 | 117 |
| WR42 waveguide thermal termination (hot load) | | Waveguide straight section | | VNA Cal kit SSLT, 26.5-40.0 GHz | | VNA Cal kit SSLT With Verification Standard, 8.20-12.4 GHz | |
| MT7085J99 | 143 | P301A | 123 | WR28CK12 | 117 | WR90CK30 | 117 |
| WR28 waveguide thermal termination (hot load) | | Precision fixed termination | | VNA Cal kit SSLT With Verification Standard, 26.5-40.0 GHz | | VNA Cal kit TRL, 8.20-12.4 GHz | |
| MT7086J99 | 143 | P322B0.253 | 129 | WR28CK30 | 117 | WR90CK32 | 117 |
| WR22 waveguide thermal termination (hot load) | | Waveguide precision straight section | | VNA Cal kit TRL, 26.5-40.0 GHz | | VNA Cal kit TRL With Verification Standard, 8.20-12.4 GHz | |
| MT7088J99 | 143 | P340A1 | 126 | WR28CK32 | 117 | WR112CK10 | 117 |
| WR15 waveguide thermal termination (hot load) | | Waveguide fixed offset short | | VNA Cal kit TRL With Verification Standard, 26.5-40.0 GHz | | VNA Cal kit SSLT, 7.05-10.0 GHz | |
| MT7089J99 | 143 | P340A2 | 126 | WR34CK30 | 117 | WR112CK12 | 117 |
| WR12 waveguide thermal termination (hot load) | | Waveguide fixed offset short | | VNA Cal kit TRL, 22.0-33.0 GHz | | VNA Cal kit SSLT With Verification Standard, 7.05-10.0 GHz | |
| MT7090J99 | 143 | P344A | 125 | WR34CK32 | 117 | WR112CK30 | 117 |
| WR10 waveguide thermal termination (hot load) | | Waveguide fixed flush short | | VNA Cal kit TRL With Verification Standard, 22.0-33.0 GHz | | VNA Cal kit TRL, 7.05-10.0 GHz | |
| | | Q106D | 130 | WR42CK10 | 117 | WR112CK32 | 117 |
| | | Waveguide straight section | | VNA Cal kit SSLT, 18.0-26.5 GHz | | VNA Cal kit TRL With Verification Standard, 7.05-10.0 GHz | |
| | | Q301A | 123 | WR42CK12 | 117 | WR137CK10 | 117 |
| | | Precision fixed termination | | VNA Cal kit SSLT With Verification Standard, 18.0-26.5 GHz | | VNA Cal kit SSLT, 5.85-8.20 GHz | |
| | | Q322B0.1418 | 129 | WR42CK30 | 117 | | |
| | | Waveguide precision straight section | | VNA Cal kit TRL, 18.0-26.5 GHz | | | |
| | | S102C5 | 130 | WR42CK32 | 117 | | |
| | | Waveguide straight section | | VNA Cal kit TRL With Verification Standard, 18.0-26.5 GHz | | | |
| | | S301A | 123 | | | | |
| | | Precision fixed termination | | | | | |
| | | S322B1.198 | 129 | | | | |
| | | Waveguide precision straight section | | | | | |

| | | | | | | | |
|--|-----|------------------------------|-----|---|-----|--|-----|
| WR137CK12 | 117 | X340B1 | 126 | MPA-26G5-40G-25 | 171 | LLC18-N-MM | 238 |
| VNA Cal kit SSLT With Verification Standard, 5.85-8.20 GHz | | Waveguide fixed offset short | | 26.5-40 GHz, 25W Amplifier | | Low-Loss Couplers, type N male to type N male | |
| WR137CK30 | 117 | X340B3 | 126 | MPA-26G5-40G-40 | 172 | LLC34-35-FF | 238 |
| VNA Cal kit TRL, 5.85-8.20 GHz | | Waveguide fixed offset short | | 26.5-40 GHz, 40W Amplifier | | Low-Loss Couplers, 3.5mm female to 3.5mm female | |
| WR137CK32 | 117 | X344A | 125 | MPA-37G-43G-5 | 173 | LLC34-35-MF | 238 |
| VNA Cal kit TRL With Verification Standard, 5.85-8.20 GHz | | Waveguide fixed flush short | | 37-43 GHz, 5W Amplifier | | Low-Loss Couplers, 3.5mm male to 3.5mm female | |
| WR159CK10 | 117 | | | | | LLC34-35-MM | 238 |
| VNA Cal kit SSLT, 4.90-7.05 GHz | | | | | | Low-Loss Couplers, 3.5mm female to 3.5mm male | |
| WR159CK12 | 117 | | | | | LLC67-185-FF | 238 |
| VNA Cal kit SSLT With Verification Standard, 4.90-7.05 GHz | | | | | | Low-Loss Couplers, 1.85mm female to 1.85mm female | |
| WR159CK30 | 117 | MPA-0G6-6G-20 | 151 | AVCP-1 | 248 | LLC67-185-MF | 238 |
| VNA Cal kit TRL, 4.90-7.05 GHz | | 0.6-6 GHz, 20W Amplifier | | Anteverta High-Precision Current Probes | | Low-Loss Couplers, 1.85mm male to 1.85mm female | |
| WR159CK32 | 117 | MPA-0G6-6G-60 | 152 | AVCP-10 | 248 | LLC67-185-MM | 238 |
| VNA Cal kit TRL With Verification Standard, 4.90-7.05 GHz | | 0.6-6 GHz, 60W Amplifier | | Anteverta High-Precision Current Probes | | Low-Loss Couplers, 1.85mm male to 1.85mm male | |
| WR187CK10 | 117 | MPA-0G6-6G-100 | 153 | AVCP-50 | 248 | LLC75WR15 | 240 |
| VNA Cal kit TRL With Verification Standard, 4.90-7.05 GHz | | 0.6-6 GHz, 100W Amplifier | | Anteverta High-Precision Current Probes | | Low-Loss Couplers with Integrated Downconverters, WR15 to WR15 | |
| WR187CK12 | 117 | MPA-2G-6G-20 | 154 | DP-1823 | 244 | LLC90WR12 | 240 |
| VNA Cal kit SSLT, 3.95-5.85 GHz | | 2-6 GHz, 20W Amplifier | | Low-Loss Coaxial Multiplexers (1.80-2.30 GHz) | | Low-Loss Couplers with Integrated Downconverters, WR12 to WR12 | |
| WR187CK12 | 117 | MPA-2G-6G-80 | 155 | DP-2232 | 244 | LLC110WR10 | 240 |
| VNA Cal kit SSLT With Verification Standard, 3.95-5.85 GHz | | 2-6 GHz, 80W Amplifier | | Low-Loss Coaxial Multiplexers, 2.20-3.20 GHz | | Low-Loss Couplers with Integrated Downconverters, WR10 to WR10 | |
| WR187CK30 | 117 | MPA-2G-6G-100 | 156 | DP-2942 | 244 | MBT18-7-1000 | 241 |
| VNA Cal kit TRL, 3.95-5.85 GHz | | 2-6 GHz, 100W Amplifier | | Low-Loss Coaxial Multiplexers (2.90-4.20 GHz) | | High-Power Low-Loss Pulsed Bias Tees (0.35-18 GHz) | |
| WR187CK32 | 117 | MPA-2G-18G-20 | 157 | DP-3957 | 244 | MBT18-7-5000 | 241 |
| VNA Cal kit TRL With Verification Standard, 3.95-5.85 GHz | | 2-18 GHz, 20W Amplifier | | Low-Loss Coaxial Multiplexers (3.90-5.70 GHz) | | High-Power Low-Loss Pulsed Bias Tees (6-18 GHz) | |
| WR229CK10 | 117 | MPA-2G-18G-30 | 158 | DP-06810 | 244 | MBT18-NMF-5000 | 241 |
| VNA Cal kit SSLT, 3.30-4.90 GHz | | 2-18 GHz, 30W Amplifier | | Low-Loss Coaxial Multiplexers (0.68-1.00 GHz) | | High-Power Low-Loss Pulsed Bias Tees (6-18 GHz) | |
| WR229CK12 | 117 | MPA-2G-18G-50 | 159 | DP-1220 | 244 | MBT18-NFM-5000 | 241 |
| VNA Cal kit SSLT With Verification Standard, 3.30-4.90 GHz | | 2-18 GHz, 50W Amplifier | | Low-Loss Coaxial Multiplexers (1.20-2.00 GHz) | | High-Power Low-Loss Pulsed Bias Tees (6-18 GHz) | |
| WR229CK30 | 117 | MPA-6G-18G-10 | 160 | DP-5070 | 244 | MST981B35 | 231 |
| VNA Cal kit TRL, 3.30-4.90 GHz | | 6-18 GHz, 10W Amplifier | | Low-Loss Coaxial Multiplexers (5.00-7.00 GHz) | | Coaxial Slide Screw Tuner (3.5mm 0.4-4.0 GHz) | |
| WR229CK32 | 117 | MPA-6G-18G-20 | 161 | DP-7090 | 244 | MST981BN | 231 |
| VNA Cal kit TRL With Verification Standard, 3.30-4.90 GHz | | 6-18 GHz, 20W Amplifier | | Low-Loss Coaxial Multiplexers (7.00-9.00 GHz) | | Coaxial Slide Screw Tuner (Type N 0.4-4.0 GHz) | |
| WR284CK10 | 117 | MPA-6G-18G-30 | 162 | DP-8010 | 244 | MST981E35 | 231 |
| VNA Cal kit SSLT, 2.60-3.95 GHz | | 6-18 GHz, 30W Amplifier | | Low-Loss Coaxial Multiplexers (8.00-10.00 GHz) | | Coaxial Slide Screw Tuner (3.5mm 0.8-8.0 GHz) | |
| WR284CK12 | 117 | MPA-6G-18G-50 | 163 | LLC18-7 | 238 | MST981EN | 231 |
| VNA Cal kit SSLT With Verification Standard, 2.60-3.95 GHz | | 6-18 GHz, 50W Amplifier | | Low-Loss Couplers, 7mm to 7mm | | Coaxial Slide Screw Tuner (Type N 0.8-8.0 GHz) | |
| WR284CK30 | 117 | MPA-8G-12G-30 | 164 | LLC18-N-FF | 238 | MST982A35 | 231 |
| VNA Cal kit TRL, 2.60-3.95 GHz | | 8-12 GHz, 30W Amplifier | | Low-Loss Couplers, type N female to type N female | | Coaxial Slide Screw Tuner (3.5mm 1.8-18.0 GHz) | |
| WR284CK32 | 117 | MPA-8G-12G-50 | 165 | LLC18-N-MF | 238 | | |
| VNA Cal kit TRL With Verification Standard, 2.60-3.95 GHz | | 8-12 GHz, 50W Amplifier | | Low-Loss Couplers, type N female to type N female | | | |
| X103A5 | 130 | MPA-18G-26G5-10 | 166 | | | | |
| Waveguide straight section | | 18-26.5 GHz, 10W Amplifier | | | | | |
| X301A | 123 | MPA-18G-26G5-25 | 167 | | | | |
| Precision fixed termination | | 18-26.5 GHz, 25W Amplifier | | | | | |
| X322B0.382 | 129 | MPA-18G-26G5-40 | 168 | | | | |
| Waveguide precision straight section | | 18-26.5 GHz, 40W Amplifier | | | | | |
| | | MPA-26G5-40G-5 | 169 | | | | |
| | | 26.5-40 GHz, 5W Amplifier | | | | | |
| | | MPA-26G5-40G-10 | 170 | | | | |
| | | 26.5-40 GHz, 10W Amplifier | | | | | |

Test & Measurement Instrument Amplifiers Model Index

Measurement & Modeling Device Characterization Solutions Model Index

| | | | | | | | |
|--|-----|--|-----|--|-----|---|-----|
| MST982AN | 231 | MT910B | 215 | MT930M2B | 196 | MT985AL01 | 226 |
| Coaxial Slide Screw Tuner (Type N 1.8–18.0 GHz) | | AMTSv3 - WCDMA Standard | | IVCAD Nonlinear Model Extraction, LDMOS | | LXI™ 1.85mm Automated Tuner (8.0-65.0 GHz) | |
| MST982G35 | 231 | MT910C | 215 | MT930P | 198 | MT993B | 212 |
| Coaxial Slide Screw Tuner (3.5mm 0.6-18.0 GHz) | | AMTSv3 - CDMA2000 Standard | | IVCAD Measurement Toolbox | | ATSv5 - Noise Parameter Measurement Software | |
| MST982GN | 231 | MT910D | 215 | MT930Q | 198 | MT993B01 | 213 |
| Coaxial Slide Screw Tuner (Type N 0.6-18.0 GHz) | | AMTSv3 - LTE Standard | | IVCAD Stability Analysis Tool (STAN) | | ATSv5 - Ultra-Fast Noise Parameter Measurement Option | |
| MST982V35 | 231 | MT910E | 215 | MT930R1 | 199 | MT993E | 214 |
| Coaxial Slide Screw Tuner (3.5mm 0.6-8.0 GHz) | | AMTSv3 - TD-SCDMA Standard | | IVCAD EPHD Behavioral Model Extraction | | ATSv5 - Programmers Edition | |
| MST982VN | 231 | MT920A — MMW-Studio | 200 | MT940A | 96 | MT993F | 214 |
| Coaxial Slide Screw Tuner (Type N 0.6-8.0 GHz) | | High resolution power control for S-parameters and gain compression power sweep measurements | | Insight Calibration and Measurement | | ATSv5 - System Control Option | |
| MST983B35 | 231 | MT920B — MMW-Studio | 200 | MT940B | 96 | MT993G | 214 |
| Coaxial Slide Screw Tuner (3.5mm 12.0-34.0 GHz) | | mmW Studio Active load pull at millimeter-wave and sub-THz frequencies add-on | | Insight Real Time Uncertainty Add-On | | ATSv5 - DC IV Curve Option | |
| MST984A24 | 231 | MT920C — MMW-Studio | 200 | MT964A1-50 | 246 | MT993J | 214 |
| Coaxial Slide Screw Tuner (2.4mm 12.0-50.0 GHz) | | Data display | | 7mm Load Pull Test Fixture (100 MHz – 18 GHz) | | ATSv5 - Fixture Characterization Option | |
| MT902A1 | 233 | MT930B1 | 183 | MT964A2-50 | 246 | MT1000A2 | 256 |
| High-Freq. Pre-Matching Probe Mount (DC–50 GHz) | | IVCAD Basic Visualization | | 3.5mm Load Pull Test Fixture (100 MHz – 18 GHz) | | Mixed-Signal Active Load Pull System (0.3-6.0 GHz) | |
| MT902A2 | 233 | MT930B2 | 184 | MT964A3-50 | 246 | MT1000B2 | 256 |
| High-Freq. Pre-Matching Probe Mount (21.5–50 GHz) | | IVCAD Advanced Visualization Add-On | | 2.4mm Load Pull Test Fixture (100 MHz – 18 GHz) | | Mixed-Signal Active Load Pull System (0.2-18.0 GHz) | |
| MT902A3 | 233 | MT930C | 186 | MT964C1-10 | 246 | MT1000B3 | 256 |
| Low-Freq. Pre-Matching Probe Mount (8–21.5 GHz) | | IVCAD Vector-Receiver Load Pull | | 7mm Load Pull Test Fixture (800 MHz – 18 GHz) | | Mixed-Signal Active Load Pull System (0.2-18.0 GHz) | |
| MT902A5 | 233 | MT930D1 | 188 | MT964C1-50 | 246 | MT1000B4 | 256 |
| Basic Pre-Matching Probe Mount (DC–50 GHz) | | IVCAD Traditional Load Pull | | 7mm Load Pull Test Fixture (800 MHz – 18 GHz) | | Mixed-Signal Active Load Pull System (0.2-18.0 GHz) | |
| MT902A6 | 233 | MT930D2 | 188 | MT964C2-10 | 246 | MT1000B5 | 256 |
| High-Freq. Pre-Matching Probe Mount (21.5–50 GHz) | | IVCAD Harmonic, Spectrum and Vector Analyzer Add-On | | 3.5mm Load Pull Test Fixture (800 MHz – 18 GHz) | | Mixed-Signal Active Load Pull System (0.2-18.0 GHz) | |
| MT902A7 | 233 | MT930E | 189 | MT964C2-50 | 246 | MT1000B6 | 256 |
| Low-Freq. Pre-Matching Probe Mount (8–21.5 GHz) | | IVCAD DC-IV Curves | | 3.5mm Load Pull Test Fixture (800 MHz – 18 GHz) | | Mixed-Signal Active Load Pull System (0.2-18.0 GHz) | |
| MT902C1 | 233 | MT930F | 189 | MT964C3-10 | 246 | MT1000E2 | 256 |
| Basic Pre-Matching Probe Mount (DC-26.5 GHz) | | IVCAD CW S-Parameters | | 2.4mm Load Pull Test Fixture (100 MHz – 18 GHz) | | Mixed-Signal Active Load Pull System (0.7-40.0 GHz) | |
| MT902C2 | 233 | MT930GA | 190 | MT964C3-50 | 246 | MT1000E4 | 256 |
| High-Freq. Pre-Matching Probe Mount (7.3-26.5 GHz) | | IVCAD Time-Domain LSA Add-On | | 2.4mm Load Pull Test Fixture (100 MHz – 18 GHz) | | Mixed-Signal Active Load Pull System (0.7-40.0 GHz) | |
| MT902C5 | 233 | MT930GB | 190 | MT977AL | 227 | MT1000E6 | 256 |
| Basic Pre-Matching Probe Mount (DC-26.5 GHz) | | IVCAD Keysight NVNA Support Add-On | | LXI™-Certified Millimeter-Wave Automated Tuners (50.0-75.0 GHz) | | Mixed-Signal Active Load Pull System (0.7-40.0 GHz) | |
| MT902C6 | 233 | MT930H | 191 | MT978AL | 227 | MT1000HF2 | 256 |
| High-Freq. Pre-Matching Probe Mount (7.3-26.5 GHz) | | IVCAD Active Load Pull | | LXI™-Certified Millimeter-Wave Automated Tuners (60.0-90.0 GHz) | | Mixed-Signal Active Load Pull System (0.03-2.0 GHz) | |
| MT910 | 215 | MT930J | 193 | MT979AL | 227 | MT2000A2-100 | 256 |
| AMTSv3 - Automated Mobile Phone Tester | | IVCAD Pulsed IV Curves | | LXI™-Certified Millimeter-Wave Automated Tuners (75.0-110.0 GHz) | | Mixed-Signal Active Load Pull System (0.3-6.0 GHz) | |
| MT910A | 215 | MT930K | 193 | MT984AL01 | 226 | MT2000A2-200 | 256 |
| AMTSv3 - GSM Standard | | IVCAD Pulsed S-Parameters | | LXI™ 2.4mm Automated Tuner (8.0-50.0 GHz) | | Mixed-Signal Active Load Pull System (0.3-6.0 GHz) | |
| | | MT930L | 194 | | | | |
| | | IVCAD Scripting Language | | | | | |
| | | MT930M1 | 195 | | | | |
| | | IVCAD Linear Model Extraction | | | | | |
| | | MT930M2A | 196 | | | | |
| | | IVCAD Nonlinear Model Extraction, III-V | | | | | |

| | | | | | | | |
|---|-----|--|-----|--|-----|--|-----|
| MT2000A2-500 | 256 | MT2000B6-100 | 256 | MT2000HF4-100 | 256 | XT981AL14 | 223 |
| Mixed-Signal Active Load Pull System (0.3-6.0 GHz) | | Mixed-Signal Active Load Pull System (0.2-18.0 GHz) | | Mixed-Signal Active Load Pull System (0.001-2.0 GHz) | | LXI™ High-Power Automated Tuner (0.227-4.0 GHz) | |
| MT2000A2-1000 | 256 | MT2000B6-200 | 256 | MT2000HF4-200 | 256 | XT981BL10 | 223 |
| Mixed-Signal Active Load Pull System (0.3-6.0 GHz) | | Mixed-Signal Active Load Pull System (0.2-18.0 GHz) | | Mixed-Signal Active Load Pull System (0.001-2.0 GHz) | | LXI™ High-Power Automated Tuner (0.4-4.0 GHz) | |
| MT2000B2-100 | 256 | MT2000B6-500 | 256 | MT2000HF4-500 | 256 | XT981BL18 | 223 |
| Mixed-Signal Active Load Pull System (0.2-18.0 GHz) | | Mixed-Signal Active Load Pull System (0.2-18.0 GHz) | | Mixed-Signal Active Load Pull System (0.001-2.0 GHz) | | LXI™ High-Power Automated Tuner (0.4-8.0 GHz) | |
| MT2000B2-200 | 256 | MT2000E2-100 | 256 | MT7553A03 | 235 | XT981HL13 | 223 |
| Mixed-Signal Active Load Pull System (0.2-18.0 GHz) | | Mixed-Signal Active Load Pull System (0.7-40.0 GHz) | | Noise Receiver Module (01-26.5 GHz) | | LXI™ High-Gamma™ Automated Tuner (0.8-8.0 GHz) | |
| MT2000B2-500 | 256 | MT2000E2-200 | 256 | MT7553B01 | 235 | XT981HL14 | 223 |
| Mixed-Signal Active Load Pull System (0.2-18.0 GHz) | | Mixed-Signal Active Load Pull System (0.7-40.0 GHz) | | Noise Receiver Module (01-50.0 GHz) | | LXI™ High-Gamma™ Automated Tuner (1.8-8.0 GHz) | |
| MT2000B2-1000 | 256 | MT2000E2-500 | 256 | MT7553B03 | 235 | XT981HL15 | 223 |
| Mixed-Signal Active Load Pull System (0.2-18.0 GHz) | | Mixed-Signal Active Load Pull System (0.7-40.0 GHz) | | Noise Receiver Module (01-50.0 GHz) | | LXI™ High-Gamma™ Automated Tuner (0.65-6.0 GHz) | |
| MT2000B3-100 | 256 | MT2000E2-1000 | 256 | MT7553C01 | 235 | XT981ML01 | 228 |
| Mixed-Signal Active Load Pull System (0.2-18.0 GHz) | | Mixed-Signal Active Load Pull System (0.7-40.0 GHz) | | Noise Receiver Module (01-65.0 GHz) | | LXI™ Multi-Harmonic Automated Tuner (0.65-8.0 GHz) | |
| MT2000B3-200 | 256 | MT2000E4-100 | 256 | MT7553M10 | 235 | XT982ML01 | 228 |
| Mixed-Signal Active Load Pull System (0.2-18.0 GHz) | | Mixed-Signal Active Load Pull System (0.7-40.0 GHz) | | Noise Receiver Module (75.0-100.0 GHz) | | LXI™ Multi-Harmonic Automated Tuner (0.8-18.0 GHz) | |
| MT2000B3-500 | 256 | MT2000E4-200 | 256 | MT7553M12 | 235 | XT982ML03 | 228 |
| Mixed-Signal Active Load Pull System (0.2-18.0 GHz) | | Mixed-Signal Active Load Pull System (0.7-40.0 GHz) | | Noise Receiver Module (60.0-90.0 GHz) | | LXI™ Multi-Harmonic Automated Tuner (0.8-18.0 GHz) | |
| MT2000B3-1000 | 256 | MT2000E4-500 | 256 | MT7553M15 | 235 | XT982ML01 | 228 |
| Mixed-Signal Active Load Pull System (0.2-18.0 GHz) | | Mixed-Signal Active Load Pull System (0.7-40.0 GHz) | | Noise Receiver Module (50.0-75.0 GHz) | | LXI™ Multi-Harmonic Automated Tuner (0.8-18.0 GHz) | |
| MT2000B4-100 | 256 | MT2000E4-1000 | 256 | MT7553N26 | 235 | XT983ML01 | 223 |
| Mixed-Signal Active Load Pull System (0.2-18.0 GHz) | | Mixed-Signal Active Load Pull System (0.7-40.0 GHz) | | Noise Switching Module (01-26.5 GHz) | | LXI™ 3.5mm Multi-Harmonic Tuner (2.0-26.5 GHz) | |
| MT2000B4-200 | 256 | MT2000E6-100 | 256 | MT7553N50 | 235 | XT981VL10 | 223 |
| Mixed-Signal Active Load Pull System (0.2-18.0 GHz) | | Mixed-Signal Active Load Pull System (0.7-40.0 GHz) | | Noise Switching Module (01-50.0 GHz) | | LXI™ High-Power Automated Tuner (0.65-6.0 GHz) | |
| MT2000B4-500 | 256 | MT2000E6-200 | 256 | MT7553N65 | 235 | XT982AL02 | 224 |
| Mixed-Signal Active Load Pull System (0.2-18.0 GHz) | | Mixed-Signal Active Load Pull System (0.7-40.0 GHz) | | Noise Switching Module (01-65.0 GHz) | | LXI™ 7mm Automated Tuner (1.8-18.0 GHz) | |
| MT2000B4-1000 | 256 | MT2000E6-500 | 256 | TP-2226 | 244 | XT982GL01 | 224 |
| Mixed-Signal Active Load Pull System (0.2-18.0 GHz) | | Mixed-Signal Active Load Pull System (0.7-40.0 GHz) | | Precision Low-Loss Coaxial Triplexers | | LXI™ 7mm Automated Tuner (0.6-18.0 GHz) | |
| MT2000B5-100 | 256 | MT2000HF2-100 | 256 | TP-2631 | 244 | XT982GL30 | 224 |
| Mixed-Signal Active Load Pull System (0.2-18.0 GHz) | | Mixed-Signal Active Load Pull System (0.001-2.0 GHz) | | Precision Low-Loss Coaxial Triplexers | | LXI™ 7mm Automated Tuner (0.65-8.0 GHz) | |
| MT2000B5-200 | 256 | MT2000HF2-200 | 256 | TP-08710 | 244 | XT983BL01 | 225 |
| Mixed-Signal Active Load Pull System (0.2-18.0 GHz) | | Mixed-Signal Active Load Pull System (0.001-2.0 GHz) | | Precision Low-Loss Coaxial Triplexers | | LXI™ 3.5mm Automated Tuner (2.0-26.5 GHz) | |
| MT2000B5-500 | 256 | MT2000HF2-500 | 256 | TP-1822 | 244 | | |
| Mixed-Signal Active Load Pull System (0.2-18.0 GHz) | | Mixed-Signal Active Load Pull System (0.001-2.0 GHz) | | Precision Low-Loss Coaxial Triplexers | | | |
| | | | | TP-3040 | 244 | | |
| | | | | Precision Low-Loss Coaxial Triplexers | | | |
| | | | | TP-4050 | 244 | | |
| | | | | Precision Low-Loss Coaxial Triplexers | | | |
| | | | | TP-5060 | 244 | | |
| | | | | Precision Low-Loss Coaxial Triplexers | | | |

Our Mission & Values



Our Mission

Our mission is to empower our customers with state-of-the-art measurement and interconnect solutions that drive the world's best wireless communication systems.



Our Values

1. Always being part of the Solution
2. Service to our customers, partners and teammates
3. Mutual Accountability to our goals and commitments
4. Commitment to our Company Mission, Values and Objectives
5. Passion and Determination in our work
6. Nurturing our Employees' growth



About Maury Microwave

Corporate Profile

Maury and Associates was founded by Mario A. Maury, in Montclair, California on October 15, 1957. With the help of his sons, Mario A. Maury, Jr. and Marc A. Maury, the company earned a solid reputation in the microwave test, measurement and calibration industry. Today, after more than 60 years, we serve our customers as Maury Microwave Corporation. We have are dedicated to the pursuit of quality, and committed to providing the very best in customer service.

Markets Served

Maury Microwave serves all areas of the RF and microwave industry, providing a comprehensive line of automated tuners, microwave components and accessories that operate from DC to 110 GHz. This includes a wide range of test and measurement products used extensively

by the wireless communication industry for power and noise characterization of transistors and amplifiers. Our precision calibration solutions are used for test and measurement applications and production testing. Maury also produces system components for ground based and airborne applications such as communications, EW/ECM systems, and radar.

Manufacturing Technologies

Our factory is equipped with the latest 7-axis CNC machines and can handle high volume production as well as high precision, small-quantity manufacturing. We maintain a state-of-the-art microwave laboratory using the latest test equipment and vector network analyzers to support our test and calibration operations. Our in-house manufacturing and testing capabilities allow us to provide products tailored to our customers' specific requirements.

Technical Services

Our extensive knowledge and experience with calibration and measurement requirements provides the

expertise necessary for producing high quality products. Maury Calibration and Repair Services are available for every product we make, and are performed in a temperature-controlled environment with the latest in measurement and verification equipment.

Products & Technologies

Maury makes RF and microwave devices that cover a range from DC to 110 GHz, primarily addressing test and measurement applications. Coaxial components are available to 110 GHz in most popular line sizes and we also manufacture waveguide components from WR284 to WR10.

Facilities

Located in the City of Ontario, California, about 40 miles due east of Los Angeles and just north of the San Bernardino Freeway (Interstate 10), our 90,000 square foot facility is within minutes of the Ontario International Airport (ONT). Here, we make the best microwave products in the market.

General Information

How To Order Maury Products

Orders may be placed directly with the factory or in care of your nearest Maury sales representative. For orders originating outside the United States, we recommend placing the order through your local Maury sales representative. Maury maintains an extensive network of sales representatives throughout the world. To find your local Maury sales representative use the interactive index on our web site at maurymw.com/Support/find-sales-rep.php.

Pricing and Quotations

Pricing and availability for our Interconnect products can easily be found on our website via the Maury web store at <https://www.maurymw.com/store/>. Pricing requests, formal quotations, and availability for all current products are available via email or phone through our Maury sales team. Availability and pricing for special requirements must be requested through our Maury Sales team and validated through a formal Maury Microwave quotation. All formal quotations are valid for a period of 30 days from date of quote. Maury Microwave reserves the right to change prices at any time without notice.

Terms of Sale

Terms for domestic sales are N30 on receipt of invoice with approved credit application. Please refer to Maury Form 228F-1 for domestic sales terms and conditions. For international sales, please refer to Maury Form 250D-1. These forms are available on request, or may be found on our web site in PDF format.

Shipment

All shipments are at the buyer's expense. Shipments are normally made using methods and carriers specified by the customer. In the absence of specific instructions, Maury will ship at our discretion by the most advantageous method. All shipments are F.O.B. the Maury factory in Ontario, California (U.S.A.) and, unless otherwise specified, will be insured at full value at the

customer's expense. Shipments are packed to provide ample safety margin against transit damage, and there is no charge for regular packing requirements. Additional charges apply to MILSPEC preservation, packaging, packing and marking.

Product and Specifications Changes

The information, illustrations and specifications contained in this catalog were current at the time of publication. Maury Microwave is continually striving to upgrade and improve our product offering and therefore, reserves the right to change specifications, designs and models without notice and without incurring any obligation to incorporate new features on products previously sold.

Because products are changed or improved with time, please consult your local Maury representative, or our Sales Department, for current pricing and product information before placing orders.

Product Selection

Maury representatives and sales office personnel are well qualified to provide assistance in product selection, and current pricing and availability. Our factory applications engineers are ready to assist you with any technical or applications questions you may have.

Service and Support

WARRANTY

Maury Microwave is highly confident that our products will perform to the high levels that our customers have come to expect. As an expression of that confidence, our products are warranted as noted in the abbreviated warranty statements below. (For a complete statement of the hardware warranty, please see Form 228, Terms and Conditions of Sales. For a complete statement of the software warranty, please see Form 273, Maury License Agreement.)

Maury Microwave hardware products are warranted against defects in material and workmanship for a period of one year after delivery to the original purchaser. If a Maury manufactured hardware product is returned to the factory with transportation prepaid and

it is determined by Maury that the product is defective and under warranty, Maury will service the product, including repair or replacement of any defective parts thereof. This constitutes Maury's entire obligation under this warranty. Maury warrants that, for a period of ninety (90) days following purchase, software products, including firmware for use with and properly installed on a Maury designated hardware product, will operate substantially in accordance with published specifications, and that the media on which the product is supplied is free from defects in material and workmanship. Maury's sole obligation under this warranty is to repair or replace a nonconforming product and/or media, provided Maury is notified of nonconformance during the warranty period. Maury does not warrant that the operation of the product shall be uninterrupted or error-free, nor that the product will meet the needs of your specific application.

The warranty does not apply to defects arising from unauthorized modifications, misuse or improper maintenance of the product. Warranty service is available at our facility in Ontario, California.

Service Returns

Repair and calibration services are available for Maury products for as long as replacement parts are available. On some instruments, support services may be available for up to ten years.

Quality Profile

The Maury Microwave Quality Management System is Certified and Registered to AS9100D and ISO 9001:2015. The Maury Microwave Calibration System is compliant with ANSI/NCSL Z540.1.

Maury Microwave Corporation enjoys a well-earned reputation for excellent, technically advanced products that are reliable, meet specifications, and provide a quality appearance.

MAURY MICROWAVE CORPORATION IS AN ISO: 9001:2015/AS9100D CERTIFIED COMPANY.

Maury's Strategic Alliances

IN THE TEST & MEASUREMENT INDUSTRY

Working Together To Provide The Right Solutions For Your Applications



Keysight Technologies, Inc.

Keysight's electronic measurement products provide standard and customized electronic measurement instruments and systems, monitoring, management and optimization tools for communications networks and services, software design tools and related services that are used in the design, development, manufacture, installation, deployment and operation of electronics equipment and communications networks and services.

Keysight RF & Microwave test equipment allow Maury's Engineering Experts to provide customer needs with high precision and advanced services (pulsed IV/RF measurements, Load Pull characterization — CW and pulsed, two-tones, etc.), and are used to support the R&D engineers developing new characterization techniques.

Moreover, as Keysight's solutions partner Maury works closely with Keysight on the development of new applications for the PNA-X which take advantage of its advanced features and extend and enhance its capabilities into high-power, high-speed and 50 ohm environments.



AMCAD Engineering

AMCAD is a provider of new RF & Microwave solutions. Founded in 2004 with Headquarters and Lab in Limoges, France, its founders have brought together a multi-disciplinary and high skilled team.

Core Activities:

Development and provision of solutions and tools for semiconductor professionals, with emphasis on Component Measurements and Modeling, Circuit Design and Systems Behavioral Modeling. AMCAD Products include Advanced Pulsed IV / RF systems and IVCAD data management software. AMCAD's Pulsed IV/RF System is an advanced components characterization system that is essential to semiconductor

technology development, device reliability and lifetime testing, and semiconductor device modeling. Its key features include 10A-240V pulse generation, pulse widths down to 200ns, high precision current and voltage measurement, synchronized S2P capabilities to 40 GHz, and self-heating and trapping phenomena characterization; all of which makes it the idea system for modeling a wide range of devices.



Anteverta Microwave

Anteverta-mw is pioneer of large signal device characterization methodologies and systems, and high efficiency/linearity PA design. Anteverta's patented IP allows non-50Ω characterization at speeds up to 100x faster than traditional systems, and is unique in its capability of wideband impedance control for realistic modulated signals.

Anteverta microwave was launched in March 2010 as a spin-off from the Delft University of Technology in The Netherlands. Anteverta microwave was born as the development of a decade of successful research in the fields of large signal device characterization and high efficiency/linearity PA design. In May 2010 Anteverta microwave licensed its products to Maury Microwave Corporation to merge its innovative side with the strengths of the most reliable provider of non-linear characterization systems. Maury Microwave acquired Anteverta in full in March 2015.



Vertigo Technologies

Vertigo Technology provides innovative solutions for the μ wave and mm-wave test and measurement markets, by developing hardware and software tools to enhance accuracy in the fields of high mismatched (Γ) microwave measurements, planar calibrations and mm-wave large signal characterization. The company goal is to bridge the gap between conventional RF measurements and the growing need for improved accuracy, increased speed and higher frequency of operation. Vertigo Technologies developed the HF-pod, an innovative add-on for Vector Network Analysers, able to drastically improve the performance of conventional equipment in terms of accuracy when measuring devices presenting extreme impedance conditions. Other activities involve the realization of high accuracy calibration standards on fused silica substrates (FSS) for frequencies between 0 and 325 GHz, the realization of custom measurement setups for millimeter wave characterization (power control, large signal, load-pull) and dielectric spectroscopy for the characterization of (biologic) materials.

Benefits of working with Maury

*Always a win-win
relationship.*

Best-In-Class Solutions

Maury Microwave innovates for best-in-class solutions. Our solutions are proven, highly capable, with the highest accuracy and flexibility in order to help you succeed better and faster.

Expertise

We are calibration, measurement and modeling experts. Our team has been involved with calibration methodologies and standards since the invention of the VNA. Our engineers come from industry with decades of experience in hands-on measurement techniques and best practices. Our experts are at the forefront of model development and extraction.

Trust

Maury Microwave is committed to honesty; we tell it like it is. We'll bend over backwards to earn your trust and business and we won't sugarcoat or misrepresent our capabilities.

{ EMPOWER WE COMMIT TO BUILD LONG-TERM PARTNERSHIPS
BASED ON RESPECT AND TRUST. WE COMMIT TO UNDERSTAND
YOUR NEEDS AND MEET YOUR OBJECTIVES NOW AND IN THE
FUTURE. **WE EMPOWER YOU.** }

Maury Microwave Corporation AS9100D & ISO 9001:2015 Documentation

Maury Microwave Corporation is registered as conforming to AS9100D and ISO 9001:2015 for Design, Manufacturing and Servicing of Microwave Based Measuring and Testing Equipment for the Aerospace, Defense and Wireless Telecom Industries.





Calibration, Maintenance and Repair

Each Maury Microwave product is shipped with a certificate of conformance which assures that it has been tested and found to be within operational tolerances. As these products are used, changes can occur which may result in an out of tolerance condition. Periodic calibrations are therefore recommended to maintain functional integrity. We are happy to perform the calibrations you need at a reasonable cost.

At Maury Microwave, our commitment to quality doesn't end with the sale of a product. In our state-of-the-art microwave laboratory, we offer both ANSI/NCSL Z540-1 (MIL-STD-45662A) calibration and commercial level calibration services for every product we produce. Our laboratory is ANSI/NCSL Z540-1 & ISO10012:2003 compliant with traceability to NIST (National Institute of Standards and Technology).

We recommend annual re-calibration and refurbishment of your Maury products to ensure continuous measurement accuracy. Because we are the original equipment manufacturer and users of Maury products, we understand the critical performance criteria of your measurement equipment. Therefore, we will always give you an honest evaluation of each and every Maury part when repairs are required. We will also provide you with options and our best recommendation for optimum performance.

Please contact our Calibration and Repair – Measurement Services Department to obtain quotations for the specific calibration services you require. Quoted prices will cover the cost of all applicable measurements and include written calibration reports documenting the mechanical and electrical data. If parts are out of tolerance, the cost of repair or replacement will be quoted for your approval prior to the start of any additional work.

It is recommended that the following items be placed on a 12-month re-calibration cycle:

- > Calibration Kits
- > Verification Kits
- > Coaxial Components for Laboratory Use
- > Waveguide Components for Laboratory Use
- > Noise Calibration Systems (Cryogenic, Thermal and Ambient Terminations) Mechanical Products
- > Torque Wrenches
- > Connector Gages

Annual re-calibration and servicing guarantees:

- > Accuracy and Confidence in your Network Analyzer Measurements
- > Precision Connector Mating

- > Verification of Critical Mechanical and Electrical Specifications
- > All Interfaces meet "As New" Mechanical Specifications to Ensure Predictable S-Parameter Performance
- > Prolonged Life of Both Maury Measurement Standards and Your Network Analyzers
- > Confidence That Your Maury Product Will Be As Precise As When First Delivered
- > Refurbishment Done Right and Done Here In Our Factory
- > Guaranteed Genuine Maury Parts and Quality
- > We Design It, We Build It, We Calibrate It, We Repair It.

Benefits of Maury Calibration and Repair:

- > Calibration and Repairs Performed Directly By The OEM (No Middleman Delays or Mark-Ups!)
- > Complete Confidence In Your Measurements
- > Protects Your Costly Network Analyzer Investment
- > Maintains Your ANSI/ISO Compliance and NIST Traceability

Best-In-Class with Maury Microwave

1. Test port cable assemblies & metrology adapters —
the industries best VSWR spec!

2. Turnkey in-fixture characterization
of non-50Ω load pull, noise parameters & s-parameters up to 110 GHz.

3. Phase stable & amplitude cable assemblies
for all VNA applications. Maury's StabilityPlus™ — phase stability at its best!

4. Pulsed IV/RF solutions
for model development & validation — essential for GaN R&D!

5. World's fastest load pull system —
Maury's MT2000 is the only solution to control wideband impedances for modulated signals!

6. Turnkey on-wafer characterization systems
built for non-50Ω load pull, noise parameters & s-parameters up to 110 GHz!

7. Torque wrenches & connector gages —
for guaranteed interconnections!

8. The industry's best price/performance cable assemblies —
Maury's StabilityBench™ cable assemblies are ideal for every-day lab applications.

9. Lab adapters for everyday use —
Maury's Test Essentials™ offer excellent performance at the right price.

10. Coaxial & waveguide calibration kits
for all VNAs — when only mechanical calibrations will do.

11. Color-coded precision adapters —
use Maury's ColorConnect™ adapters to avoid expensive mismatch mistakes!



Exceptional Companies Have Superior Labs.

Interconnect Solutions





— INTERCONNECT SOLUTIONS

The story behind Color Connect™



We all know of engineers (not us, right?) and technicians who have at times been unsure whether two adapters mated, whether cable assemblies could be connected, and what torque wrench to use. With this uncertainty comes an underlying fear of damaging equipment, reducing measurement accuracy and wasting precious time. If only these interconnects, which are so similar to the untrained eye, could be easily labeled and identified.

John Bies of Redstone Arsenal certainly did; he lobbied the establishment to adopt a “standardized method to rapidly identify high frequency coaxial connectors.”

His report included a short list of possible results from misidentifying connectors and attempting to mate two incompatible connectors, including damaged equipment, degraded equipment reliability, degraded performance, degraded mission readiness, increased maintenance time, increased maintenance actions and lost efficiency. Additionally, even if two connectors could mate, their operational frequencies might differ, as is the case with mechanically compatible 3.5mm and 2.92mm connectors where the highest common operational frequency may only be 26.5 GHz.

John went on to state that the benefits of color-coding high frequency coaxial connectors would include the elimination of damages to equipment, a greater confidence in connector identification and use, a financial saving in training time and costs (John estimated \$5.8M and 5000 man-hours per year in the US military/government agencies alone), an increase in efficiency, reliability and readiness and an improvement in personnel safety.

An Institute of Electrical and Electronics Engineers (IEEE) Coaxial Connector Rapid ID Working Group was established in June 2008; a proposed color code schema was developed in August 2008; IEEE project authorization request P1802 was submitted for review in January 2009 and approved in May 2009. The working group is now referred to as IEEE

P287 with mandate to review the 287-2007 standards for coaxial connectors. With no other reason than selecting a familiar color scheme known to engineers across the globe, the standard resistor color-code BBROYGBVW was proposed for high frequency coaxial connectors (increasing resistor value compared to increasing frequency).

Maury Microwave has used color bands for over twenty years to identify 75ohm N Type connectors, and in 2012 decided to extend its offering with the launch of ColorConnect™ precision adapters, color-coded Stability™ cable assemblies, and TW-series torque wrenches.



Test Essentials™ Lab Adapters & ColorConnect™ Precision Adapters

AT-A-GLANCE PERFORMANCE
COMPARISON



Test Essentials™ Lab Adapters

Test Essentials™ Lab Adapters have been designed for daily use in microwave/RF labs and production facilities and offer one of the industry's best price/performance ratios. Test Essentials™ Lab Adapters feature excellent electrical performance, rugged construction for durability, repeatable mating and high reliability. Test Essentials™ Lab Adapters are available in SMA, N, 3.5mm, 2.92mm, 2.4mm and 1.85mm in-series and between-series configurations.

ColorConnect™ Precision Adapters

ColorConnect™ Precision Adapters have been designed for lab and field use where quality, performance, ease-of-identification and ease-of-use are critical. New manufacturing techniques have given ColorConnect™ Precision Adapters improved VSWR specifications bridging the gap between calibration-grade metrology adapters and daily-use lab adapters. Following the proposed IEEE high-frequency connector/adaptor color convention, ColorConnect™ Precision Adapters are the first commercially available products to offer clear indications of compatibility and intermatability. ColorConnect™ makes it a simple matter to avoid and eliminate damaged equipment, degraded equipment reliability, degraded performance and lengthy maintenance times due to improper mating (and attempted mating) of incompatible adapters. ColorConnect™ Precision Adapters are available in N Type, 3.5mm, 2.92mm, 2.4mm and 1.85mm in-series and between-series.

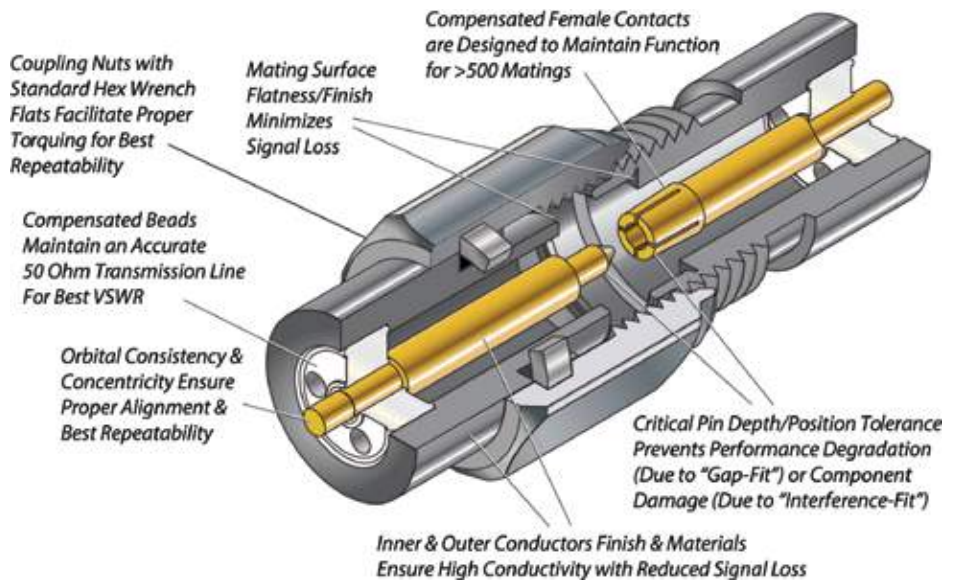

Shop Online for Test Essentials™ Lab Adapters & ColorConnect™ Precision Adapters Online at the Maury Store: (<http://www.maurymw.com/store>)

Calibration-Grade (Metrology) Adapters

Maury Microwave's comprehensive line of calibration-grade (metrology) adapters (see page 31) have been designed as an integral part of its renowned Vector Network Analyzer (VNA) Calibration Kits and are also available separately where calibration-grade precision is demanded. In-series and between series coaxial adapters are available for all precision laboratory measurement connectors – 1.85mm, 2.4mm, 2.92mm (K), 3.5mm, 7mm, 14mm, 7-16, etc.; all common systems connectors – type N, TNC, etc.; and several special purpose connector series such as EIA 7/8 rigid line connectors.

Proposed IEEE High-Frequency Connector/Adapter Color Convention (Available with Maury ColorConnect™ Precision Adapters)

| | | |
|--------|--|------------|
| BROWN |  | SMA |
| RED |  | TYPE N |
| ORANGE |  | 3.5mm |
| YELLOW |  | 2.92mm (K) |
| GREEN |  | 2.4mm |
| BLUE |  | 1.85mm (V) |

Maury Coaxial Adapter Solutions

| Connector 1 | Connector 2 | VSWR | | |
|-------------|-------------|------------------|----------------------------------|----------------------------|
| | | Test Essentials™ | | Metrology |
| | | Lab Adapters | ColorConnect™ Precision Adapters | Calibration-Grade Adapters |
| SMA (F) | SMA (F) | 1.15 | 1.15 | — |
| SMA (M) | SMA (M) | 1.15 | 1.15 | — |
| SMA (M) | SMA (F) | 1.15 | 1.15 | — |
| SMA (F) | N (F) | 1.15 | 1.14 | — |
| SMA (M) | N (M) | 1.15 | 1.14 | — |
| SMA (F) | N (M) | 1.15 | 1.14 | — |
| SMA (M) | N (F) | 1.15 | 1.14 | — |
| N (F) | N (F) | 1.20 | 1.15 | 1.09 |
| N (M) | N (M) | 1.20 | 1.15 | 1.09 |
| N (M) | N (F) | 1.20 | 1.15 | 1.09 |
| 3.5mm (F) | N (F) | 1.15 | 1.14 | 1.13 |
| 3.5mm (M) | N (M) | 1.15 | 1.14 | 1.13 |
| 3.5mm (F) | N (M) | 1.15 | 1.14 | 1.13 |
| 3.5mm (M) | N (F) | 1.15 | 1.14 | 1.13 |
| 3.5mm (F) | 3.5mm (F) | 1.20 | 1.12 | 1.08 |
| 3.5mm (M) | 3.5mm (M) | 1.20 | 1.12 | 1.08 |
| 3.5mm (M) | 3.5mm (F) | 1.20 | 1.12 | 1.08 |
| 2.4mm (F) | 3.5mm (F) | 1.15 | 1.10 | 1.08 |
| 2.4mm (M) | 3.5mm (M) | 1.15 | 1.10 | 1.08 |
| 2.4mm (F) | 3.5mm (M) | 1.15 | 1.10 | 1.08 |
| 2.4mm (M) | 3.5mm (F) | 1.15 | 1.10 | 1.08 |
| 2.92mm (F) | 2.92mm (F) | 1.17 | 1.14 | 1.12 |
| 2.92mm (M) | 2.92mm (M) | 1.17 | 1.14 | 1.12 |
| 2.92mm (M) | 2.92mm (F) | 1.17 | 1.14 | 1.12 |
| 2.4mm (F) | 2.92mm (F) | 1.17 | 1.14 | 1.12 |
| 2.4mm (M) | 2.92mm (M) | 1.17 | 1.14 | 1.12 |
| 2.4mm (F) | 2.92mm (M) | 1.17 | 1.14 | 1.12 |
| 2.4mm (M) | 2.92mm (F) | 1.17 | 1.14 | 1.12 |
| 1.85mm (F) | 2.92mm (F) | 1.17 | 1.14 | 1.12 |
| 1.85mm (M) | 2.92mm (M) | 1.17 | 1.14 | 1.12 |
| 1.85mm (F) | 2.92mm (M) | 1.17 | 1.14 | 1.12 |
| 1.85mm (M) | 2.92mm (F) | 1.17 | 1.14 | 1.12 |
| 2.4mm (F) | 2.4mm (F) | 1.22 | 1.17 | 1.15 |
| 2.4mm (M) | 2.4mm (M) | 1.22 | 1.17 | 1.15 |
| 2.4mm (M) | 2.4mm (F) | 1.22 | 1.17 | 1.15 |
| 1.85mm (F) | 1.85mm (F) | 1.30 | 1.20 | 1.15 |
| 1.85mm (M) | 1.85mm (M) | 1.30 | 1.20 | 1.15 |
| 1.85mm (M) | 1.85mm (F) | 1.30 | 1.20 | 1.15 |

Two New Maury Coaxial Adapter Solutions

Test Essentials™ Lab Adapters — In-Series



Test Essentials™ ColorConnect™ Adapters — In-Series



Available Models

| Test Essentials™ Lab Adapters | | | | |
|-------------------------------|---------------|---------------|-----------|------|
| Model | Connector 1 | Connector 2 | Frequency | VSWR |
| TE-A-SMA-FF | SMA Female | SMA Female | DC – 18.0 | 1.15 |
| TE-A-SMA-MM | SMA Male | SMA Male | DC – 18.0 | 1.15 |
| TE-A-SMA-MF | SMA Male | SMA Female | DC – 18.0 | 1.15 |
| TE-A-SMAN-FF | SMA Female | N Female | DC – 18.0 | 1.15 |
| TE-A-SMAN-MM | SMA Male | N Male | DC – 18.0 | 1.15 |
| TE-A-SMAN-FM | SMA Female | N Male | DC – 18.0 | 1.15 |
| TE-A-SMAN-MF | SMA Male | N Female | DC – 18.0 | 1.15 |
| TE-A-N-FF | N Female | N Female | DC – 18.0 | 1.20 |
| TE-A-N-MM | N Male | N Male | DC – 18.0 | 1.20 |
| TE-A-N-MF | N Male | N Female | DC – 18.0 | 1.20 |
| TE-A-35N-FF | 3.5mm Female | N Female | DC – 18.0 | 1.15 |
| TE-A-35N-MM | 3.5mm Male | N Male | DC – 18.0 | 1.15 |
| TE-A-35N-FM | 3.5mm Female | N Male | DC – 18.0 | 1.15 |
| TE-A-35N-MF | 3.5mm Male | N Female | DC – 18.0 | 1.15 |
| TE-A-35-FF | 3.5mm Female | 3.5mm Female | DC – 26.5 | 1.20 |
| TE-A-35-MM | 3.5mm Male | 3.5mm Male | DC – 26.5 | 1.20 |
| TE-A-35-MF | 3.5mm Male | 3.5mm Female | DC – 26.5 | 1.20 |
| TE-A-2435-FF | 2.4mm Female | 3.5mm Female | DC – 26.5 | 1.15 |
| TE-A-2435-MM | 2.4mm Male | 3.5mm Male | DC – 26.5 | 1.15 |
| TE-A-2435-FM | 2.4mm Female | 3.5mm Male | DC – 26.5 | 1.15 |
| TE-A-2435-MF | 2.4mm Male | 3.5mm Female | DC – 26.5 | 1.15 |
| TE-A-292-FF | 2.92mm Female | 2.92mm Female | DC – 40.0 | 1.17 |
| TE-A-292-MM | 2.92mm Male | 2.92mm Male | DC – 40.0 | 1.17 |
| TE-A-292-MF | 2.92mm Male | 2.92mm Female | DC – 40.0 | 1.17 |
| TE-A-24292-FF | 2.4mm Female | 2.92mm Female | DC – 40.0 | 1.17 |
| TE-A-24292-MM | 2.4mm Male | 2.92mm Male | DC – 40.0 | 1.17 |
| TE-A-24292-FM | 2.4mm Female | 2.92mm Male | DC – 40.0 | 1.17 |
| TE-A-24292-MF | 2.4mm Male | 2.92mm Female | DC – 40.0 | 1.17 |
| TE-A-185292-FF | 1.85mm Female | 2.92mm Female | DC – 40.0 | 1.17 |
| TE-A-185292-MM | 1.85mm Male | 2.92mm Male | DC – 40.0 | 1.17 |
| TE-A-185292-FM | 1.85mm Female | 2.92mm Male | DC – 40.0 | 1.17 |
| TE-A-185292-MF | 1.85mm Male | 2.92mm Female | DC – 40.0 | 1.17 |
| TE-A-24-FF | 2.4mm Female | 2.4mm Female | DC – 50.0 | 1.22 |
| TE-A-24-MM | 2.4mm Male | 2.4mm Male | DC – 50.0 | 1.22 |
| TE-A-24-MF | 2.4mm Male | 2.4mm Female | DC – 50.0 | 1.22 |
| TE-A-185-FF | 1.85mm Female | 1.85mm Female | DC – 67.0 | 1.30 |
| TE-A-185-MM | 1.85mm Male | 1.85mm Male | DC – 67.0 | 1.30 |
| TE-A-185-MF | 1.85mm Male | 1.85mm Female | DC – 67.0 | 1.30 |

Available Models

| ColorConnect™ Precision Adapters | | | | |
|----------------------------------|---------------|---------------|-----------|------|
| Model | Connector 1 | Connector 2 | Frequency | VSWR |
| CC-A-SMA-FF | SMA Female | SMA Female | DC – 18.0 | 1.15 |
| CC-A-SMA-MF | SMA Male | SMA Female | DC – 18.0 | 1.15 |
| CC-A-SMA-MM | SMA Male | SMA Male | DC – 18.0 | 1.15 |
| CC-A-SMAN-FF | SMA Female | N Female | DC – 18.0 | 1.14 |
| CC-A-SMAN-MM | SMA Male | N Male | DC – 18.0 | 1.14 |
| CC-A-SMAN-FM | SMA Female | N Male | DC – 18.0 | 1.14 |
| CC-A-SMAN-MF | SMA Male | N Female | DC – 18.0 | 1.14 |
| CC-A-N-FF | N Female | N Female | DC – 18.0 | 1.15 |
| CC-A-N-MM | N Male | N Male | DC – 18.0 | 1.15 |
| CC-A-N-MF | N Male | N Female | DC – 18.0 | 1.15 |
| CC-A-35N-FF | 3.5mm Female | N Female | DC – 18.0 | 1.14 |
| CC-A-35N-MM | 3.5mm Male | N Male | DC – 18.0 | 1.14 |
| CC-A-35N-FM | 3.5mm Female | N Male | DC – 18.0 | 1.14 |
| CC-A-35N-MF | 3.5mm Male | N Female | DC – 18.0 | 1.14 |
| CC-A-35-FF | 3.5mm Female | 3.5mm Female | DC – 26.5 | 1.12 |
| CC-A-35-MM | 3.5mm Male | 3.5mm Male | DC – 26.5 | 1.12 |
| CC-A-35-MF | 3.5mm Male | 3.5mm Female | DC – 26.5 | 1.12 |
| CC-A-2435-FF | 2.4mm Female | 3.5mm Female | DC – 26.5 | 1.10 |
| CC-A-2435-MM | 2.4mm Male | 3.5mm Male | DC – 26.5 | 1.10 |
| CC-A-2435-FM | 2.4mm Female | 3.5mm Male | DC – 26.5 | 1.10 |
| CC-A-2435-MF | 2.4mm Male | 3.5mm Fem | DC – 26.5 | 1.10 |
| CC-A-292-FF | 2.92mm Female | 2.92mm Female | DC – 40.0 | 1.14 |
| CC-A-292-MM | 2.92mm Male | 2.92mm Male | DC – 40.0 | 1.14 |
| CC-A-292-MF | 2.92mm Male | 2.92mm Female | DC – 40.0 | 1.14 |
| CC-A-24292-FF | 2.4mm Female | 2.92mm Female | DC – 40.0 | 1.14 |
| CC-A-24292-MM | 2.4mm Male | 2.92mm Male | DC – 40.0 | 1.14 |
| CC-A-24292-FM | 2.4mm Female | 2.92mm Male | DC – 40.0 | 1.14 |
| CC-A-24292-MF | 2.4mm Male | 2.92mm Female | DC – 40.0 | 1.14 |
| CC-A-185292-FF | 1.85mm Female | 2.92mm Female | DC – 40.0 | 1.14 |
| CC-A-185292-MM | 1.85mm Male | 2.92mm Male | DC – 40.0 | 1.14 |
| CC-A-185292-FM | 1.85mm Female | 2.92mm Male | DC – 40.0 | 1.14 |
| CC-A-185292-MF | 1.85mm Male | 2.92mm Female | DC – 40.0 | 1.14 |
| CC-A-24-FF | 2.4mm Female | 2.4mm Female | DC – 50.0 | 1.17 |
| CC-A-24-MM | 2.4mm Male | 2.4mm Male | DC – 50.0 | 1.17 |
| CC-A-24-MF | 2.4mm Male | 2.4mm Female | DC – 50.0 | 1.17 |
| CC-A-185-FF | 1.85mm Female | 1.85mm Female | DC – 67.0 | 1.20 |
| CC-A-185-MM | 1.85mm Male | 1.85mm Male | DC – 67.0 | 1.20 |
| CC-A-185-MF | 1.85mm Male | 1.85mm Female | DC – 67.0 | 1.20 |

Calibration-Grade (Metrology) Adapters



Connecting With Confidence

Test and measurement data is only as good as the system used to generate it. Good test and measurement systems rely on high-performance precision adapters to ensure proper connection between system components – connections that ensure the accuracy, repeatability, and reliability of component performance. Over the last four-and-a-half decades, Maury has earned a reputation as a leading producer of high quality, precision adapters. Today, Maury offers adapters with a wider variety of connector types and combinations than any other manufacturer.

Maury adapters feature low reflection at the interface and dielectric support, negligible electromagnetic interference, excellent connection repeatability, rugged durability, and are guaranteed to perform reliably within their specifications even after multiple connection/disconnection cycles.

When you consider the relative ease of incorporation into system designs and applications, and the value versus life-cycle cost inherent in every Maury adapter, it is easy to understand their popularity. Engineers, designers

and technicians alike know that with Maury adapters they can have the highest confidence in their component connections.

The following paragraphs describe the major categories of Maury's precision adapter line.

In-Series and Between-Series Adapters

Maury Microwave's comprehensive line of in-series and between-series coaxial adapters are available for all precision laboratory measurement connectors – 1.85mm, 2.4mm, 2.92mm (K), 3.5mm, 7mm, etc.; all common systems connectors – type N, TNC, etc.

Maury also manufactures adapters in other less common connector series not shown in this catalog. If you have a specific need and don't find a solution in these pages, please contact our Sales Department for assistance.

Phase Matched Adapters

Phase matched adapters are used in two-port VNA calibrations when the devices have same sex input and output connectors that must be tested. Through

connection for calibration is made using adapters with female and male connectors. One adapter is then replaced to permit mating to the test device. With phase matched adapters, this can be done without significantly degrading the VNA error correction capability. Phase matched in-series and between-series adapters are noted as such in the following pages.

Ruggedized Test Port Adapters

Maury Test port adapters are specifically designed to mate with the special ruggedized connectors used on commercial VNA test sets, such as those used on Keysight PNA series VNAs and Anritsu 37000 series VNAs. Maury's test port adapters can convert those connectors to other coaxial or waveguide connector types. Using Maury test port adapters as connector savers can yield significant cost savings in terms of less VNA down time and repair costs.

NMD1.85mm/ 2.4mm/2.92mm/ 3.5mm Test Port Adapters

2633, 7809, 7909, 8719, 8009, AND 8829
SERIES

Features

- > Low VSWR
- > DC to 67 GHz (Usable to 70 GHz)
- > Protects VNA Test Ports
- > Ruggedized for Long Life



Description

Maury's NMD adapters are precision, low VSWR adapters designed to connect directly to the NMD-style test ports on certain Keysight test sets and VNA models (including those in the PNA series). They are fully compatible with the VNA test ports, and adapt to precision 1.85mm, 2.4mm, 2.92mm, 3.5mm, 7mm, and type N connectors. Maury test port adapters provide the best possible connection between the VNA and other precision cables and devices. Their rugged construction provides for long life and highly stable, highly repeatable connections. They also act as test port savers, by absorbing the wear and tear that would otherwise affect the test port; preventing costly repairs and eliminating downtime.

Connector Description

The NMD1.85mm female connectors on Maury 7809 series adapters are miniature, instrument grade, air-interface connectors. Rated for operate up to 67 GHz, they are usable up to 70 GHz. They comply with IEEE standard 287 general precision connector, instrument grade GPC1.85. For interface specifications please refer to Maury data sheet 5E-089.

The NMD2.4mm female connectors on Maury 7909 series adapters are miniature, instrument grade, air-interface connectors., rated for operate up to 50 GHz. They comply with IEEE standard 287 general precision connector, instrument grade GPC2.4.) For interface specifications please refer to Maury data sheet 5E-082. The NMD male connectors are mateable to NMD female connectors via external threads, and can also mate to non-NMD connectors via internal threads.

The NMD2.92mm connectors on Maury 8719 series adapters are ruggedized test-port connectors used for stable connection to a network analyzer. The female connector is only mateable to NMD male connectors via external threads on the male nut. The NMD male connectors are mateable to NMD female connectors via external threads, and can also mate to non-NMD connectors (2.92mm, SMA, or 3.5mm) via internal threads.

The NMD3.5mm female connectors on Maury test port adapters are miniature, instrument grade, air-interface connectors., rated for operate up to 18, 20 or 26.5 GHz, according to the range of the adapted connector type. For interface specifications please refer to Maury data sheet 5E-084. The NMD male connectors on 8009F1 units are mateable to NMD female connectors via external threads, and can also mate to non-NMD connectors via internal threads.



DATA SHEET
2B-049, 2B-049A, 2B-050, 2B-051,
2B-052, 2B-053, 2B-074

NMD1.85mm/2.4mm/2.92mm/3.5mm Test Port Adapters Available Models

| MODEL | CONNECTORS | | FREQUENCY RANGE (GHz) AND MAXIMUM VSWR | INSERTION LENGTH | |
|--------|-------------------|----------------|--|------------------|---------|
| | SIDE A | SIDE B | | INCHES | (CM) |
| 7809A1 | NMD1.85mm female | 1.85mm female | DC — 26.5 ≤ 1.10 26.5 — 40.0 ≤ 1.15 40.0 — 67.0 ≤ 1.20 | 0.993 | (2.52) |
| 7809A2 | NMD1.85mm female | 1.85mm male | | 0.993 | (2.52) |
| 7809F3 | NMD1.85mm female | 2.92mm female | DC — 20.0 ≤ 1.10 20.0 — 40.0 ≤ 1.16 | 1.072 | (2.72) |
| 7809F4 | NMD1.85mm female | 2.92mm male | | 1.072 | (2.72) |
| 7809B3 | NMD1.85mm female | 3.5mm female | DC — 10.0 ≤ 1.06 10.0 — 20.0 ≤ 1.10 20.0 — 34.0 ≤ 1.12 | 1.085 | (2.76) |
| 7809B4 | NMD1.85mm female | 3.5mm male | | 1.085 | (2.76) |
| 7909A3 | NMD2.4mm female | 2.4mm female | DC — 26.5 ≤ 1.10 26.5 — 40.0 ≤ 1.15 40.0 — 50.0 ≤ 1.20 | 1.240 | (3.15) |
| 7909A4 | NMD2.4mm female | 2.4mm male | | 1.270 | (3.23) |
| 7909K1 | NMD2.4mm female | NMD2.4mm male | | 1.317 | (3.35) |
| 7909F3 | NMD2.4mm female | 2.92mm female | DC — 20.0 ≤ 1.10 20.0 — 40.0 ≤ 1.16 | 1.291 | (3.279) |
| 7909F4 | NMD2.4mm female | 2.92mm male | | 1.291 | (3.279) |
| 7909J1 | NMD2.4mm female | NMD2.92mm male | | 1.247 | (3.17) |
| 7909B3 | NMD2.4mm female | 3.5mm female | DC — 10.0 ≤ 1.06 10.0 — 20.0 ≤ 1.10 20.0 — 34.0 ≤ 1.12 | 1.060 | (2.7) |
| 7909B4 | NMD2.4mm female | 3.5mm male | | 1.020 | (2.6) |
| 7909H1 | NMD2.4mm female | NMD3.5mm male | | 1.317 | (3.35) |
| 7909C1 | NMD2.4mm female | 7mm | DC — 4.0 ≤ 1.05 4.0 — 12.0 ≤ 1.07 12.0 — 18.0 ≤ 1.10 | 2.040 | (5.18) |
| 7909D3 | NMD2.4mm female | Type N female | DC — 4.0 ≤ 1.08 4.0 — 12.0 ≤ 1.12 12.0 — 18.0 ≤ 1.14 | 1.280 | (3.25) |
| 7909D4 | NMD2.4mm female | Type N male | | 1.640 | (4.17) |
| 8719A1 | NMD 2.92mm Female | 2.92mm Female | DC — 4.0 ≤ 1.05 4.0 — 20.0 ≤ 1.08 20.0 — 40.0 ≤ 1.12 | 1.23 | (3.12) |
| 8719B1 | NMD 2.92mm Female | 2.92mm Male | | 1.23 | (3.12) |
| 8009A1 | NMD3.5mm female | 3.5mm female | DC — 18.0 ≤ 1.08 18.0 — 26.5 ≤ 1.12 | 1.450 | (3.68) |
| 8009B1 | NMD3.5mm female | 3.5mm male | | 1.490 | (3.79) |
| 8009F1 | NMD3.5mm female | NMD3.5mm male | | 1.490 | (3.79) |
| 2633C1 | NMD3.5mm female | 7mm | DC — 18.0 ≤ 1.018 + 0.003f | 1.780 | (4.53) |
| 8829A1 | NMD3.5mm female | Type N female | DC — 6.0 ≤ 1.04 6.0 — 18.0 ≤ 1.10 | 2.040 | (5.18) |
| 8829B1 | NMD3.5mm female | Type N male | | 2.200 | (5.59) |

1.85mm Adapters

IN-SERIES AND
BETWEEN-SERIES

1.85mm



7821A

7821B

7821C

2.4mm



7824A1

7824B1

7824C1

7824D1

2.92mm



7826A1

7826B1

7826C1

7826D1

3.5mm



7827A1

7827B1

7827C1

7827D1

Description

The precision adapters in these model series are designed to allow devices with 1.85mm connectors to mate with devices and cables bearing 2.4mm, 2.92mm, or 3.5mm connectors. When properly mated, they provide a low VSWR connection with low insertion loss and high repeatability. Made of highly durable materials, these adapters are ideal for use in laboratory and production environments where frequent connect/ disconnect cycles occur.

These adapters are phase matched within each model series, so that they may be easily interchanged for VNA measurement of non-insertable devices.

1.85mm Connector Description

The precision 1.85mm connectors on these adapters are miniature, instrument grade, air-interface connectors that are rated for operation from DC to 67 GHz, but may be used up to 70 GHz. They comply with IEEE standard 287 for instrument grade general precision connectors (GPC1.85).



DATA SHEET
2B-070, 2B-071,
2B-072, 2B-073

1.85mm Adapters Available Models

| MODEL | CONNECTORS | | FREQUENCY RANGE (GHz) AND MAXIMUM VSWR | INSERTION LENGTH | |
|---------------------|---------------|---------------|--|------------------|---------|
| | SIDE A | SIDE B | | INCHES | (CM) |
| 7821A ¹ | 1.85mm female | 1.85mm female | DC — 26.5 ≤ 1.06 26.5 — 40.0 ≤ 1.10 40.0 — 67.0 ≤ 1.15 | 0.750 | (1.905) |
| 7821B ¹ | 1.85mm male | 1.85mm male | | 0.750 | (1.905) |
| 7821C ¹ | 1.85mm female | 1.85mm male | | 0.750 | (1.905) |
| 7824A1 ² | 1.85mm female | 2.4mm female | DC — 26.5 ≤ 1.06 26.5 — 40.0 ≤ 1.10 40.0 — 50.0 ≤ 1.15 | 0.750 | (1.905) |
| 7824B1 ² | 1.85mm female | 2.4mm male | | 0.750 | (1.905) |
| 7824C1 ² | 1.85mm male | 2.4mm female | | 0.750 | (1.905) |
| 7824D1 ² | 1.85mm male | 2.4mm male | | 0.750 | (1.905) |
| 7826A1 ³ | 1.85mm female | 2.92mm female | DC — 4.0 ≤ 1.05 4.0 — 20.0 ≤ 1.08 20.0 — 40.0 ≤ 1.12 | 0.657 | (1.669) |
| 7826B1 ³ | 1.85mm female | 2.92mm male | | 0.657 | (1.669) |
| 7826C1 ³ | 1.85mm male | 2.92mm female | | 0.657 | (1.669) |
| 7826D1 ³ | 1.85mm male | 2.92mm male | | 0.657 | (1.669) |
| 7827A1 ⁴ | 1.85mm female | 3.5mm female | DC — 4.0 ≤ 1.05 4.0 — 26.5 ≤ 1.08 26.5 — 34.0 ≤ 1.12 | 0.657 | (1.669) |
| 7827B1 ⁴ | 1.85mm female | 3.5mm male | | 0.657 | (1.669) |
| 7827C1 ⁴ | 1.85mm male | 3.5mm female | | 0.657 | (1.669) |
| 7827D1 ⁴ | 1.85mm male | 3.5mm male | | 0.657 | (1.669) |

^{1,4} References to families that are phase matched.

2.4mm Adapters

IN-SERIES AND
BETWEEN-SERIES

2.4mm



2.92mm



3.5mm



7mm



Type N



Description

In-Series Description - Maury precision 2.4mm in-series adapters are low VSWR and low-loss devices that operate from DC to 50 GHz. The models 7921A, B and C offer combinations for in-series adapting and are phase matched, making them ideal for use in precision measurement applications. These adapters are minimum length and feature a square-flanged body for ease of connecting that also prevents them from rolling off flat surfaces. They are useful as "test port savers" when used with automated network analyzers such as the Keysight 8510, etc. The models 7921D1 and E are bulk-head and panel mount feed-thru adapters respectively, and are designed for instrumentation applications.

Between-Series Description - The precision adapters in these model series are designed to allow devices with 2.4mm connectors to mate with devices and cables bearing 2.92mm, 3.5mm, 7mm or Type N connectors. When properly mated, they provide a low VSWR connection with low insertion loss and high repeatability. Made of highly durable materials, these adapters are ideal for use in laboratory and production environments where frequent connect/disconnect cycles occur.

Except for the 7923 series, these adapters are phase matched within each model series, so that they may be easily inter-changed for VNA measurement of non-insertable devices.

2.4mm Connector Description

The precision 2.4mm connectors on these adapters are miniature, instrument grade, air-interface connectors that are rated for operation from DC to 50 GHz. They comply with IEEE standard 287 for instrument grade general precision connectors (GPC2.4).



DATA SHEET
2B-001

2.4mm Adapters Available Models

| MODEL | CONNECTORS | | FREQUENCY RANGE (GHz) AND MAXIMUM VSWR | INSERTION LENGTH | |
|---------------------------------|---------------|---------------|--|--|---------|
| | SIDE A | SIDE B | | INCHES | (CM) |
| 7921A ¹ | 2.4mm female | 2.4mm female | DC — 26.5 ≤ 1.08 26.5 — 40.0 ≤ 1.12 40.0 — 50.0 ≤ 1.15 | 0.750 | (1.905) |
| 7921B ¹ | 2.4mm male | 2.4mm male | | 0.750 | (1.905) |
| 7921C ¹ | 2.4mm female | 2.4mm male | | 0.750 | (1.905) |
| 7921D ¹ ² | 2.4mm female | 2.4mm female | | 0.860 | (2.18) |
| 7824A ³ | 1.85mm female | 2.4mm female | | 0.750 | (1.905) |
| 7824B ³ | 1.85mm female | 2.4mm male | | 0.750 | (1.905) |
| 7824C ³ | 1.85mm male | 2.4mm female | | 0.750 | (1.905) |
| 7824D ³ | 1.85mm male | 2.4mm male | | 0.750 | (1.905) |
| 7926A ⁴ | 2.4mm female | 2.92mm female | | DC — 4.0 ≤ 1.05 4.0 — 20.0 ≤ 1.08 20.0 — 40.0 ≤ 1.14 | 0.650 |
| 7926B ⁴ | 2.4mm female | 2.92mm male | 0.650 | | (1.65) |
| 7926C ⁴ | 2.4mm male | 2.92mm female | 0.650 | | (1.65) |
| 7926D ⁴ | 2.4mm male | 2.92mm male | 0.650 | | (1.65) |
| 7927A ⁵ | 2.4mm female | 3.5mm female | DC — 18.0 ≤ 1.06 18.0 — 26.5 ≤ 1.08 26.5 — 34.0 ≤ 1.12 | 0.657 | (1.669) |
| 7927B ⁵ | 2.4mm female | 3.5mm male | | 0.657 | (1.669) |
| 7927C ⁵ | 2.4mm male | 3.5mm female | | 0.657 | (1.669) |
| 7927D ⁵ | 2.4mm male | 3.5mm male | | 0.657 | (1.669) |
| 7922A ⁶ | 2.4mm female | 7mm | DC — 4.0 ≤ 1.04 4.0 — 12.0 ≤ 1.07 12.0 — 18.0 ≤ 1.10 | 1.280 | (3.25) |
| 7922B ⁶ | 2.4mm male | 7mm | | 1.280 | (3.25) |
| 7923A ⁷ | 2.4mm female | Type N female | DC — 4.0 ≤ 1.07 4.0 — 18.0 ≤ 1.12 | 1.220 | (3.10) |
| 7923B ⁸ | 2.4mm female | Type N male | | 1.580 | (4.02) |
| 7923C ⁷ | 2.4mm male | Type N female | | 1.200 | (3.05) |
| 7923D ⁸ | 2.4mm male | Type N male | | 1.560 | (3.96) |

¹⁻⁸ References to families that are phase matched.

2.92mm Adapters

IN-SERIES AND
BETWEEN-SERIES

2.92mm

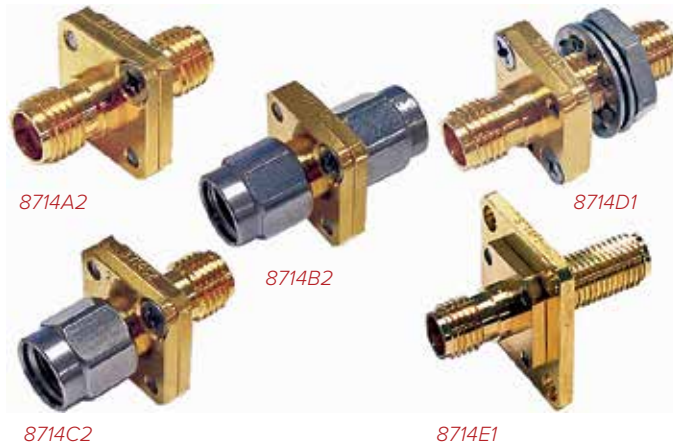

Type N



7mm



Description

In-Series Description - Maury precision 2.92mm (K) in-series adapters are low VSWR and low-loss devices that operate from DC to 40 GHz. The models 8714A2, B2 and C2 offer all combinations for adapting and are ideal for using with precision measurement applications. These adapters are minimum length, phase matched and feature a square-flange body for ease of connecting and prevents rolling off tables. They are useful as “test port savers” when used with vector network analyzers such as the Keysight 8510, etc. The 8714D1 and 8714E1 are bulkhead and panel mount feedthru adapters respectively, designed for instrumentation applications.

Between-Series Description - The precision adapters in these model series are designed to allow devices with 2.92mm connectors to mate with devices and cables bearing 7mm or Type N connectors. When properly mated, they provide a low VSWR connection with low insertion loss and high repeatability. Made of highly durable materials, these adapters are ideal for use in laboratory and production environments where frequent connect/ disconnect cycles occur.

The 8725A1 and 8725B1 adapters are phase matched to each other so that they may be easily interchanged for network analyzer measurement of non-insertable devices.

2.92mm Connector Description

The K connector was originally introduced by Maury in 1974 as the MPC3 connector and re-introduced by Wiltron in 1984 as the K connector. They comply with IEEE standard 287 general precision connector, instrument grade (GPC2.92).



DATA SHEET
2B-003, 2B-042,
2B-043

2.92mm Adapters Available Models

| MODEL | CONNECTORS | | FREQUENCY RANGE (GHz) AND MAXIMUM VSWR | INSERTION LENGTH | |
|---------------------|---------------|---------------|--|------------------|---------|
| | SIDE A | SIDE B | | INCHES | (CM) |
| 8714A2 ¹ | 2.92mm female | 2.92mm female | DC — 4.0 ≤ 1.05 4.0 — 20.0 ≤ 1.09 20.0 — 40.0 ≤ 1.13 | 0.650 | (1.65) |
| 8714B2 ¹ | 2.92mm male | 2.92mm male | | 0.650 | (1.65) |
| 8714C2 ¹ | 2.92mm female | 2.92mm male | | 0.650 | (1.65) |
| 8714D1 ² | 2.92mm female | 2.92mm female | | 0.850 | (2.15) |
| 8714E1 ² | 2.92mm female | 2.92mm female | | 0.850 | (2.15) |
| 7826A1 ³ | 1.85mm female | 2.92mm female | DC — 4.0 ≤ 1.05 4.0 — 20.0 ≤ 1.08 20.0 — 40.0 ≤ 1.12 | 0.657 | (1.669) |
| 7826B1 ³ | 1.85mm female | 2.92mm male | | 0.657 | (1.669) |
| 7826C1 ³ | 1.85mm male | 2.92mm female | | 0.657 | (1.669) |
| 7826D1 ³ | 1.85mm male | 2.92mm male | | 0.657 | (1.669) |
| 7926A ⁴ | 2.4mm female | 2.92mm female | DC — 4.0 ≤ 1.05 4.0 — 20.0 ≤ 1.08 20.0 — 40.0 ≤ 1.14 | 0.650 | (1.65) |
| 7926B1 ⁴ | 2.4mm female | 2.92mm male | | 0.650 | (1.65) |
| 7926C1 ⁴ | 2.4mm male | 2.92mm female | | 0.650 | (1.65) |
| 7926D1 ⁴ | 2.4mm male | 2.92mm male | | 0.650 | (1.65) |
| 8725A1 ⁵ | 2.92mm female | 7mm | DC — 4.0 ≤ 1.05 4.0 — 12.0 ≤ 1.07 12.0 — 18.0 ≤ 1.10 | 1.670 | (4.24) |
| 8725B1 ⁵ | 2.92mm male | 7mm | | 1.670 | (4.24) |
| 8723A ⁶ | 2.92mm female | Type N female | DC — 4.0 ≤ 1.07 4.0 — 12.0 ≤ 1.10 12.0 — 18.0 ≤ 1.17 | 1.614 | (4.099) |
| 8723B ⁷ | 2.92mm female | Type N male | | 1.914 | (5.014) |
| 8723C ⁶ | 2.92mm male | Type N female | | 1.614 | (4.099) |
| 8723D ⁷ | 2.92mm male | Type N male | | 1.914 | (5.014) |

¹⁻⁷ References to families that are phase matched.

3.5mm Adapters

IN-SERIES AND
BETWEEN-SERIES

3.5mm



8021A3

8021B3

8021C3



8021D2

8021E2

TNC



8025A1

8025C1

BNC



8023A

8028B1

Type N



8023C

8023B1

Description

In-Series Description - These precision 3.5mm adapters are low VSWR and low-loss models that operate from DC to 34 GHz. The 8021A2/B2/C2 series are designed for in-series adapting and are phase matched, making them ideal for use in precision measurement applications. They are minimum length and feature a square-flanged body to prevent them from rolling off flat surfaces. They serve as “test port savers” when used with network analyzers such as the Keysight PNA-X, etc.

Several designs are available for instrumentation applications: 8021D2 is a bulkhead feedthrough model, 8021E2 is a panel mount model.

Between-Series Description -These precision adapters are used to connect 3.5mm devices to cables or devices with the connector types listed below. Low VSWR, low insertion loss and high repeatability, make these rugged, highly durable adapters ideal for use wherever frequent connect/disconnect cycles occur. Most are phase matched within their model series.

3.5mm Connector Description

Rated from DC to 34 GHz, the precision 3.5mm miniature, air-interface connectors on these adapters comply with IEEE standard 287 for instrument grade general precision connectors (GPC3.5). See Maury data sheet 5E-062 for interface dimensions.



DATA SHEET
2B-017, 2B-017A, 2B-022, 2B-022D,
2B-022E, 2B-025, 2B-025A, 2B-028,
2B-033, 2B-034, 2B-036

3.5mm Adapters Available Models

| MODEL | CONNECTORS | | FREQUENCY RANGE (GHz) AND MAXIMUM VSWR | INSERTION LENGTH | |
|---------------------|---------------|---------------|--|------------------|---------|
| | SIDE A | SIDE B | | INCHES | (CM) |
| 8021A3 ¹ | 3.5mm female | 3.5mm female | DC — 18.0 ≤ 1.06 18.0 — 26.5 ≤ 1.09 26.5 — 34.0 ≤ 1.13 | 0.650 | (1.65) |
| 8021B3 ¹ | 3.5mm male | 3.5mm male | | 0.650 | (1.65) |
| 8021C3 ¹ | 3.5mm female | 3.5mm male | | 0.650 | (1.65) |
| 8021D2 ² | 3.5mm female | 3.5mm female | DC — 18.0 ≤ 1.07 18.0 — 26.5 ≤ 1.10 26.5 — 34.0 ≤ 1.14 | 0.850 | (2.15) |
| 8021E2 ² | 3.5mm female | 3.5mm female | | 0.850 | (2.15) |
| 7827A1 ³ | 1.85mm female | 3.5mm female | DC — 4.0 ≤ 1.05 4.0 — 26.5 ≤ 1.08 26.5 — 34.0 ≤ 1.12 | 0.657 | (1.669) |
| 7827B1 ³ | 1.85mm female | 3.5mm male | | 0.657 | (1.669) |
| 7827C1 ³ | 1.85mm male | 3.5mm female | | 0.657 | (1.669) |
| 7827D1 ³ | 1.85mm male | 3.5mm male | | 0.657 | (1.669) |
| 7927A1 ⁴ | 2.4mm female | 3.5mm female | DC — 18.0 ≤ 1.06 18.0 — 26.5 ≤ 1.08 26.5 — 34.0 ≤ 1.12 | 0.657 | (1.669) |
| 7927B1 ⁴ | 2.4mm female | 3.5mm male | | 0.657 | (1.669) |
| 7927C1 ⁴ | 2.4mm male | 3.5mm female | | 0.657 | (1.669) |
| 7927D1 ⁴ | 2.4mm male | 3.5mm male | | 0.657 | (1.669) |
| 8022S1 ⁵ | 3.5mm female | 7mm | DC — 4.0 ≤ 1.04 4.0 — 18.0 ≤ 1.09 | 1.220 | (3.10) |
| 8022T1 ⁴ | 3.5mm male | 7mm | | 1.220 | (3.10) |
| 8023A ⁶ | 3.5mm female | Type N female | DC — 4.0 ≤ 1.065 4.0 — 18.0 ≤ 1.13 | 1.620 | (4.11) |
| 8023B1 ⁶ | 3.5mm female | Type N male | | 1.620 | (4.11) |
| 8023C ⁶ | 3.5mm male | Type N female | | 1.620 | (4.11) |
| 8023D1 ⁶ | 3.5mm male | Type N male | | 1.620 | (4.11) |
| 8025A1 ⁷ | 3.5mm female | TNC female | DC — 4.0 ≤ 1.04 4.0 — 8.0 ≤ 1.14 8.0 — 18.0 ≤ 1.20 | 1.610 | (4.10) |
| 8025B1 ⁷ | 3.5mm female | TNC male | | 1.610 | (4.10) |
| 8025C1 ⁷ | 3.5mm male | TNC female | | 1.610 | (4.10) |
| 8025D1 ⁷ | 3.5mm male | TNC male | | 1.610 | (4.10) |
| 8028A1 ⁸ | 3.5mm female | BNC female | DC — 4.0 ≤ 1.10 4.0 — 10.0 ≤ 1.20 | 2.000 | (5.08) |
| 8028B1 ⁹ | 3.5mm female | BNC male | | 1.910 | (4.85) |
| 8028C1 ⁸ | 3.5mm male | BNC female | | 2.000 | (5.08) |
| 8028D1 ⁹ | 3.5mm male | BNC male | | 1.910 | (4.85) |
| 8682A1 | 3.5mm female | AFTNC female | DC — 4.0 ≤ 1.04 4.0 — 12.0 ≤ 1.06 12.0 — 20.0 ≤ 1.08 | 1.34 | (3.40) |
| 8682B1 | 3.5mm female | AFTNC male | | 1.29 | (3.28) |
| 8682C1 | 3.5mm male | AFTNC female | | 1.34 | (3.40) |
| 8682D1 | 3.5mm male | AFTNC male | | 1.29 | (3.28) |

¹⁻⁹ References to families that are phase matched.

3.5mm (QT3.5mm™) Quick Test Adapters

8006 SERIES (U.S. PATENT NO.
6,210,221)

Description

The QT3.5mm™ male connector incorporates a quick connect design that provides for a push-on/pull-off capability that mates with any commercially available 3.5mm connectors. The optional quick 1-1/2 turn twist nut combines the best of both worlds allowing quick connect or disconnect with the increased accuracy of a thread-on connector. In addition to the no nut and quick turn nut designs, a guide sleeve configuration is available to provide a self-aligning capability required in automated test stations.

The push-on connector offers excellent repeatability and long life making these adapters ideal for use in a production environment. The nut can also be torqued to 8 in. lbs making them suitable for test port applications where a calibration is required. The connectors come in four configurations: no nut, a 3/8" diameter nut, a 9/16" diameter nut, and a guide sleeve configuration.

Features

- > Quick, Easy Push-On/Pull-Off Design
- > Designed for Durability and Long Life (3,000 Connect/Disconnect Cycles)
- > Excellent Repeatability/Low VSWR
- > Guide Sleeve Design for Automated applications



8006E1
No Nut

8006E11
3/8" Nut

8006E21
9/16" Nut

8006Q1
Guide Sleeve

Repeatability*

| MODE | DC — 18 GHz | 18 — 26.5 GHz |
|----------------------|-------------|---------------|
| Push-On | > 40 dB | > 40 dB |
| Torqued to 8 in. lbs | > 50 dB | > 50 dB |
| Hand Torqued | > 50 dB | > 50 dB |

*Repeatability is based on a minimum of 3,000 connect/disconnect cycles.

Available Models

| MODEL | ADAPTS | | FREQUENCY RANGE (GHz) | MAXIMUM VSWR (GHz) |
|---------|--------------------------------------|-----------|------------------------|--|
| | SIDE A | SIDE B | | |
| 8006E1 | QT3.5mm™ (m) with no nut | 3.5mm (f) | DC — 26.5 ¹ | DC — 16.0 ≤ 1.06 16.0 — 26.5 ≤ 1.09 26.5 — 34.0 ≤ 1.13 |
| 8006E11 | QT3.5mm™ (m) with 3/8" diameter nut | | | |
| 8006E21 | QT3.5mm™ (m) with 9/16" diameter nut | | | |
| 8006Q1 | QT3.5mm™ (m) guide sleeve | | | |

¹ Slightly reduced VSWR specifications to 34 GHz.



DATA SHEET
2B-060

7mm Adapters

BETWEEN-SERIES



Description

Maury offers an extensive line of precision 7mm adapters in all common laboratory and systems connector types. 7mm adapters are also available for special purpose connections such as EIA rigid line connectors. Female and male adapters in the same connector series are phase matched for VNA applications.

7mm Connector Description

Maury precision 7mm connectors are miniature, instrument grade, air-interface connectors rated for operation from DC to 18 GHz. They comply with IEEE standard 287 for instrument grade general precision connectors (GPC7). They are normally made with gold-plated beryllium copper bodies and have a six-

slot heat treated gold-plated beryllium copper center conductor contact for improved repeatability and durability. See Maury data sheet 5E-060 for interface dimensions.

Available Models

| MODEL | CONNECTORS | | FREQUENCY RANGE (GHz) AND MAXIMUM VSWR | INSERTION LENGTH | |
|---------------------|---------------|----------------|--|------------------|--------|
| | SIDE A | SIDE B | | INCHES | (CM) |
| 7922A ¹ | 2.4mm female | 7mm | DC — 4.0 ≤ 1.04 4.0 — 12.0 ≤ 1.07 12.0 — 18.0 ≤ 1.10 | 1.280 | (3.25) |
| 7922B ¹ | 2.4mm male | 7mm | | 1.280 | (3.25) |
| 8725A ² | 2.92mm female | 7mm | DC — 4.0 ≤ 1.05 4.0 — 12.0 ≤ 1.07 12.0 — 18.0 ≤ 1.10 | 1.670 | (4.24) |
| 8725B ² | 2.92mm male | 7mm | | 1.670 | (4.24) |
| 8022S ³ | 3.5mm female | 7mm | DC — 4.0 ≤ 1.04 4.0 — 18.0 ≤ 1.09 | 1.220 | (3.10) |
| 8022T ³ | 3.5mm male | 7mm | | 1.220 | (3.10) |
| 2606C ⁴ | 7mm | Type N female | DC — 4.0 ≤ 1.04 4.0 — 9.0 ≤ 1.05 9.0 — 18.0 ≤ 1.09 | 1.510 | (3.84) |
| 2606D ⁴ | 7mm | Type N male | | 1.510 | (3.84) |
| 2622A1 | 7mm | TNC female | DC — 4.0 ≤ 1.05 4.0 — 18.0 ≤ 1.15 | 1.680 | (4.26) |
| 2622B | 7mm | TNC male | | 1.550 | (3.94) |
| 2625A ⁵ | 7mm | SMA female | DC — 4.0 ≤ 1.05 4.0 — 10.0 ≤ 1.08 10.0 — 18.0 ≤ 1.16 | 1.670 | (4.24) |
| 2625B ⁵ | 7mm | SMA male | | 1.670 | (4.24) |
| 8582D3 ⁶ | 7mm | BNC 75Ω female | DC — 12.0 ≤ 1.60 | 2.060 | (5.23) |
| 8582D4 ⁶ | 7mm | BNC 75Ω male | | 2.060 | (5.23) |

¹⁻⁶ References to families that are phase matched.



DATA SHEET
2B-030, 2Z-001,
2Z-025P, 2Z-069

Type N Adapters

IN-SERIES AND
BETWEEN-SERIES

TNC



8817B

Type N



8828A2



8828C2



8828B2

BNC



8821B1



8821A1

Description

In-Series Description - The 8828 precision type N in-series adapters feature extremely low VSWR with low insertion loss, and are phase matched (having the same electrical insertion length) so they may be readily interchanged in network analyzer measurement applications. They are constructed with aluminum bodies. Connector bodies are made from stainless steel, and the center conductors are made from gold plated, heat treated beryllium.

Between-Series Description -Maury precision type N between-series adapters are designed for general purpose laboratory use and high precision measurement applications. They exhibit low VSWR and low insertion loss across the frequency range of the adapted connector, and are built to the same rigorous quality standards as the type N in-series adapters.

Type N Connector Description

The Maury type N connectors on these adapters are precision, miniature, instrument grade, air-interface connectors, rated for operation from DC to 18 GHz. They comply with IEEE standard 287 for instrument grade general precision connectors (GPC Type N), and meet most applicable interface requirements of MIL-C-39012/1 (see footnote 2, in Figure 1 below) and they meet all applicable interface requirements of MIL-C-39012/2. The connectors will mate properly with MIL-C-71, MIL-C-39012, MIL-T-81490 and most other semi-precision type N connectors. The male connectors are provided with a 0.75-inch hex coupling nut so they can be properly torqued to 12 in. lbs. The connectors have stainless steel bodies with heat treated gold-plated beryllium copper contacts.



DATA SHEET
2B-029, 2B-006B, 2B-016, 2B-011,
2B-045, 2B-056, 2B-057, 2B-058

Type N Adapters Available Models

| MODEL | CONNECTORS | | FREQUENCY RANGE (GHz) AND MAXIMUM VSWR | INSERTION LENGTH | |
|---------------------|---------------|---------------|---|------------------|---------|
| | SIDE A | SIDE B | | INCHES | (CM) |
| 8828A2 ¹ | Type N female | Type N female | DC — 4.0 ≤ 1.04 4.0 — 10.0 ≤ 1.06 10.0 — 18.0 ≤ 1.11 | 2.500 | (6.35) |
| 8828B2 ¹ | Type N male | Type N male | | 2.500 | (6.35) |
| 8828C2 ¹ | Type N female | Type N male | | 2.500 | (6.35) |
| 7923A | 2.4mm female | Type N female | DC — 4.0 ≤ 1.07 4.0 — 18.0 ≤ 1.12 | 1.220 | (3.10) |
| 7923B | 2.4mm female | Type N male | | 1.580 | (4.02) |
| 7923C | 2.4mm male | Type N female | | 1.200 | (3.05) |
| 7923D | 2.4mm male | Type N male | | 1.560 | (3.96) |
| 8723A ² | 2.92mm female | Type N female | DC — 4.0 ≤ 1.07 4.0 — 12.0 ≤ 1.10 12.0 — 18.0 ≤ 1.17 | 1.614 | (4.099) |
| 8723B ³ | 2.92mm female | Type N male | | 1.914 | (5.014) |
| 8723C ² | 2.92mm male | Type N female | | 1.614 | (4.099) |
| 8723D ³ | 2.92mm male | Type N male | | 1.914 | (5.014) |
| 8023A ⁴ | 3.5mm female | Type N female | DC — 4.0 ≤ 1.065 4.0 — 18.0 ≤ 1.13 | 1.620 | (4.11) |
| 8023B1 ⁴ | 3.5mm female | Type N male | | 1.620 | (4.11) |
| 8023C ⁴ | 3.5mm male | Type N female | | 1.620 | (4.11) |
| 8023D1 ⁴ | 3.5mm male | Type N male | | 1.620 | (4.11) |
| 2606C ⁵ | 7mm | Type N female | DC — 4.0 ≤ 1.04 4.0 — 9.0 ≤ 1.05 9.0 — 18.0 ≤ 1.09 | 1.510 | (3.84) |
| 2606D ⁵ | 7mm | Type N male | | 1.510 | (3.84) |
| 8817A | Type N female | TNC female | DC — 4.0 ≤ 1.065 4.0 — 8.0 ≤ 1.10 8.0 — 12.0 ≤ 1.12 12.0 — 18.0 ≤ 1.14 | 1.170 | (2.97) |
| 8817B | Type N female | TNC male | | 1.500 | (3.81) |
| 8817C | Type N male | TNC female | | 1.530 | (3.89) |
| 8817D | Type N male | TNC male | | 1.86 | (4.72) |
| 8821A1 | Type N female | BNC female | DC — 4.0 ≤ 1.08 4.0 — 10.0 ≤ 1.20 | 2.370 | (6.02) |
| 8821B1 | Type N female | BNC male | | 2.010 | (5.11) |
| 8821C1 | Type N male | BNC female | | 2.460 | (6.25) |
| 8821D1 | Type N male | BNC male | | 2.100 | (5.33) |

¹⁻⁷ References to families that are phase matched.

TNC Adapters

IN-SERIES AND
BETWEEN-SERIES



Description

Because TNC interfaces vary from maker to maker, compatibility must be verified before connectors of different specification types are mated. Mating different specification types degrades electrical performance and risks damage to connector interfaces. Maury application note 5A-031 discusses the most common TNC connectors and compatibility issues that arise if specification types are mixed. See also Maury data sheet 5E-057A to check the compatibility of your TNC connectors.

TNC Connector Descriptions

Maury offers two precision TNC connector designs:

MPC/TNC – Precision TNC connectors that mate with most commercially available TNC connectors and specifically with MIL-C-39012/26/27 test connectors or MIL-T-81490 connectors. This design is also used with some modifications – in the 232A2/B2/C2 models.

These adapters are recommended for use with dielectrically loaded TNC interfaces. Because they are ideal for use in VNA application these adapters are

provided in Maury 8650CK series VNA calibration kits (see page 113).

Models 232A2/B2/C2 are designed per the Maury 5E-053A interface standard; an improved MPC/TNC version that is mating compatible with all common military and IEC specification TNC connectors. This includes MIL-STD-348A standard and test connectors (which replace MIL-C-39012 connectors), MIL-T-81490, and IEC 169-17 G0 and G2 connectors.

All 232 series adapters exhibit low VSWR when properly mated and are usable to 18 GHz.

Available Models

| MODEL | CONNECTORS | | FREQUENCY RANGE (GHz) AND MAXIMUM VSWR | INSERTION LENGTH | |
|--------|---------------|------------|---|------------------|--------|
| | SIDE A | SIDE B | | INCHES | (CM) |
| 232A1 | TNC female | TNC female | DC – 4.0 ≤ 1.06 4.0 – 7.0 ≤ 1.10 7.0 – 18.0 ≤ 1.14 | 1.350 | (3.43) |
| 232B1 | TNC male | TNC male | | 1.350 | (3.43) |
| 232C1 | TNC female | TNC male | | 1.350 | (3.43) |
| 232A2 | TNC female | TNC female | DC – 4.0 ≤ 1.06 4.0 – 7.0 ≤ 1.10 7.0 – 18.0 ≤ 1.14 | 1.350 | (3.43) |
| 232B2 | TNC male | TNC male | | 1.350 | (3.43) |
| 232C2 | TNC female | TNC male | | 1.350 | (3.43) |
| 8025A1 | 3.5mm female | TNC female | DC – 4.0 ≤ 1.04 4.0 – 8.0 ≤ 1.14 8.0 – 18.0 ≤ 1.20 | 1.610 | (4.10) |
| 8025B1 | 3.5mm female | TNC male | | 1.610 | (4.10) |
| 8025C1 | 3.5mm male | TNC female | | 1.610 | (4.10) |
| 8025D1 | 3.5mm male | TNC male | | 1.610 | (4.10) |
| 2622A1 | 7mm | TNC female | DC – 4.0 ≤ 1.05 4.0 – 18.0 ≤ 1.15 | 1.680 | (4.26) |
| 2622B | 7mm | TNC male | | 1.550 | (3.94) |
| 8817A | Type N female | TNC female | DC – 4.0 ≤ 1.065 4.0 – 8.0 ≤ 1.10 8.0 – 12.0 ≤ 1.12 12.0 – 18.0 ≤ 1.14 | 1.170 | (2.97) |
| 8817B | Type N female | TNC male | | 1.500 | (3.81) |
| 8817C | Type N male | TNC female | | 1.530 | (3.89) |
| 8817D | Type N male | TNC male | | 0.186 | (4.72) |



DATA SHEET
2B-007, 2B-046

BNC & SMA Adapters

BNC Connector Description

Maury BNC series connectors are 75-ohm or 50-ohm impedance connectors with two-stud bayonet coupling. These connectors conform to MIL-C-39012. The connectors are normally made with stainless steel bodies with heat treated gold plated beryllium copper contacts.

SMA Connector Description

The Maury SMA connectors are miniature, instrument grade, dielectric loaded interface connectors that are rated for operation from DC to 18 GHz. They comply with Mil-C-39012. NOTE: SMA connectors, 3.5mm connectors, and 2.92mm connectors are mateable.

Available Models

| MODEL | CONNECTORS | | FREQUENCY RANGE (GHz) AND MAXIMUM VSWR | INSERTION LENGTH | |
|----------------------|---------------|----------------|--|------------------|--------|
| | SIDE A | SIDE B | | INCHES | (CM) |
| 8028A ¹ | 3.5mm female | BNC 50Ω female | DC — 4.0 ≤ 1.10 4.0 — 10.0 ≤ 1.20 | 2.000 | (5.08) |
| 8028B ^{1,2} | 3.5mm female | BNC 50Ω male | | 1.910 | (4.85) |
| 8028C ¹ | 3.5mm male | BNC 50Ω female | | 2.000 | (5.08) |
| 8028D ^{1,2} | 3.5mm male | BNC 50Ω male | | 1.910 | (4.85) |
| 2625A ³ | 7mm | SMA female | DC — 4.0 ≤ 1.05 4.0 — 10.0 ≤ 1.08 10.0 — 18.0 ≤ 1.16 | 1.670 | (4.24) |
| 2625B ³ | 7mm | SMA male | | 1.670 | (4.24) |
| 8582D3 ⁴ | 7mm | BNC 75Ω female | DC — 12.0 ≤ 1.60 | 2.060 | (5.23) |
| 8582D4 ⁴ | 7mm | BNC 75Ω male | | 2.060 | (5.23) |
| 8821A1 | Type N female | BNC 50Ω female | DC — 4.0 ≤ 1.08 4.0 — 10.0 ≤ 1.20 | 2.100 | (5.33) |
| 8821B1 | Type N female | BNC 50Ω male | | 2.010 | (5.11) |
| 8821C1 | Type N male | BNC 50Ω female | | 2.460 | (6.25) |
| 8821D1 | Type N male | BNC 50Ω male | | 2.370 | (6.02) |

¹⁻⁴ References to families that are phase matched.

Waveguide-To-Coaxial Adapters — Right Angle Launch

WR90–WR22 TO 2.4MM, 2.92MM, 3.5MM, 7MM, AND TYPE N



7mm
P209D8

3.5mm
N200A8

2.92mm
U211C6

General Information

Maury produces a comprehensive lines of waveguide to coaxial adapters. Our adapters set the standards for high precision laboratory test and measurement applications, and for systems applications where accuracy and durability are important. These adapters feature precision index holes and lapped flanges to facilitate proper mating; ensuring that your system will deliver the critical performance demanded by the most exacting measurement tasks.

Maury waveguide to coaxial adapters include right angle and end launch configurations. They are available in all common waveguide sizes, covering frequencies from 8.2 to 50 GHz. They adapt to 2.4mm, 2.92mm, 3.5mm, 7mm, and type N coaxial connector types.

Description

Maury right angle launch adapters feature low VSWR and low insertion loss. Except where noted, flanges are in accordance with the listing on page 133. Most of the adapters shown incorporate precision index holes in the flange for precise mating alignment and connection repeatability. Please consult the factory for detailed flange interface information.

Specifications

Frequency Range -- 8.2 – 50.0 GHz (in waveguide bands)

Flanges -- Cover Type, see page 133

VSWR Options

Improved VSWR is provided on adapters with a numeric suffix to the model number (e.g., X200A8).

| Model Suffix | Maximum VSWR |
|--------------|--------------|
| 8 | 1.07 |
| 1 | 1.10 |
| 6 | 1.15 |
| 3 | 1.20 |

Many adapters can be provided with improved VSWR over their full or partial waveguide bands. Our Sales Department will gladly assist you with this and other application specific requirements. Information on specific models such as loss, power handling and dimensions will be provided on request.

Waveguide-To-Coaxial Adapters — Right Angle Launch

Available Models

Right Angle Launch EIA WR to 2.4mm, 2.92mm and 3.5mm Connectors

| FREQUENCY RANGE (GHz) | EIA WR NUMBER | MODEL (BY COAXIAL CONNECTOR TYPE) | | | | | |
|-----------------------|---------------|-----------------------------------|------------|---------------|-------------|--------------|------------|
| | | 2.4mm female | 2.4mm male | 2.92mm female | 2.92mm male | 3.5mm female | 3.5mm male |
| 8.20 – 12.40 | 90 | — | — | — | — | X200A8 | X200B8 |
| 10.00 – 15.00 | 75 | — | — | — | — | M200A8 | M200B8 |
| 12.40 – 18.00 | 62 | — | — | — | — | P200A8 | P200B8 |
| 15.00 – 22.00 | 51 | — | — | — | — | N200A8 | N200B8 |
| 18.00 – 26.50 | 42 | K236A1 | K236B1 | — | — | K200A1 | K200B1 |
| 22.00 – 33.00 | 34 | Q236A1 | Q236B1 | — | — | Q200A3 | Q200B3 |
| 26.50 – 40.00 | 28 | U236A6 | U236B6 | U210C6 | U211C6 | — | — |
| 33.00 – 50.00 | 22 | J236A3 | J236B3 | — | — | — | — |

Right Angle Launch EIA WR to 7mm and Type N Connectors

| FREQUENCY RANGE (GHz) | EIA WR NUMBER | MODEL (BY COAXIAL CONNECTOR TYPE) | | |
|-----------------------|---------------|-----------------------------------|---------------|-------------|
| | | 7mm | Type N female | Type N male |
| 8.20 – 12.40 | 90 | X209D8 | X213D8 | X214D8 |
| 10.00 – 15.00 | 75 | M209D8 | M213D8 | M214D8 |
| 12.40 – 18.00 | 62 | P209D8 | P213D8 | P214D8 |

Waveguide-To-Coaxial Adapters — End Launch

WR430–WR22 TO 2.4MM, 2.92MM, 3.5MM, 7MM,
AND TYPE N



K233B8
WR42 -to-2.92mm
Male

U237A1
WR28 -to-2.4mm
Female

General Information

Maury produces a comprehensive lines of waveguide to coaxial adapters. Our adapters set the standards for high precision laboratory test and measurement applications, and for systems applications where accuracy and durability are important. These adapters feature precision index holes and lapped flanges to facilitate proper mating; ensuring that your system will deliver the critical performance demanded by the most exacting measurement tasks.

Maury waveguide to coaxial adapters include right angle and end launch configurations. They are available in all common rectangular waveguide sizes, covering frequencies from 8.2 to 50 GHz. They adapt to 2.4mm, 2.92mm, 3.5mm, 7mm, type N and SMA coaxial connector types.

Description

Maury end launch adapters feature low VSWR and low insertion loss. Except where noted, flanges are in accordance with the listing on page 133. Most of the adapters shown incorporate precision index holes in the flange for precise mating alignment and connection repeatability. Please contact us for detailed flange interface information.

Specifications

Frequency Range -- 2.8 – 50.0 GHz (in waveguide bands)

Flanges -- Cover Type, see page 133

VSWR Options

Improved VSWR is provided on adapters with a numeric suffix to the model number (e.g., X230A1).

| Model Suffix | Maximum VSWR |
|--------------|--------------|
| 8 | 1.07 |
| 1 | 1.10 |
| 6 | 1.15 |
| 3 | 1.20 |

Many adapters can be provided with improved VSWR over their full or partial waveguide bands. Our Sales Department will gladly assist you with this and other application specific requirements. Information on specific models such as loss, power handling and dimensions will be provided on request.

Waveguide-To-Coaxial Adapters — End Launch

Available Models

End Launch EIA WR to 2.4mm, 2.92mm, and 3.5mm Connectors

| FREQUENCY RANGE (GHz) | EIA WR NUMBER | MODEL (BY COAXIAL CONNECTOR TYPE) | | | | | |
|-----------------------|---------------|-----------------------------------|------------|---------------|-------------|--------------|------------|
| | | 2.4mm female | 2.4mm male | 2.92mm female | 2.92mm male | 3.5mm female | 3.5mm male |
| 8.20 – 12.40 | 90 | — | — | — | — | X230A1 | X230B1 |
| 10.00 – 15.00 | 75 | — | — | — | — | M230A1 | M230B1 |
| 12.40 – 18.00 | 62 | — | — | — | — | P230A8 | P230B8 |
| 15.00 – 22.00 | 51 | — | — | — | — | N230A3 | N230B3 |
| 18.00 – 26.50 | 42 | K237A8 | K237B8 | K233A8 | K233B8 | K230A6 | K230B6 |
| 22.00 – 33.00 | 34 | Q237A8 | Q237B8 | — | — | — | — |
| 26.50 – 40.00 | 28 | U237A1 | U237B1 | U233A1 | U233B1 | — | — |
| 33.00 – 50.00 | 22 | J237A6 | J237B6 | — | — | — | — |

End Launch EIA WR to 7mm and Type N Connectors

| FREQUENCY RANGE (GHz) | EIA WR NUMBER | MODEL (BY COAXIAL CONNECTOR TYPE) | | |
|-----------------------|---------------|-----------------------------------|---------------|-------------|
| | | 7mm | Type N female | Type N male |
| 8.20 – 12.40 | 90 | X229A8 | X221A8 | X221B8 |
| 10.00 – 15.00 | 75 | M229A8 | M221A8 | M221B8 |
| 12.40 – 18.00 | 62 | P229A8 | P221A8 | P221B8 |

Space Qualified Adapters

Maury Microwave offers an extensive line of precision Space Qualified waveguide-to-coaxial adapters for use in satellite communications and other space applications. Our unique designs, special materials, plating and coating processes, enable us to produce adapters that operate with optimum performance and reliability under the extreme conditions encountered in space. Maury Space Qualified adapters are available in right angle and end launch versions and can be provided in many waveguide size and

connector configurations. Weight-saving designs, custom flanges and beadless versions for harsh radiation exposure are also available, with full band or optimized narrow band performance ranges. These adapters can be qualified under Group A/B/C environmental testing, including Thermal Shock, Vibration, Operating Temperature Extremes, and EMI — all tailored to your exact specifications. Please call our Sales Department for more information.



N232P01

N233P01

N233P02

N234P02

Test Port Cable Assemblies

Features and Benefits

- > Industry's best phase stability with flexure improves measurement accuracy and ensures repeatable and reliable measurements
- > Superior flexibility and anti-skid band ensures the cables can be arbitrarily positioned with no spring-back or stress on DUT
- > Increased crush resistance and flex cycles enhances longevity and can lead to years of uninterrupted use
- > Color-coded connectors reduce potential for connection mistakes
- > The best amplitude and phase stability reduces measurement uncertainty and increases confidence in measurements
- > Standard lengths and connector configurations in stock; custom lengths and configurations available



Available Models - Cable Assemblies

| Connector | Model Number | Connector Type 1 | Connector Type 2 | Cable Length | | Frequency Range (GHz) |
|-----------------|----------------|---------------------|-------------------|--------------|-------|-----------------------|
| | | | | Inches | CM | |
| 1.85mm | SV-185-FM-25 | NMD 1.85mm - Female | NMD 1.85mm - Male | 25 | 63.5 | DC - 67 |
| | SV-185-FF-25 | | 1.85mm - Female | | | |
| | SV-185-FM-38 | | NMD 1.85mm - Male | 38 | 96.5 | |
| | SV-185-FF-38 | | 1.85mm - Female | | | |
| | SV-185-FM-48 | | NMD 1.85mm - Male | 48 | 121.9 | |
| | SV-185-FF-48 | | 1.85mm - Female | | | |
| 2.4mm | SV-24-FM-25 | NMD 2.4mm - Female | NMD 2.4mm - Male | 25 | 63.5 | DC - 50 |
| | SV-24-FF-25 | | 2.4mm - Female | | | |
| | SV-24-FM-38 | | NMD 2.4mm - Male | 38 | 96.5 | |
| | SV-24-FF-38 | | 2.4mm - Female | | | |
| | SV-24-FM-48 | | NMD 2.4mm - Male | 48 | 121.9 | |
| | SV-24-FF-48 | | 2.4mm - Female | | | |
| 2.92mm | SV-292-FM-25 | NMD 2.92mm - Female | NMD 2.92mm - Male | 25 | 63.5 | DC - 40 |
| | SV-292-FF-25 | | 2.92mm - Female | | | |
| | SV-292-FM-38 | | NMD 2.92mm - Male | 38 | 96.5 | |
| | SV-292-FF-38 | | 2.92mm - Female | | | |
| | SV-292-FM-48 | | NMD 2.92mm - Male | 48 | 121.9 | |
| | SV-292-FF-48 | | 2.92mm - Female | | | |
| 2.4mm to 2.92mm | SV-24292-FM-25 | NMD 2.4mm - Female | NMD 2.92mm - Male | 25 | 63.5 | DC - 40 |
| | SV-24292-FF-25 | | 2.92mm - Female | | | |
| | SV-24292-FM-38 | | NMD 2.92mm - Male | 38 | 96.5 | |
| | SV-24292-FF-38 | | 2.92mm - Female | | | |
| | SV-24292-FM-48 | | NMD 2.92mm - Male | 48 | 121.9 | |
| | SV-24292-FF-48 | | 2.92mm - Female | | | |
| 3.5mm | SV-35-FM-25 | NMD 3.5mm - Female | NMD 3.5mm - Male | 25 | 63.5 | DC - 26.5 |
| | SV-35-FF-25 | | 3.5mm - Female | | | |
| | SV-35-FM-38 | | NMD 3.5mm - Male | 38 | 96.5 | |
| | SV-35-FF-38 | | 3.5mm - Female | | | |
| | SV-35-FM-48 | | NMD 3.5mm - Male | 48 | 121.9 | |
| | SV-35-FF-48 | | 3.5mm - Female | | | |

Stability Specifications

| StabilityVNA™ Cable Type | Frequency | Length | Typical Phase Stability with Flexure | Typical Amplitude Stability with Flexure |
|--------------------------|-----------|--------|--------------------------------------|--|
| SV-185 | 67 GHz | 25" | ±4.0° | ±0.05 dB |
| | | 38" | ±5.0° | ±0.07 dB |
| SV-24 | 50 GHz | 25" | ±2.0° | ±0.02 dB |
| | | 38" | ±4.0° | ±0.03 dB |
| SV-292 | 40 GHz | 25" | ±2.0° | ±0.02 dB |
| | | 38" | ±3.0° | |
| SV-35 | 26.5 GHz | 25" | ±2.0° | ±0.02 dB |
| | | 38" | | |



DATA SHEET
2Z-002

Electrical Specifications

| StabilityVNA™ Cable Type | SV-185 | | | SV-24 | | | SV-292 and SV-24292 | | | SV-35 | | |
|-------------------------------------|-----------------------|------|------|------------|------|------|---------------------|------|------|------------|------|------|
| Maximum Frequency | 67 GHz | | | 50 GHz | | | 40 GHz | | | 26.5 GHz | | |
| Typical Insertion Loss (cable only) | 1.79 dB/ft | | | 1.00 dB/ft | | | 0.89 dB/ft | | | 0.72 dB/ft | | |
| VSWR (typical) | 1.35:1 | | | 1.25:1 | | | 1.25:1 | | | 1.18:1 | | |
| VSWR (maximum) | 1.40:1 | | | 1.35:1 | | | 1.32:1 | | | 1.25:1 | | |
| Cable Length (in) | 25 | 38 | 48 | 25 | 38 | 48 | 25 | 38 | 48 | 25 | 38 | 48 |
| Typical Insertion Loss (dB) | 4.36 | 6.35 | 7.88 | 2.70 | 3.79 | 4.62 | 2.41 | 3.37 | 4.11 | 1.95 | 2.73 | 3.32 |
| Max Insertion Loss (dB) | 4.69 | 6.68 | 8.21 | 2.98 | 4.07 | 4.90 | 2.66 | 3.62 | 4.37 | 2.16 | 2.93 | 3.53 |
| Typical Phase Stability (degree) | 4.0 | 5.0 | 7.0 | 2.0 | 4.0 | | 2.0 | 3.0 | | 2.0 | | 3.0 |
| Max Phase Stability (degree) | 7.0 | 9.0 | | 3.5 | 8.0 | | 3.0 | 6.0 | | 2.7 | 5.5 | |
| Typical Amplitude Stability (dB) | 0.05 | 0.07 | | 0.02 | 0.03 | | 0.02 | | 0.03 | 0.02 | | 0.03 |
| Max Amplitude Stability (dB) | 0.15 | 0.20 | | 0.08 | 0.10 | 0.13 | 0.08 | 0.10 | | 0.08 | 0.10 | |
| Impedance (nominal) | 50 ohm | | | | | | | | | | | |
| Velocity of Propagation | 74% (nominal) | | | | | | | | | | | |
| Shielding Effectiveness | >100 dB (DC - 18 GHz) | | | | | | | | | | | |
| Time Delay (nominal) | 1.34 ns/ft (4.5 ns/m) | | | | | | | | | | | |

Mechanical Specifications

| StabilityVNA™ Cable Type | SV-185 | | | SV-24 | | | SV-292 and SV-24292 | | | SV-35 | | |
|--------------------------------|---------------------------------|------------------------|------------------------|------------------------|------------------------|------------------------|------------------------|------------------------|------------------------|------------------------|------------------------|------------------------|
| Cable Outer Diameter (nominal) | 0.6 in (15.1mm) | | | | | | | | | | | |
| Cable Length (in) | 25 | 38 | 48 | 25 | 38 | 48 | 25 | 38 | 48 | 25 | 38 | 48 |
| Nominal Weight | 11.1 oz/ft (315g/m) | 13.6 oz/ft (385g/m) | 16.1 oz/ft (455g/m) | 11.1 oz/ft (315g/m) | 13.6 oz/ft (385g/m) | 16.1 oz/ft (455g/m) | 11.1 oz/ft (315g/m) | 13.6 oz/ft (385g/m) | 16.1 oz/ft (455g/m) | 11.1 oz/ft (315g/m) | 13.6 oz/ft (385g/m) | 16.1 oz/ft (455g/m) |
| Flex Life Cycles (typical) | >50,000 | | | | | | | | | | | |
| Min. Bend Radius | 2.00 in (50mm) | | | | | | | | | | | |
| Crush Resistance | >839 lbsf/in (150 kgf/cm) | | | | | | | | | | | |
| Operating Temperature Range | 64.4°F to 82.4°F (18°C to 28°C) | | | | | | | | | | | |

Maury StabilityVNA™ Cable Assembly Typical Performance

Maury StabilityVNA™
38" Cable Assembly
Typical VSWR

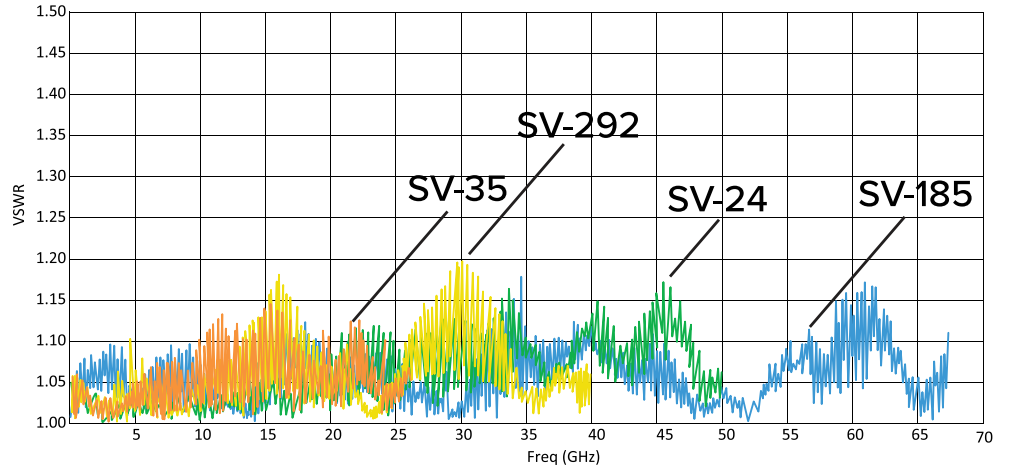

Maury StabilityVNA™ 38"
Cable Assembly Typical
Insertion Loss

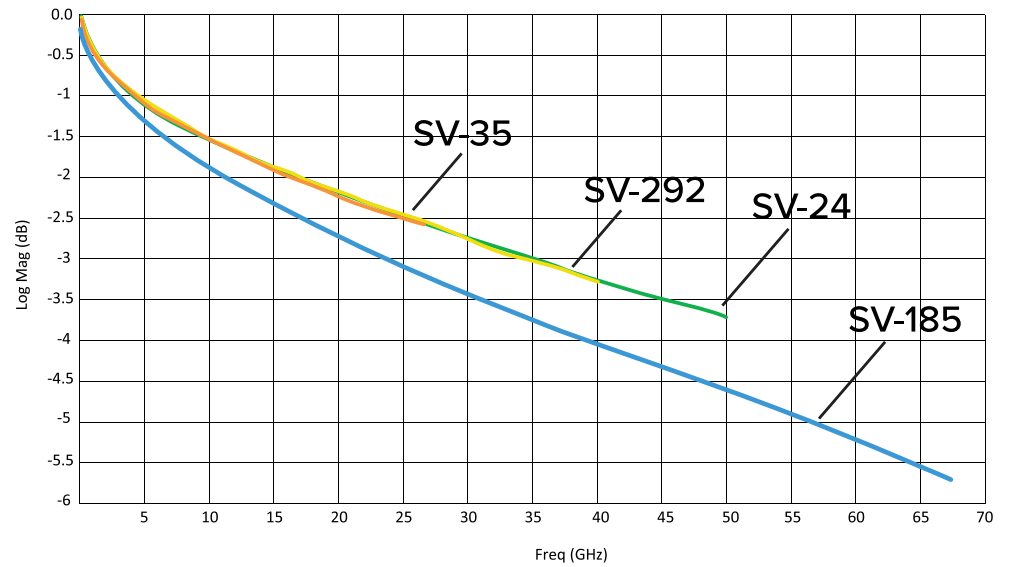

StabilityPlus™ Dimensions

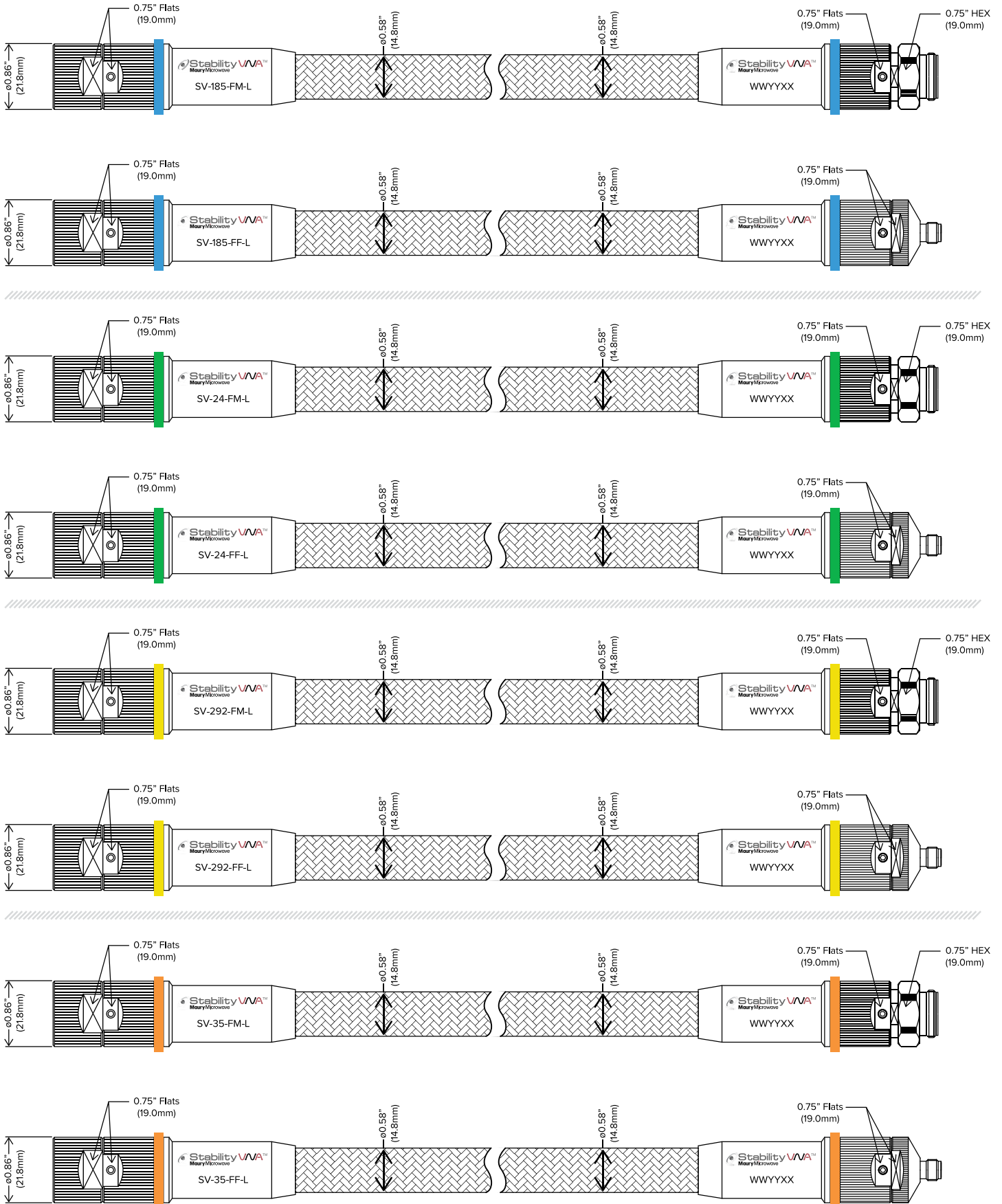

Phase Stability

The maximum value for phase and amplitude stability was established using the following method. The cable was terminated with a short. With the cable in a straight position the VNA was normalized. The cable was coiled 180° around a mandrel 4 inches in diameter counter-clockwise and held in position for one sweep. The maximum deviation over the frequency range was recorded. The cable was then coiled 180° around the mandrel clockwise and held in position for one sweep and the maximum deviation was recorded. The cable was then returned to its original position for one sweep and the maximum deviation was recorded.

The plots on the right show the recorded worst-case phase variation.

Exemplary data for SV-185-FM-38

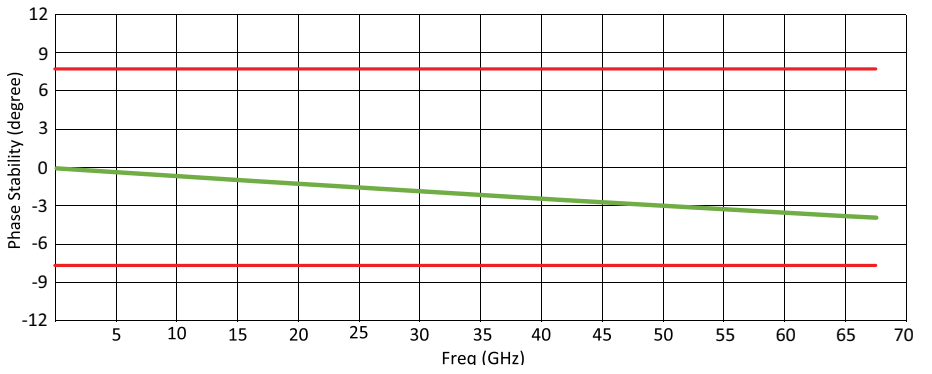

Exemplary data for SV-24-FM-38

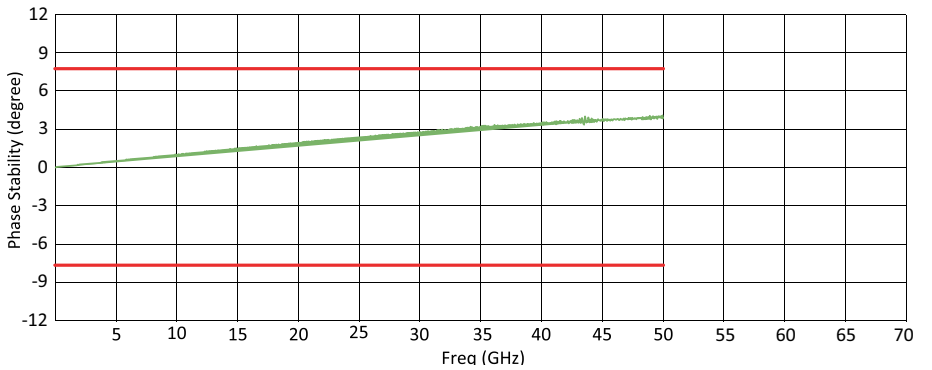

Exemplary data for SV-292-FM-38

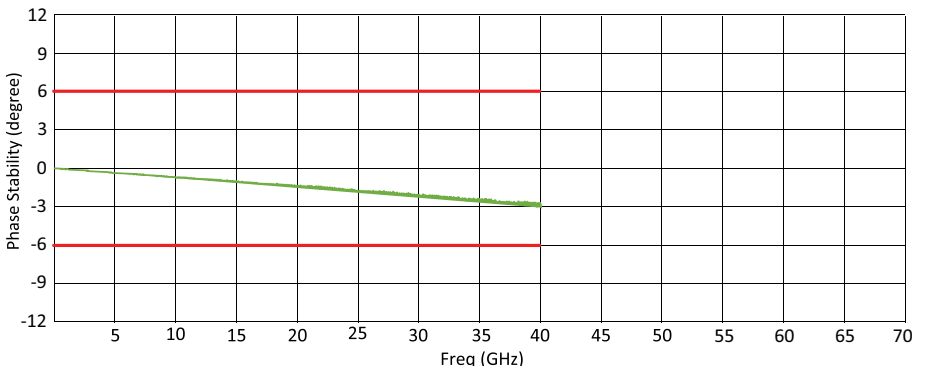

Exemplary data for SV-35-FM-38

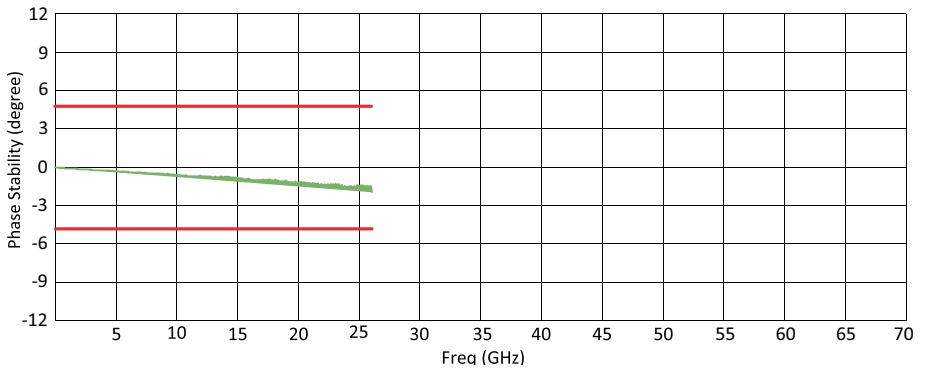

S-parameter measurements with uncertainty

A cable's *phase stability with flexure* specification is a metric used to communicate the impact of cable movement on a DUT measurement. It implies that lower specifications lessen the impact on the measurement (i.e. a cable with a 2° phase stability with flexure specification will have a lesser impact on a measurement than a cable with a 5° phase stability). However, the methods used to determine this specification may not be consistent across manufacturers, and likely do not represent the actual cable movement range of a user.

A better metric to understand a cable's impact on a DUT measurement is "uncertainty contribution". The cable's impact on measurement uncertainty can be calculated by moving the cable through a user's actual range of motion and recording the S-parameters across the movement. This technique has been thoroughly documented by the European Association of National Metrology Institutes (EURAMET)* and has been made commercially available in Maury's Insight^{TM**} calibration and measurement software platform.

The plots on the right show typical S-parameter measurements with uncertainty boundaries on different types of DUTs. The boundaries shown only consider the cable's direct contribution on measurement uncertainty.

* <https://www.maurymw.com/pdf/I-CAL-GUI-012.pdf>

** https://www.maurymw.com/Precision/Insight_Software.php

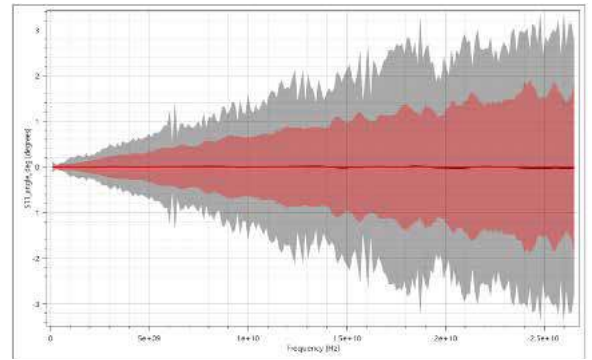

S11_{phase} measured on a short circuit termination SV-35-FM-38 shown in red; leading global competitor shown in grey

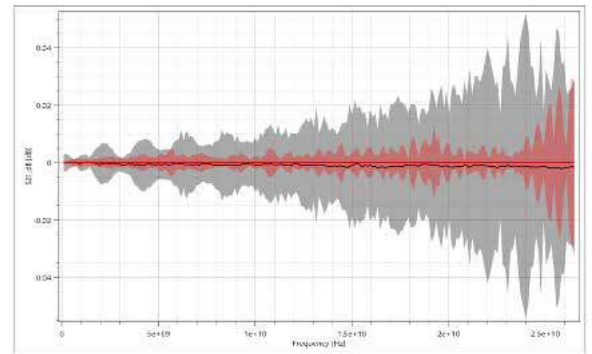

S21_{mag} measured on a short circuit termination SV-35-FM-38 shown in red; leading global competitor shown in grey

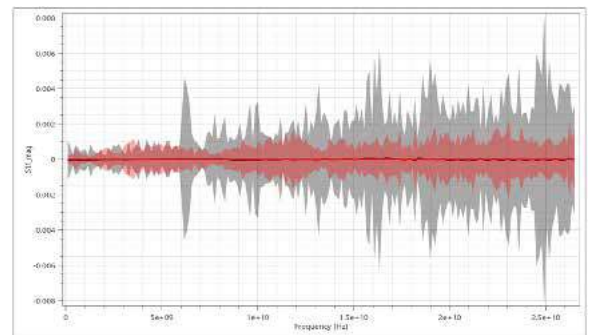

S11_{mag} measured on a short circuit termination SV-35-FM-38 shown in red; leading global competitor shown in grey



Ordering Instructions for StabilityVNA™ Cable Assemblies

Standard StabilityVNA™ Cable Assemblies

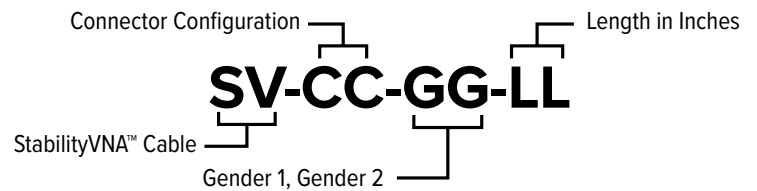

| CC | GG | LL (Standard Lengths) |
|--------------|---|-----------------------|
| 35 (3.5mm) | FM (NMD Female to NMD Male) FF (NMD Female to Standard Female) | 25 |
| 292 (2.92mm) | | 38 |
| 24 (2.4mm) | | 48 |
| 185 (1.85mm) | | |

NOTE: Custom lengths and configurations available

EXAMPLE:

The following is a StabilityVNA™ cable assembly with 3.5mm NMD Female to NMD Male connectors, and 38 inches overall length.

Configuration Sample

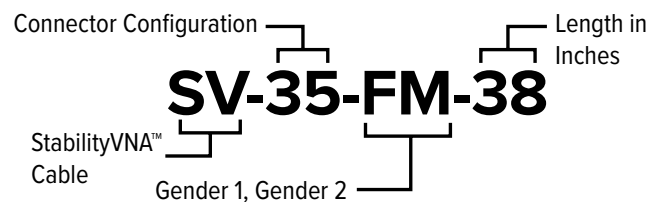

EXAMPLE:

The following is a StabilityVNA™ cable assembly with 2.4mm NMD Female connector on one end and 2.92mm NMD Male connector on the other end, and 38 inches overall length.

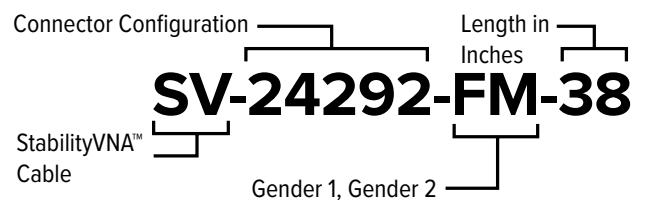

StabilityPlus™ Microwave/RF Cable Assemblies

SERIES SP-185 , SP-24, SP-292, SP-35, SP-N AND SP-TNCA

Features and Benefits

- > Industry's best phase stability with flexure
- > Amplitude stable with flexure
- > Increased flexibility
- > Reliable and repeatable measurements
- > Longer flex life

Typical Applications

- > Vector network analyzers (VNAs)
- > RF and microwave instruments
- > Bench-top testing
- > RF production testing
- > ATE systems



Description

Maury Microwave's StabilityPlus™ series sets the standard for high-performance ruggedized cable assemblies. Designed specifically for phase-stable and amplitude-stable applications, StabilityPlus™ offers excellent measurement repeatability even after cable flexure. StabilityPlus™ light weight, superior flexibility and small form factor make it ideal for daily use with VNA's, test instruments, bench-top testing and ATE systems.

StabilityPlus™ cable assemblies are now part of the ColorConnect™ family! Following the proposed IEEE high-frequency connector/adaptor color convention, StabilityPlus™ cable assemblies are the first commercially available assemblies to offer clear indications of compatibility and intermatability. ColorConnect™ makes it a simple matter to avoid and eliminate damaged equipment, degraded equipment reliability, degraded performance and lengthy maintenance times due to improper mating (and attempted mating) of incompatible interconnects.

Stability Specifications

| StabilityPlus™ Cable Type | Frequency | Typical Phase Stability with Flexure | Typical Amplitude Stability with Flexure |
|---------------------------|-----------|--------------------------------------|--|
| SP-185 | 67 GHz | ±8° | ±0.15 dB |
| SP-24 | 50 GHz | ±6° | ±0.05 dB |
| SP-292 | 40 GHz | ±4.5° | ±0.05 dB |
| SP-35 | 26.5 GHz | ±3° | ±0.05 dB |
| SP-N | 18 GHz | ±2° | ±0.05 dB |
| SP-TNCA | 18 GHz | ±2° | ±0.05 dB |



DATA SHEET
2Z-009

Standard Cable Assembly Specifications

| StabilityPlus™ Cable Type | SP-185 | SP-24 | SP-292 | SP-35 | SP-N | SP-TNCA |
|--|------------------------|---------------|------------|------------|------------|---------|
| Maximum Frequency | 67 GHz | 50 GHz | 40 GHz | 26.5 GHz | 18 GHz | |
| VSWR (typical) | 1.40:1 | 1.30:1 | 1.25:1 | | | |
| Typical Insertion Loss (cable only) | 1.79 dB/ft | 1.00 dB/ft | 0.89 dB/ft | 0.72 dB/ft | 0.61 dB/ft | |
| Impedance (nominal) | 50 ohm | | | | | |
| Phase Stability vs Flexure (typical) | ±8° | ±6° | ±4.5° | ±3° | ±2° | |
| Phase Stability vs Flexure (maximum) | ±14° | ±10.5° | ±8.5° | ±5.5° | ±4.2° | |
| Amplitude Stability vs Flexure (typical) | ±0.15 dB | ±0.05 dB | | | | |
| Amplitude Stability vs Flexure (maximum) | ±0.20 dB | ±0.10 dB | | | | |
| Phase Stability vs Temp | <4°/m/GHz (-55°+105°C) | | | | | |
| Velocity of Propagation | 74% (nominal) | 76% (nominal) | | | | |
| Shielding Effectiveness | >100 dB (DC - 18 GHz) | | | | | |
| Time Delay (nominal) | 1.34 ns/ft (4.5 ns/m) | | | | | |

Mechanical / Environmental Properties

| StabilityPlus™ Cable Type | SP-185 | SP-24, SP-292, SP-35 | SP-N | SP-TNCA |
|--|---------------------------------|-------------------------|--------------|------------------|
| Center Conductor Material | Silver Plated Copper | | | |
| Maximum Outer Diameter (Connector) | 0.42 in (10.7mm) | 0.49 in (12.5mm) | 0.870 (22mm) | 0.64in (16.25mm) |
| Maximum Outer Diameter (Cable) | 0.2 in. (5mm) | 0.25 in (6.35mm) | | |
| Nominal Weight | 0.677 oz/ft (63g/m) | 0.97 oz/ft (90g/m) | | |
| Min. Static Bend Radius/ Min. Dynamic Bend Radius | 1.0 in (25.4mm)/2.0 in (50.8mm) | | | |
| Flex Life Cycles | >15,000 | | | |
| Connector Mating Cycles | >5,000 | | | |
| Crush Resistance | >254 lbf/in (44 kgf/cm) | >305 lbf/in (54 kgf/cm) | | |
| Operating Temperature Range | -67°F to 221°F (-55°C to 105°C) | | | |
| RoHS/REACH | Yes | | | |

Maury StabilityPlus™ Cable Assembly Typical Performance

Maury StabilityPlus™
36" Cable Assembly
Typical VSWR

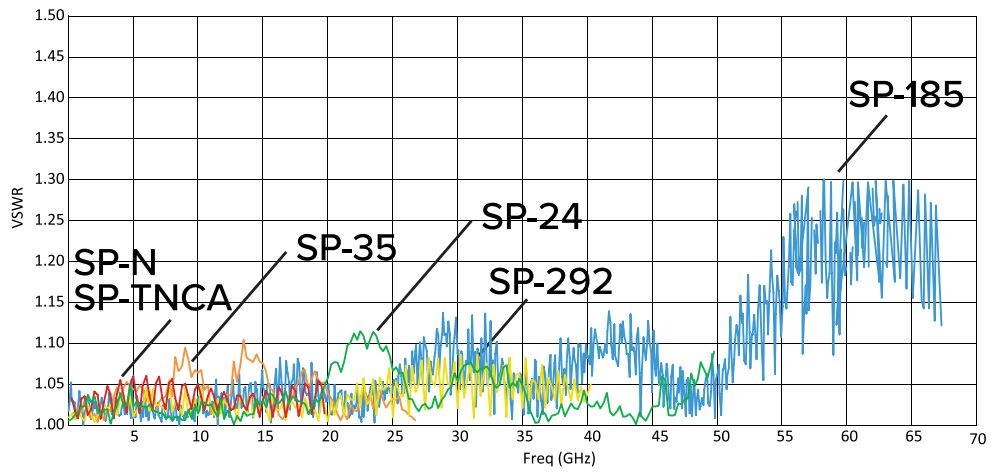

Maury StabilityPlus™ 36"
Cable Assembly Typical
Insertion Loss

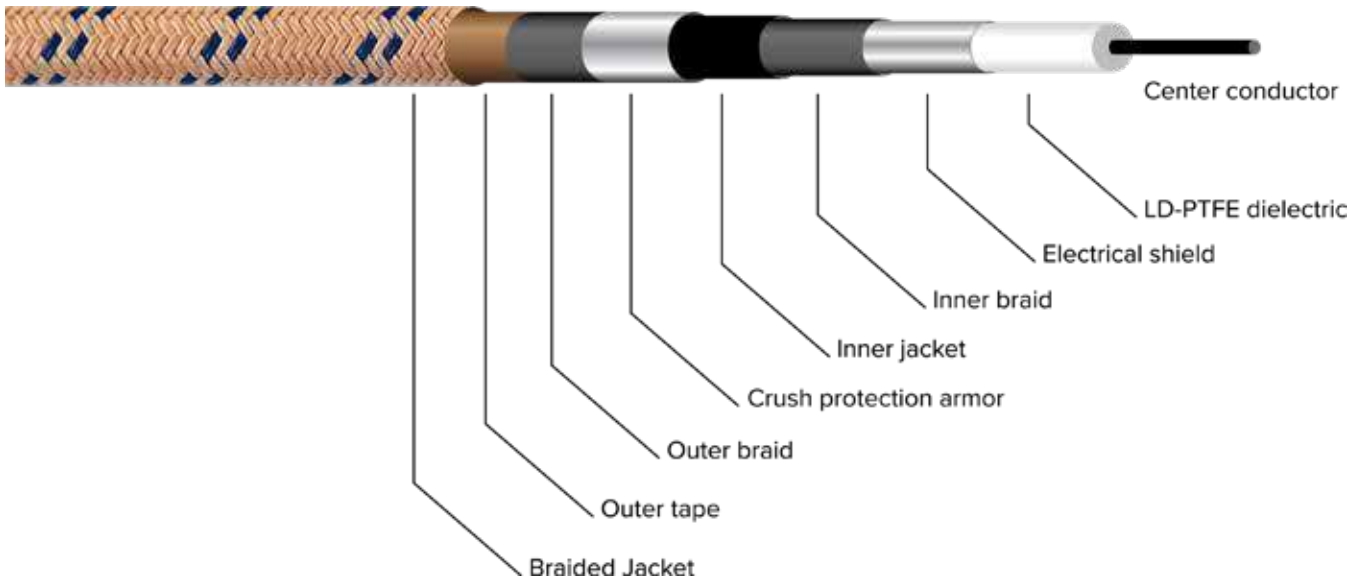
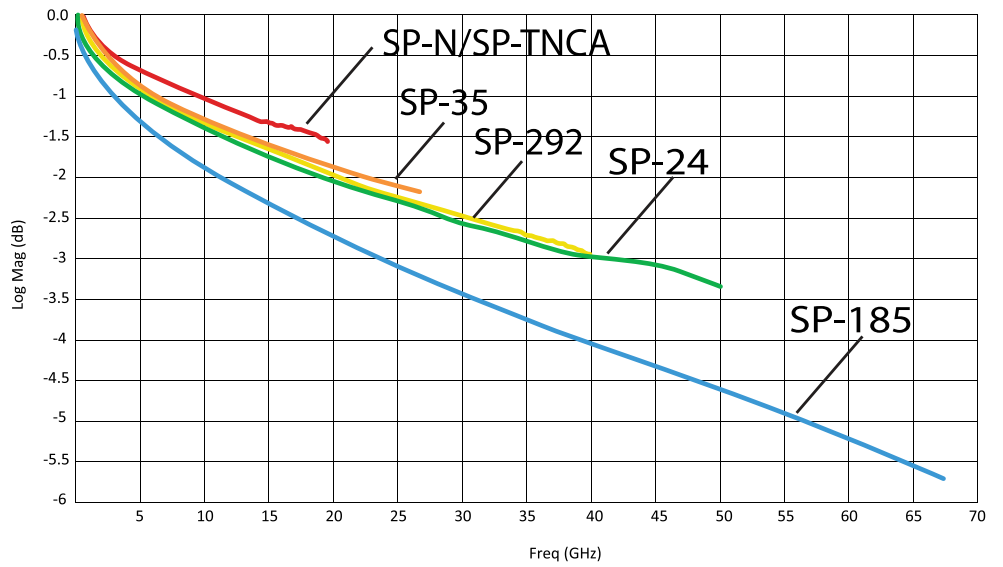

Max Insertion Loss/Attenuation

(1:1 VSWR, 25 C, Sea Level, Cable Only)

| Freq (GHz) | SP-185 (dB/100 ft) | SP-24 (dB/100 ft) | SP-292 (dB/100 ft) | SP-35 (dB/100 ft) | SP-N/SP-TNCA (dB/100 ft) |
|------------|-----------------------|----------------------|-----------------------|----------------------|-----------------------------|
| 1 | 19.00 | 13.3 | 13.3 | 13.3 | 13.3 |
| 2 | 27.00 | 19.00 | 19.00 | 19.00 | 19.00 |
| 4 | 39.00 | 27.20 | 27.00 | 27.52 | 27.52 |
| 6 | 48.00 | 33.20 | 33.20 | 33.20 | 33.20 |
| 8 | 56.00 | 38.40 | 38.40 | 38.40 | 38.40 |
| 12 | 70.00 | 47.40 | 47.40 | 47.40 | 47.40 |
| 18 | 87.00 | 58.50 | 58.50 | 58.50 | 58.50 |
| 26.5 | 108.00 | 71.60 | 71.60 | 71.60 | — |
| 40 | 136.00 | 88.90 | 88.90 | — | — |
| 50 | 155.00 | 100.10 | — | — | — |
| 67 | 183.00 | — | — | — | — |

Average Power Handling

(1:1 VSWR, 25 C, Sea Level, Cable Only)

| Freq (GHz) | SP-185 Watts (Max) | SP-24 Watts (Max) | SP-292 Watts (Max) | SP-35 Watts (Max) | SP-N/SP-TNCA Watts (Max) |
|------------|-----------------------|----------------------|-----------------------|----------------------|-----------------------------|
| 1 | 271 | 409 | 409 | 409 | 409 |
| 2 | 190 | 288 | 288 | 288 | 288 |
| 4 | 132 | 202 | 202 | 202 | 202 |
| 6 | 107 | 165 | 165 | 165 | 165 |
| 8 | 92 | 142 | 142 | 142 | 142 |
| 12 | 74 | 115 | 115 | 115 | 115 |
| 18 | 59 | 93 | 93 | 93 | 93 |
| 26.5 | 48 | 76 | 76 | 76 | — |
| 40 | 38 | 61 | 61 | — | — |
| 50 | 34 | 55 | — | — | — |
| 67 | 28 | — | — | — | — |

StabilityPlus™
Dimensions

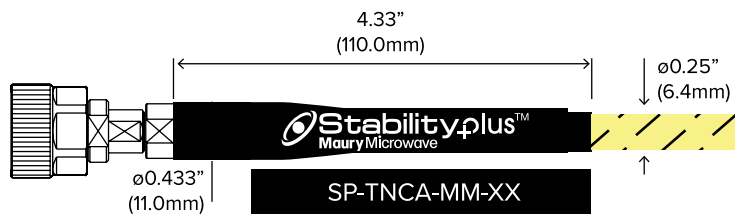
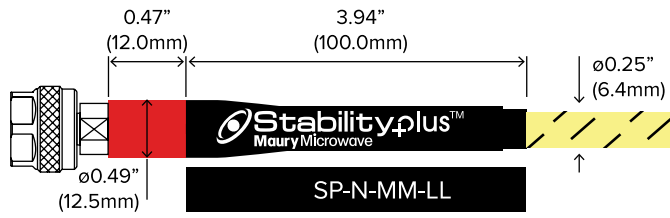
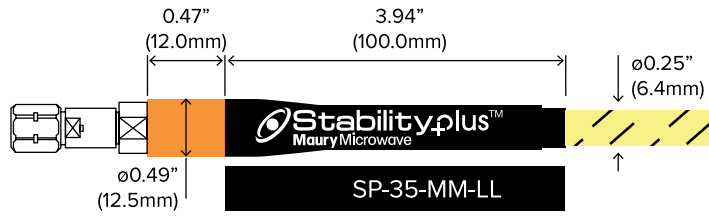
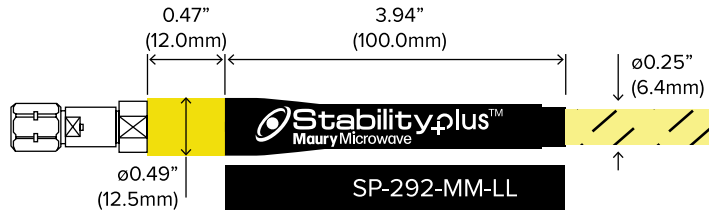
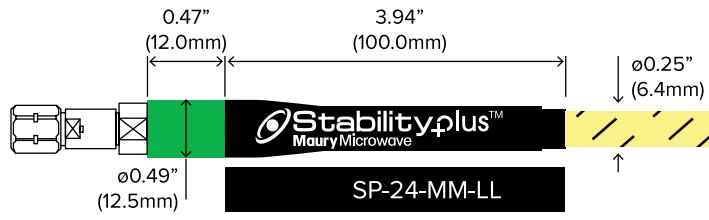
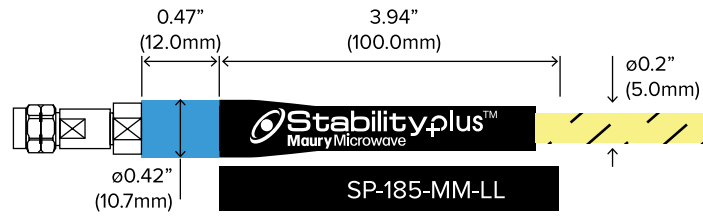

Phase Stability

The maximum value for phase and amplitude stability was established using the following method. The cable was terminated with a short. With the cable in a straight position the VNA was normalized. The cable was then coiled 360° around a mandrel 4 inches in diameter counter-clockwise and held in position for one sweep. The maximum deviation over the frequency range was recorded. The cable was then coiled 360° around the mandrel clockwise and held in position for one sweep and the maximum deviation was recorded. The cable was then returned to its original position for one sweep and the maximum deviation was recorded.

The plots on the right show the recorded worst-case phase variation.

Exemplary data for
SP-185-MM-36

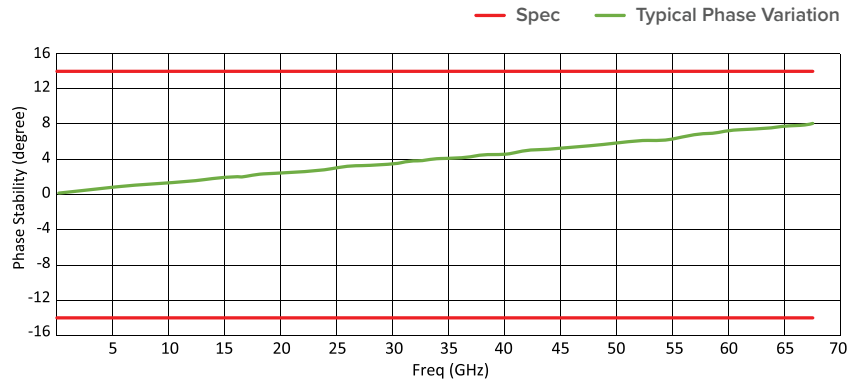

Exemplary data for
SP-24-MM-36

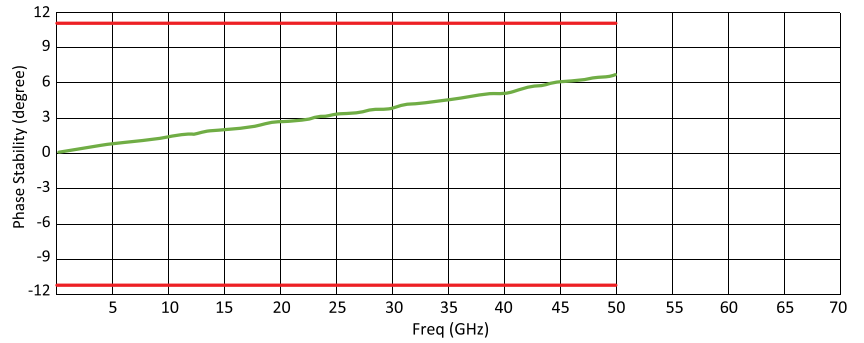

Exemplary data for
SP-292-MM-36

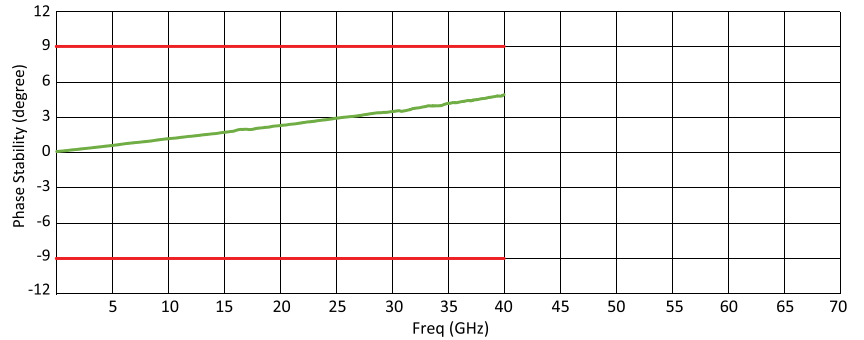

Exemplary data for
SP-35-MM-36

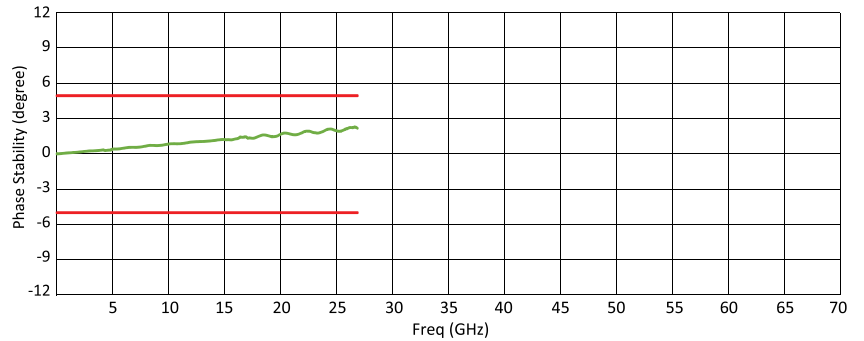

Exemplary data for
SP-N-MM-36/
SP-TNCA-MM-36

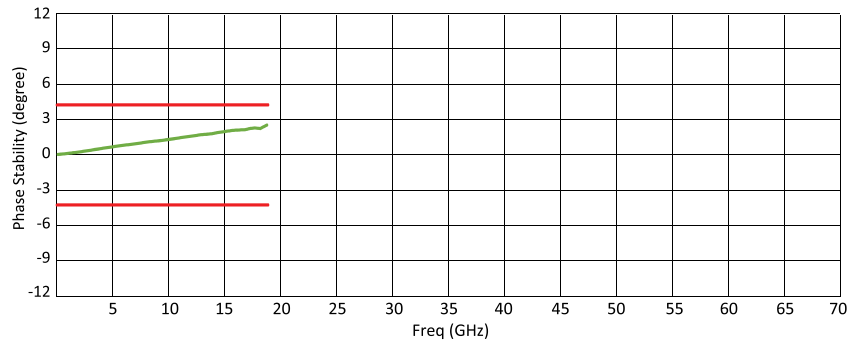

S-parameter measurements with uncertainty

A cable's *phase stability with flexure* specification is a metric used to communicate the impact of cable movement on a DUT measurement. It implies that lower specifications lessen the impact on the measurement (i.e. a cable with a 2° phase stability with flexure specification will have a lesser impact on a measurement than a cable with a 5° phase stability). However, the methods used to determine this specification may not be consistent across manufacturers, and likely do not represent the actual cable movement range of a user.

A better metric to understand a cable's impact on a DUT measurement is "uncertainty contribution". The cable's impact on measurement uncertainty can be calculated by moving the cable through a user's actual range of motion and recording the S-parameters across the movement. This technique has been thoroughly documented by the European Association of National Metrology Institutes (EURAMET)* and has been made commercially available in Maury's Insight™** calibration and measurement software platform.

The plots on the right show typical S-parameter measurements with uncertainty boundaries on different types of DUTs. The boundaries shown only consider the cable's direct contribution on measurement uncertainty.

* <https://www.maurymw.com/pdf/I-CAL-GUI-012.pdf>

** https://www.maurymw.com/Precision/Insight_Software.php

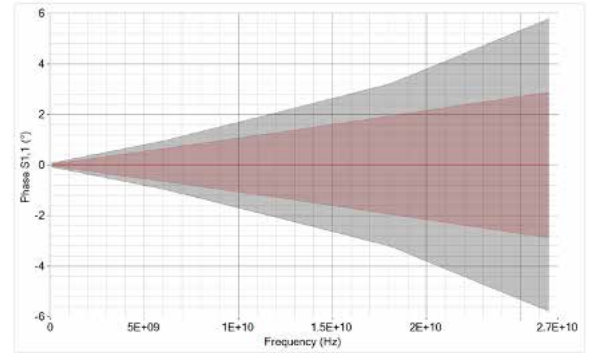

*S11_phase measured on a short circuit termination
SP-35-MM-36 shown in red; leading global
competitor shown in grey*

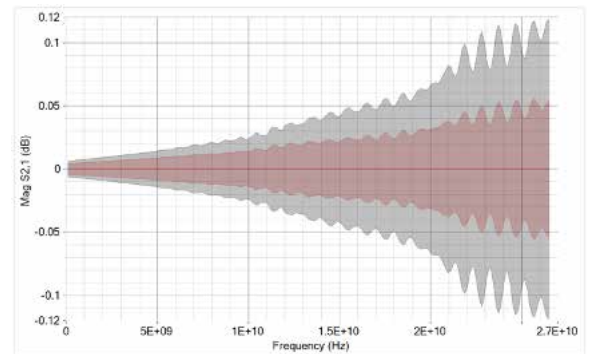

*S21_mag measured on an airline
SP-35-MM-36 shown in red; leading global
competitor shown in grey*

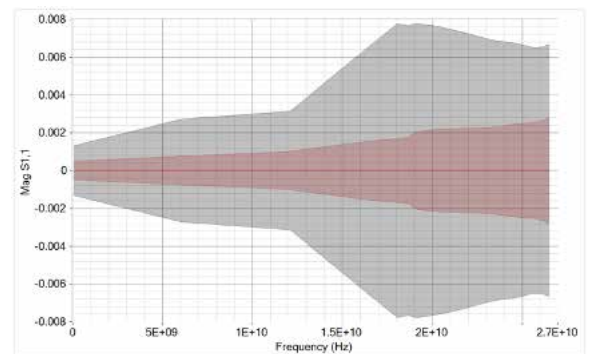

*S11_mag measured on a 50Ω termination
SP-35-MM-36 shown in red; leading global
competitor shown in grey*



Ordering Instructions for StabilityPlus™ Cable Assemblies

Standard StabilityPlus™ Cable Assemblies

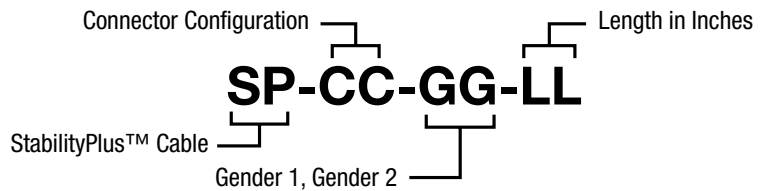

| CC | GG | LL (Standard Lengths) |
|--------------|-----------------------|-----------------------|
| TNCA | | |
| N (Type N)* | | 24 |
| 35 (3.5mm) | MM (Male To Male) | 36 |
| 292 (2.92mm) | MF (Male to Female) | 48 |
| 24 (2.4mm) | FF (Female To Female) | 60 |
| 185 (1.85mm) | | 78 |

* Type N available in male only.

EXAMPLE:

The following is a StabilityPlus™ cable assembly with 3.5mm male connectors on both ends, and 36 inches overall length.

Configuration Sample

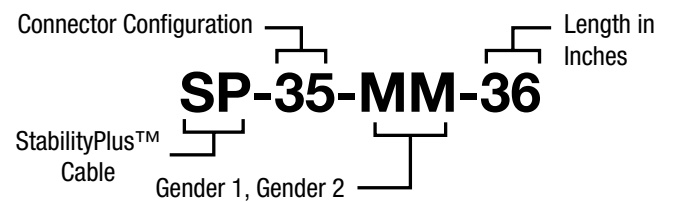

EXAMPLE:

The following is a StabilityPlus™ cable assembly with 2.4mm male connector on one end and 2.92mm male connector on the other end, and 36 inches overall length.

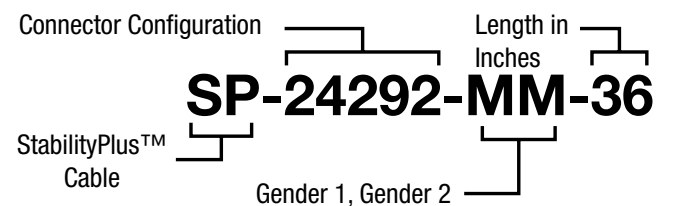

StabilityPlus™ Phase-Matched (PM) Cable Assembly Sets

StabilityPlus™ Phase-Matched Cable Assemblies have been designed for applications where strict phase equality between multiple paths are required. StabilityPlus™ PM Cable Assemblies are matched within $\pm 0.5^\circ/\text{GHz}$ and available as sets of two or more assemblies. StabilityPlus™ PM Cable Assemblies are offered in both standard and low-profile formats and maintain the mechanical and electrical characteristics of the original assembly. Phase-matched assemblies are available with 1.85mm, 2.4mm, 2.92mm, 3.5mm and Type-N connectors and in all lengths.

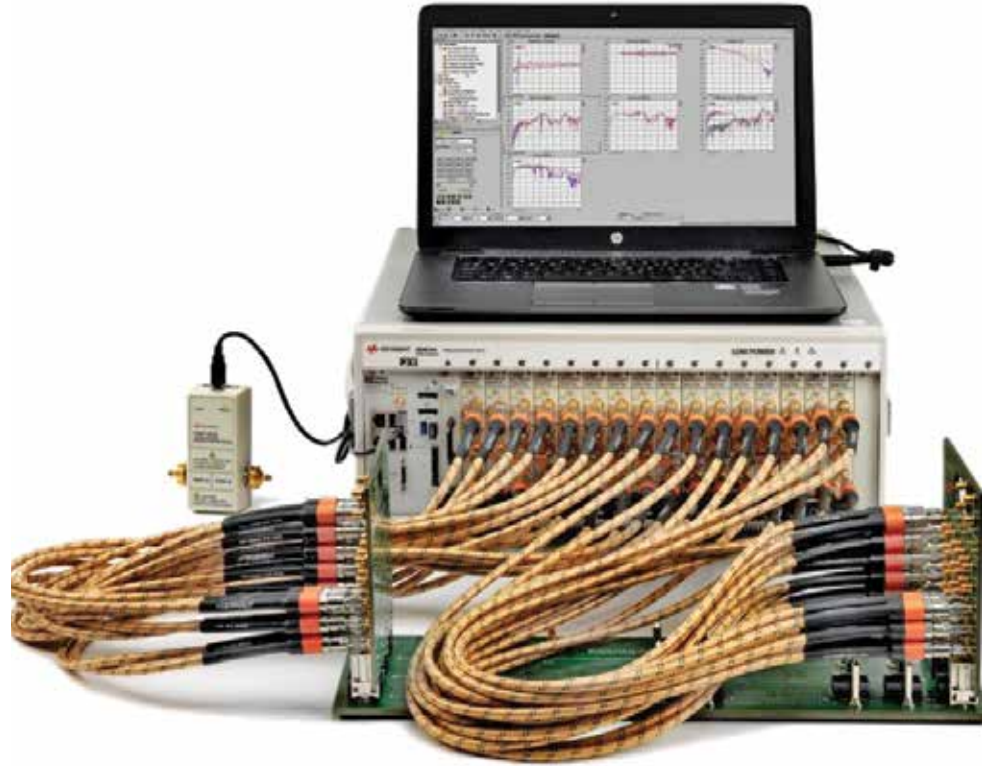

Ordering Instructions for StabilityPlus™ Phase-Matched (PM) Cable Assembly Sets

To specify a StabilityPlus™ Phase-Matched Cable Assembly set, add "PM" at the end of the SP model number, as shown in the example below. "PM" indicates standard configuration Phase-Matched sets.

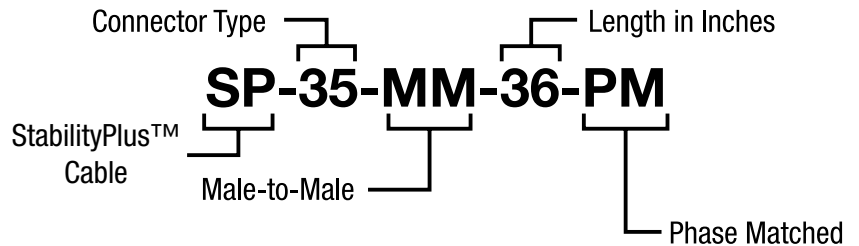

StabilityPlus™ Cable Assemblies — Swept Right-Angle

StabilityPlus™ Cable Assemblies with swept right-angle connectors are designed for applications requiring a fixed and stable bend where traditional cable assemblies may be inconvenient. With a bend radius of 0.5 inches and a cable-to-connector length of 2 inches, right-angle connectors allow StabilityPlus™ Cable Assemblies to retain the electrical and mechanical specifications of the traditional assembly while removing stresses related to hand-formed bends. StabilityPlus™ assemblies with swept right-angle connectors are built on demand and are available with 1.85mm, 2.4mm, 2.92mm, 3.5mm and Type-N connectors.



| CC | G | LL |
|--|--|---------------|
| TNCA N (Type N) 35 (3.5mm) 292 (2.92mm) 24 (2.4mm) 185 (1.85mm) | M (Male) MR (Male swept right-angle) F (Female) FR (Female swept right-angle) | Custom length |

Example:

The following is a StabilityPlus™ cable assembly with one 2.92mm male connector and one 2.4mm male swept right-angle connector, and 24 inches overall length.

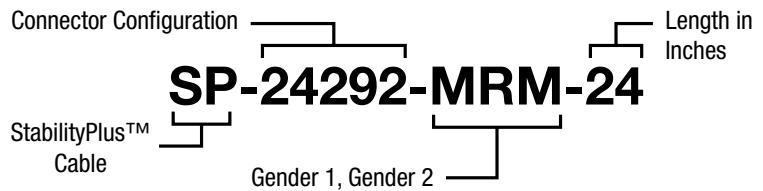

StabilityPlus™ Low-Profile Microwave/RF Cable Assemblies

SERIES SP-185-LP , SP-24-LP, SP-292-LP, AND SP-35-LP

Features and Benefits

- > Stable and repeatable electrical performance
- > Small profile for tight spacing requirements
- > Flexible to facilitate easy installation
- > Lightweight for use with smaller DUTs
- > Color-coded connectors to avoid damage caused by connector mismates

Typical Applications

- > Wafer probing
- > Test bench systems
- > RF and microwave instruments
- > ATE systems
- > Switch matrices
- > R&D and prototyping



Description

Maury Microwave's StabilityPlus™ Low Profile Microwave/RF Cable Assemblies feature the same excellent electrical performance as our ruggedized StabilityPlus™ cables, but with a more compact and flexible design. StabilityPlus™ Low Profile cables provide excellent phase and amplitude stability with flexure resulting in highly reliable, repeatable measurements. They are ideal for applications that require lighter weight or tighter spacing such as wafer probing, ATE systems and switch matrices.

StabilityPlus™ cable assemblies are now part of the ColorConnect™ family! Following the proposed IEEE high-frequency connector/adaptor color convention, StabilityPlus™ cable assemblies are the first commercially available assemblies to offer clear indications of compatibility and intermatability. ColorConnect™ makes it a simple matter to avoid and eliminate damaged equipment, degraded equipment reliability, degraded performance and lengthy maintenance times due to improper mating (and attempted mating) of incompatible interconnects.

Stability™ Specifications

| StabilityPlus™ Low-Profile Cable Type | Frequency | Typical Phase Stability with Flexure | Typical Amplitude Stability with Flexure |
|---------------------------------------|-----------|--------------------------------------|--|
| SP-185-LP | 67 GHz | ±8° | ±0.15 dB |
| SP-24-LP | 50 GHz | ±6° | ±0.05 dB |
| SP-292-LP | 40 GHz | ±4.5° | ±0.05 dB |
| SP-35-LP | 26.5 GHz | ±3° | ±0.05 dB |



DATA SHEET
2Z-010

Standard Cable Assembly Specifications

| StabilityPlus™ Low-Profile Cable Type | SP-185 LP | SP-24 LP | SP-292 LP | SP-35 LP |
|--|------------------------|---------------|------------|------------|
| Maximum Frequency | 67 GHz | 50 GHz | 40 GHz | 26.5 GHz |
| VSWR (typical) | 1.40:1 | 1.30:1 | 1.25:1 | |
| Typical Insertion Loss (cable only) | 1.79 dB/ft | 1.00 dB/ft | 0.89 dB/ft | 0.72 dB/ft |
| Phase Stability vs Flexure (typical) | ±8° | ± 6° | ± 4.5° | ± 3° |
| Phase Stability vs Flexure (maximum) | ±14° | ± 10.5° | ± 8.5° | ± 5.5° |
| Amplitude Stability vs Flexure (typical) | ±0.15 dB | ± 0.05 dB | | |
| Amplitude Stability vs Flexure (maximum) | ±0.20 dB | ± 0.10 dB | | |
| Phase Stability vs Temp | <4°/m/GHz (-55°+105°C) | | | |
| Impedance (nominal) | 50 ohm | | | |
| Velocity of Propagation | 74% (nominal) | 76% (nominal) | | |
| Shielding Effectiveness | >90 dB (DC - 18 GHz) | | | |
| Time Delay (nominal) | 1.34 ns/ft (4.5 ns/m) | | | |

Mechanical / Environmental Properties

| StabilityPlus™ Low-Profile Cable Type | SP-185-LP | SP-24-LP, SP-292-LP & SP-35-LP |
|--|---------------------------------|--------------------------------|
| Center Conductor Material | Silver Plated Copper | |
| Maximum Outer Diameter (Connector) | 0.37 in (9.5mm) | 0.38 in (9.6mm) |
| Maximum Outer Diameter (Cable) | 0.1 in (2.6mm) | 0.14 in (3.6mm) |
| Nominal Weight | 0.237 oz/ft (22g/m) | 0.38 oz/ft (35g/m) |
| Min. Static Bend Radius/ Min. Dynamic Bend Radius | 0.51 in (13mm)/1.1 in (28mm) | 0.55 in (14mm)/1.4 in (36mm) |
| Flex Life Cycles | >15,000 | |
| Connector Mating Cycles | >5,000 | |
| Crush Resistance | >23 lbf/in (4 kgf/cm) | |
| Operating Temperature Range | -67°F to 221°F (-55°C to 105°C) | |
| RoHS/REACH | Yes | |

**Maury StabilityPlus™ Cable
Assembly Typical Performance**

*Maury StabilityPlus™
36" Cable Assembly
Typical VSWR*

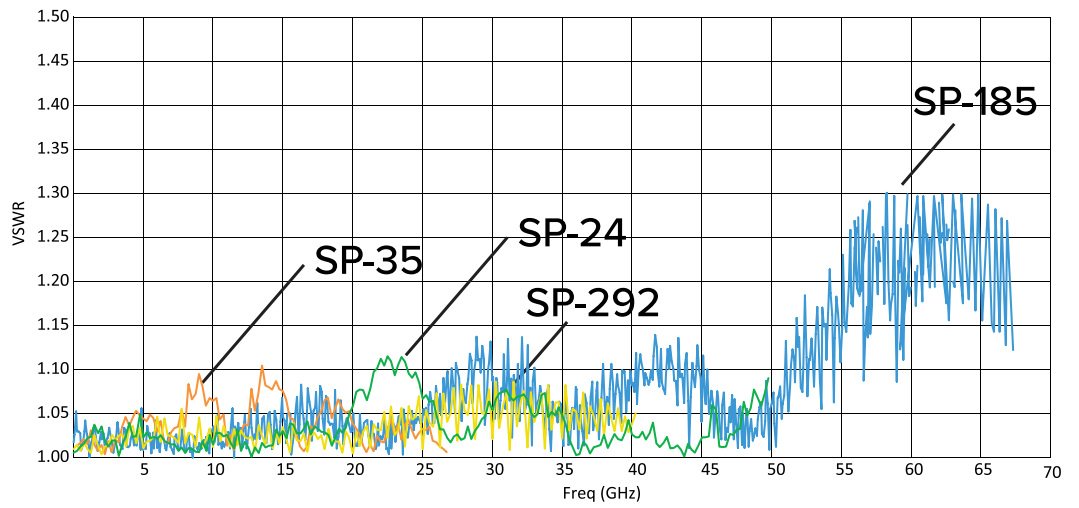

*Maury StabilityPlus™ 36"
Cable Assembly Typical
Insertion Loss*

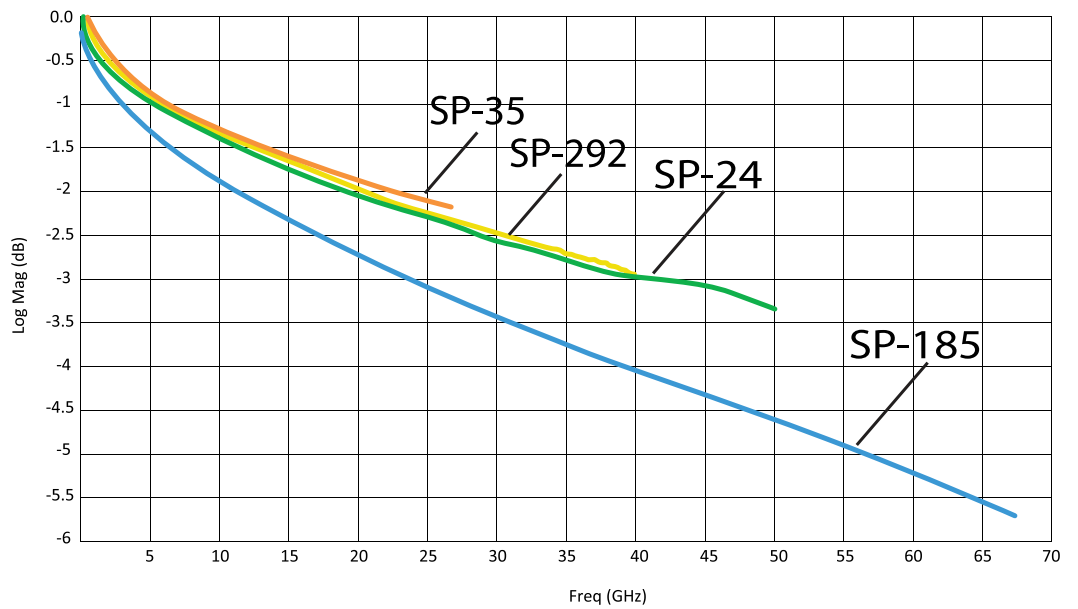

Max Insertion Loss/Attenuation

(1:1 VSWR, 25 C, Sea Level, Cable Only)

| Freq (GHz) | SP-185-LP (dB/100 ft) | SP-24-LP (dB/100 ft) | SP-292-LP (dB/100 ft) | SP-35-LP (dB/100 ft) |
|------------|--------------------------|-------------------------|--------------------------|-------------------------|
| 1 | 19.00 | 13.3 | 13.3 | 13.3 |
| 2 | 27.00 | 19.00 | 19.00 | 19.00 |
| 4 | 39.00 | 27.20 | 27.00 | 27.52 |
| 6 | 48.00 | 33.20 | 33.20 | 33.20 |
| 8 | 56.00 | 38.40 | 38.40 | 38.40 |
| 12 | 70.00 | 47.40 | 47.40 | 47.40 |
| 18 | 87.00 | 58.50 | 58.50 | 58.50 |
| 26.5 | 108.00 | 71.60 | 71.60 | 71.60 |
| 40 | 136.00 | 88.90 | 88.90 | — |
| 50 | 155.00 | 100.10 | — | — |
| 67 | 183.00 | — | — | — |

Average Power Handling

(1:1 VSWR, 25 C, Sea Level, Cable Only)

| Freq (GHz) | SP-185-LP Watts (Max) | SP-24-LP Watts (Max) | SP-292-LP Watts (Max) | SP-35-LP Watts (Max) |
|------------|--------------------------|-------------------------|--------------------------|-------------------------|
| 1 | 271 | 409 | 409 | 409 |
| 2 | 190 | 288 | 288 | 288 |
| 4 | 132 | 202 | 202 | 202 |
| 6 | 107 | 165 | 165 | 165 |
| 8 | 92 | 142 | 142 | 142 |
| 12 | 74 | 115 | 115 | 115 |
| 18 | 59 | 93 | 93 | 93 |
| 26.5 | 48 | 76 | 76 | 76 |
| 40 | 38 | 61 | 61 | — |
| 50 | 34 | 55 | — | — |
| 67 | 28 | — | — | — |

**StabilityPlus™ Low
Profile Dimensions**

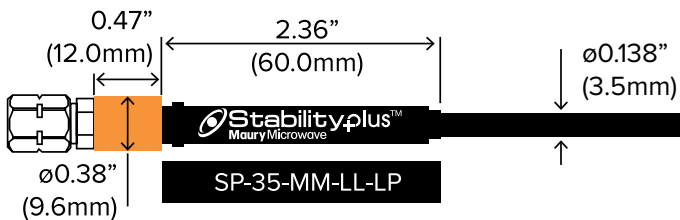
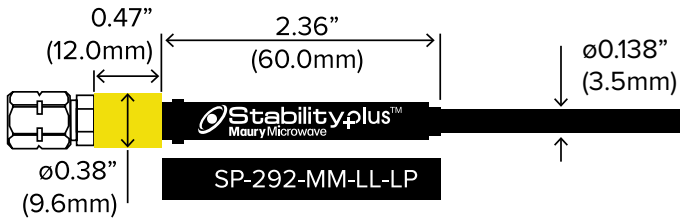
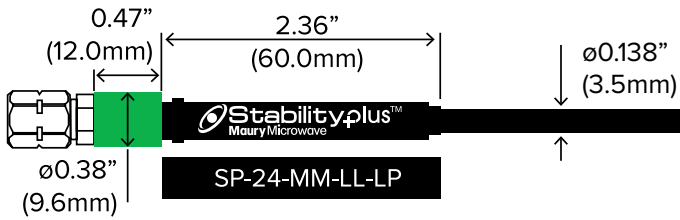
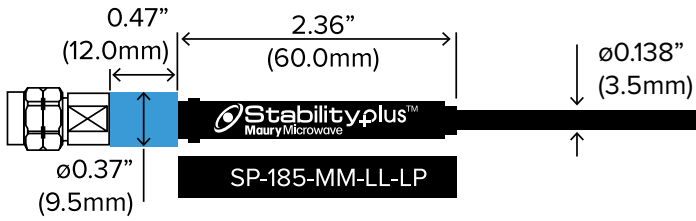

Phase Stability

The maximum value for phase and amplitude stability was established using the following method. The cable was terminated with a short. With the cable in a straight position the VNA was normalized. The cable was then coiled 360° around a mandrel 4 inches in diameter counter-clockwise and held in position for one sweep. The maximum deviation over the frequency range was recorded. The cable was then coiled 360° around the mandrel clockwise and held in position for one sweep and the maximum deviation was recorded. The cable was then returned to its original position for one sweep and the maximum deviation was recorded.

The plots on the right show the recorded worst-case phase variation.

Exemplary data for
SP-185-MM-36

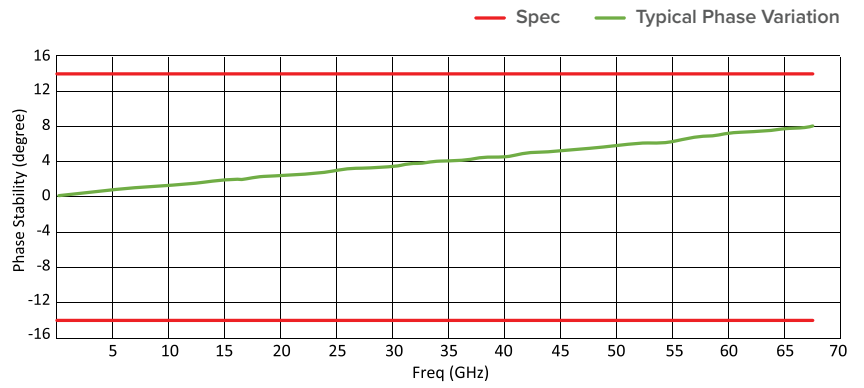

Exemplary data for
SP-24-MM-36

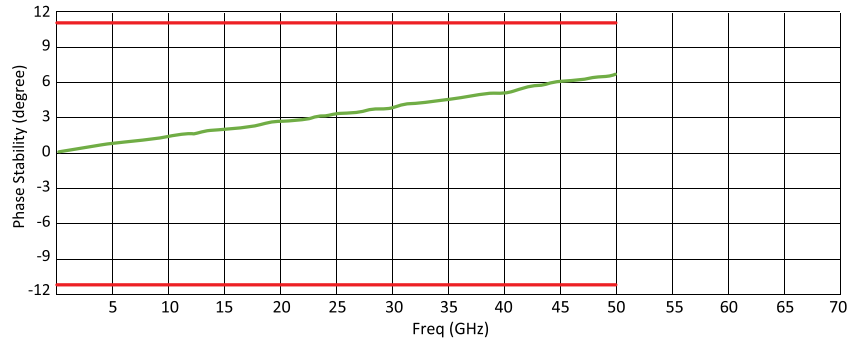

Exemplary data for
SP-292-MM-36

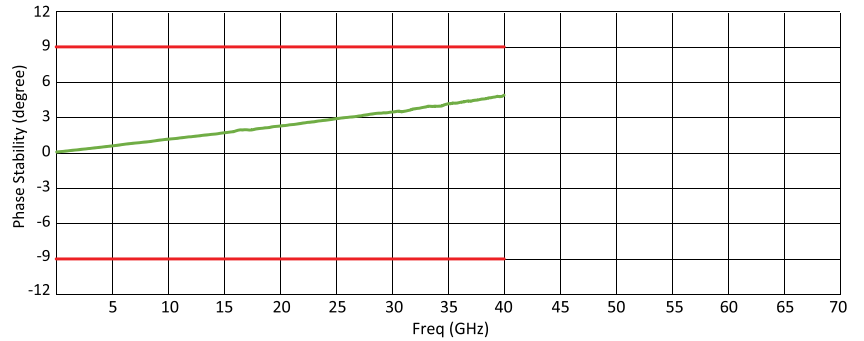

Exemplary data for
SP-35-MM-36

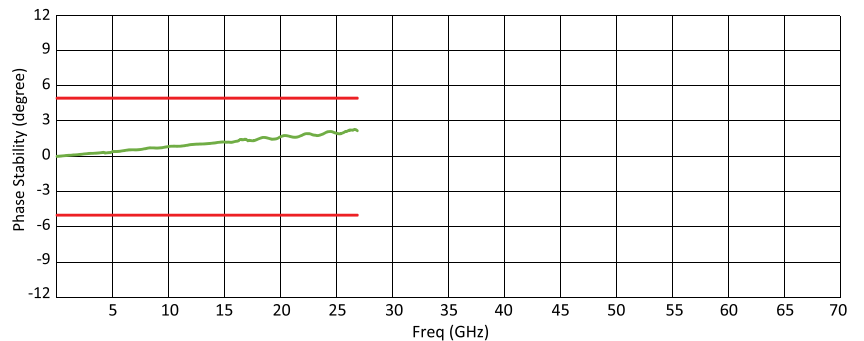

S-parameter measurements with uncertainty

A cable's *phase stability with flexure* specification is a metric used to communicate the impact of cable movement on a DUT measurement. It implies that lower specifications lessen the impact on the measurement (i.e. a cable with a 2° phase stability with flexure specification will have a lesser impact on a measurement than a cable with a 5° phase stability). However, the methods used to determine this specification may not be consistent across manufacturers, and likely do not represent the actual cable movement range of a user.

A better metric to understand a cable's impact on a DUT measurement is "uncertainty contribution". The cable's impact on measurement uncertainty can be calculated by moving the cable through a user's actual range of motion and recording the S-parameters across the movement. This technique has been thoroughly documented by the European Association of National Metrology Institutes (EURAMET)* and has been made commercially available in Maury's Insight™** calibration and measurement software platform.

The plots on the right show typical S-parameter measurements with uncertainty boundaries on different types of DUTs. The boundaries shown only consider the cable's direct contribution on measurement uncertainty.

* <https://www.maurymw.com/pdf/I-CAL-GUI-012.pdf>

** https://www.maurymw.com/Precision/Insight_Software.php

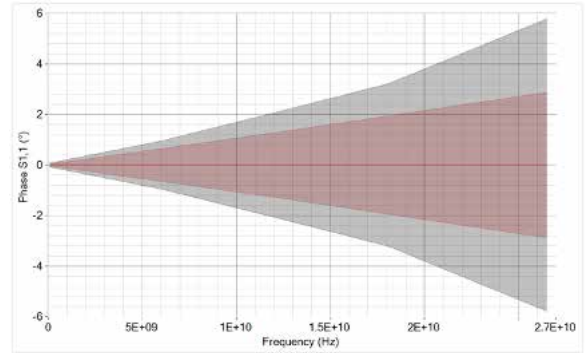

*S11_phase measured on a short circuit termination
SP-35-MM-36-LP shown in red; leading global
competitor shown in grey*

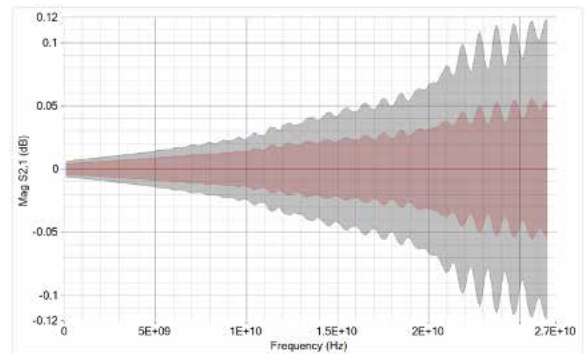

*S21_mag measured on an airline
SP-35-MM-36-LP shown in red; leading global
competitor shown in grey*

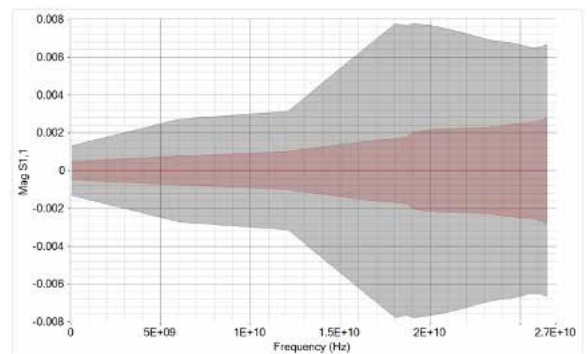

*S11_mag measured on a 50Ω termination
SP-35-MM-36-LP shown in red; leading global
competitor shown in grey*



Ordering Instructions for StabilityPlus™ Low-Profile Cable Assemblies

Standard StabilityPlus™ Low-Profile Cable Assemblies

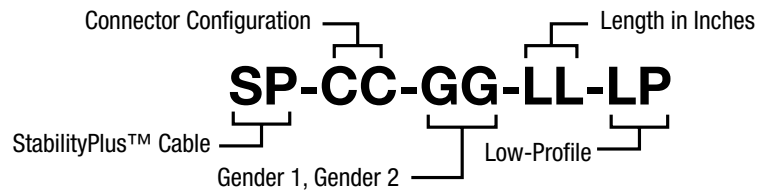

| CC | GG | LL (Standard Lengths) | Low-Profile |
|--------------|---|-----------------------|------------------|
| 35 (3.5mm) | MM (Male To Male) MF (Male to Female) FF (Female To Female) | 24 | LP (Low-Profile) |
| 292 (2.92mm) | | 36 | |
| 24 (2.4mm) | | 48 | |
| 185 (1.85mm) | | 60 | |
| | | 78 | |

EXAMPLE:

The following is a StabilityPlus™ Low-Profile cable assembly with 2.4mm male connector on one end and 2.92mm male connector on the other end, and 36 inches overall length.

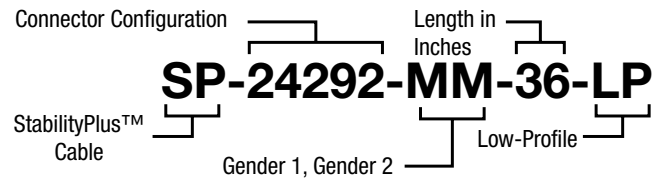

EXAMPLE:

The following is a StabilityPlus™ Low Profile cable assembly with 2.92mm male connector on one end and female connector on the other end, and 48 inches overall length.

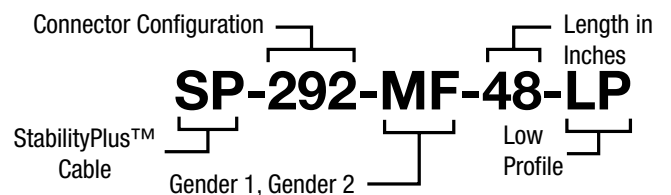

StabilityPlus™ Phase-Matched (PM) Cable Assembly Sets

StabilityPlus™ Phase-Matched Cable Assemblies have been designed for applications where strict phase equality between multiple paths are required. StabilityPlus™ PM Cable Assemblies are matched within $\pm 0.5^\circ/\text{GHz}$ and available as sets of two or more assemblies. StabilityPlus™ PM Cable Assemblies are offered in both standard and low-profile formats and maintain the mechanical and electrical characteristics of the original assembly. Phase-matched assemblies are available with 1.85mm, 2.4mm, 2.92mm, 3.5mm and Type-N connectors and in all lengths.

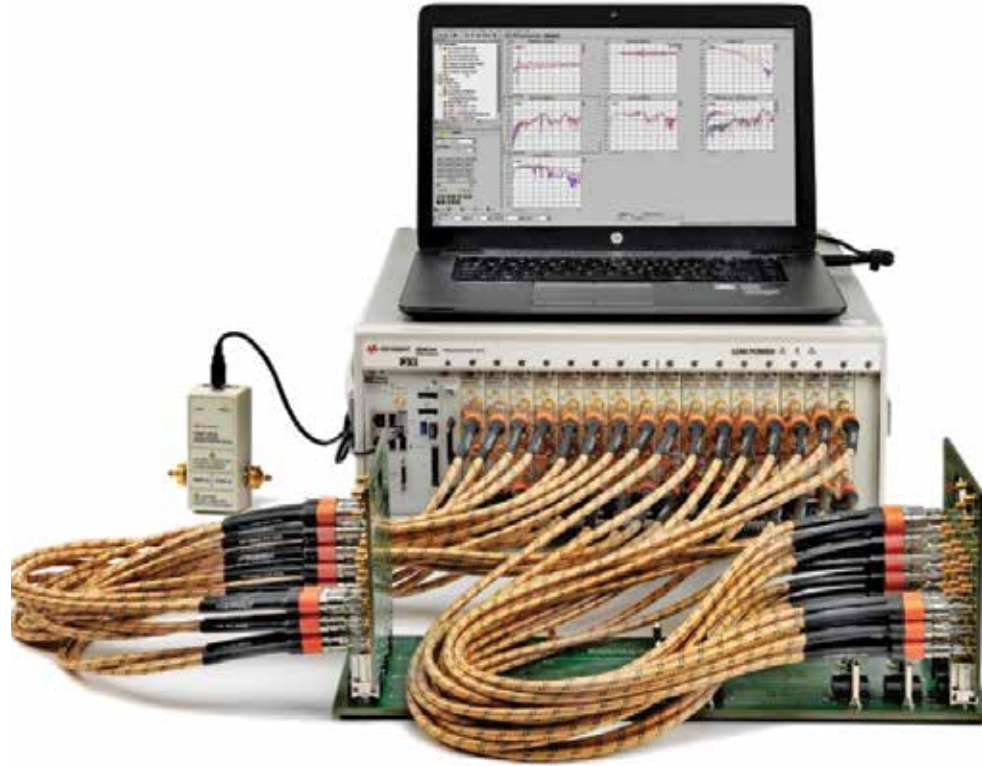

Ordering Instructions for StabilityPlus™ Phase-Matched (PM) Cable Assembly Sets

To specify a StabilityPlus™ Phase-Matched Cable Assembly set, add "PM" or "LPPM" at the end of the SP model number, as shown in the example below. "PM" indicates standard configuration Phase-Matched sets; "LPPM" indicates Low Profile configuration, Phase-Matched sets.

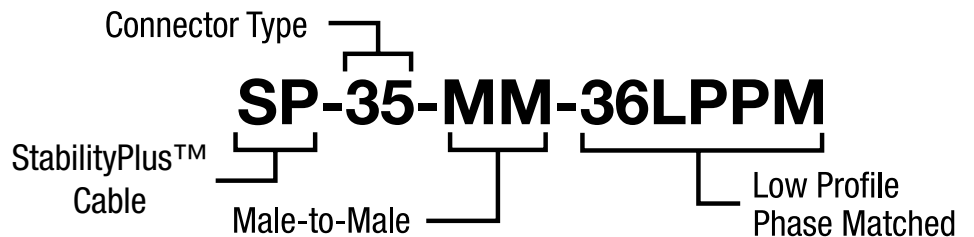

**StabilityPlus™
Low-Profile Cable
Assemblies —
Swept Right-Angle**

StabilityPlus™ Low-Profile Cable Assemblies with swept right-angle connectors are designed for applications requiring a fixed and stable bend where traditional cable assemblies may be inconvenient. With a bend radius of 0.5 inches and a cable-to-connector length of 2 inches, right-angle connectors allow StabilityPlus™ Low-Profile Cable Assemblies to retain the electrical and mechanical specifications of the traditional assembly while removing stresses related to hand-formed bends. StabilityPlus™ Low-Profile assemblies with swept right-angle connectors are built on demand and are available with 1.85mm, 2.4mm, 2.92mm, 3.5mm and Type-N connectors.

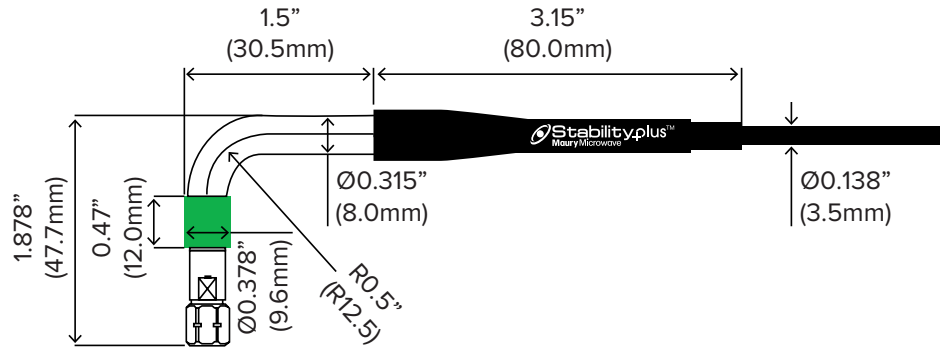

| CC | G | LL |
|--|--|---------------|
| 35 (3.5mm) 292 (2.92mm) 24 (2.4mm) 185 (1.85mm) | M (Male) MR (Male swept right-angle) F (Female) FR (Female swept right-angle) | Custom length |

Example:

The following is a StabilityPlus™ Low-Profile cable assembly with one 2.92mm male connector and one 2.4mm male swept right-angle connector, and 36 inches overall length.

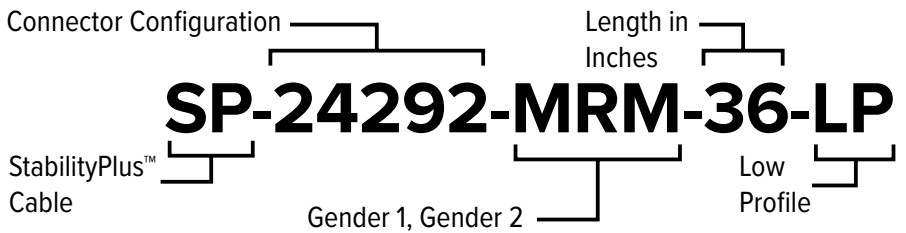

StabilityBench™ Microwave/RF Cable Assemblies

SERIES SB-N AND SB-SMA

Features and Benefits

- > Excellent value
- > Low insertion loss
- > Reliable and repeatable measurements
- > Amplitude and phase stable with flexure
- > High mating-cycle durability

Typical Applications

- > RF and microwave instruments
- > Bench-top testing
- > Probe station integrations
- > RF production testing
- > Component/module testing
- > ATE systems



Description

Maury Microwave's StabilityBench™ series sets the standard for high-end all-purpose test and measurement cable assemblies. Designed for general testing applications, StabilityBench™ offers excellent value with its low cost, low insertion loss, excellent return loss, flexibility, and amplitude and phase stability. StabilityBench™ is the ideal interconnection for reliable and

repeatable measurements when mated with test instruments including bench-top testing, on-wafer characterization and ATE systems.

StabilityBench™ cable assemblies are now part of the ColorConnect™ family! Following the proposed IEEE high-frequency connector/adaptor color convention, StabilityBench™ cable assemblies are the first commercially

available assemblies to offer clear indications of compatibility and intermatability. ColorConnect™ makes it a simple matter to avoid and eliminate damaged equipment, degraded equipment reliability, degraded performance and lengthy maintenance times due to improper mating (and attempted mating) of incompatible interconnects.

Cable Assembly Specifications

Electrical Properties

| StabilityBench™ Cable Type | Type N | SMA |
|--|------------------------|------------|
| Maximum Freq. | 18 GHz | 26.5 GHz |
| VSWR (typical) | 1.25 | |
| Typical IL (cable only) | 0.68 dB/ft | 0.88 dB/ft |
| Impedance (nominal) | 50 ohm | |
| Phase Stability vs Flexure (typical) | ±3° | ±4° |
| Amplitude Stability vs Flexure (typical) | ±0.05 dB | |
| Velocity of Propagation | 70% | |
| Shielding Effectiveness | 100 dB | |
| Time Delay (nominal) | 1.45 ns/ft (4.76 ns/m) | |

Mechanical/Environmental Properties

| StabilityBench™ Cable Type | Type N | SMA |
|--|---------------------------------|-------------------|
| Center Conductor Material | Silver Plated Copper Clad Steel | |
| Maximum Outer Diameter (Connector) | 0.87 in (22.1 mm) | 0.50 in (12.8 mm) |
| Maximum Outer Diameter (Cable) | 0.193 in (4.9 mm) | 0.193 in (4.9 mm) |
| Nominal Weight | 0.69 oz/ft (64 g/m) | |
| Min. Static Bend Radius/ Min. Dynamic Bend Radius | 2.0 in (50.8 mm) | |
| Min. Dynamic Bend Radius | 2.0 in (50.8 mm) | |
| Flex Life Cycles | >10,000 | |
| Crush Resistance | >134 lbf/in (23 kgf/cm) | |
| Operating Temperature Range | -67°+157 °F (-55°+105°C) | |
| RoHS/REACH | Yes | |

Anatomy of StabilityBench™ Microwave/RF Cable Assemblies

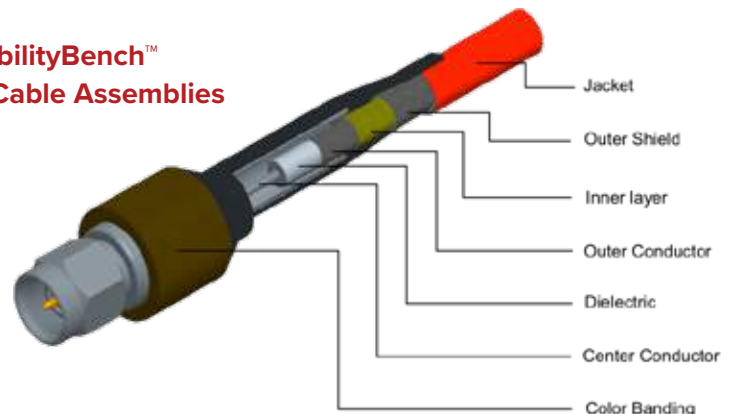

DATA SHEET
2Z-007

Maury StabilityBench™ Cable Assembly Typical Performance

Maury StabilityBench™ 36" Cable Assembly Typical VSWR

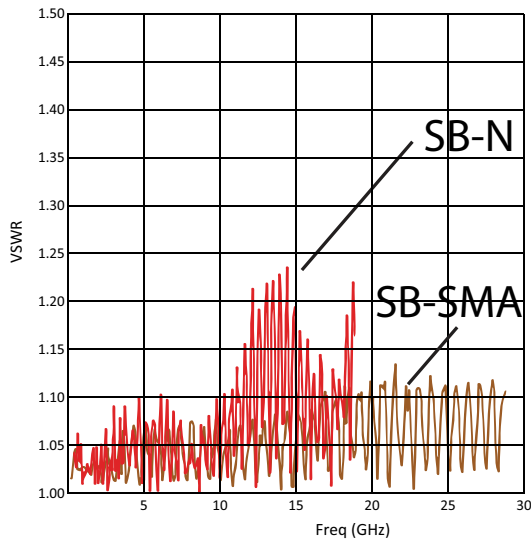

Maury StabilityBench™ 36" Cable Assembly Typical Insertion Loss

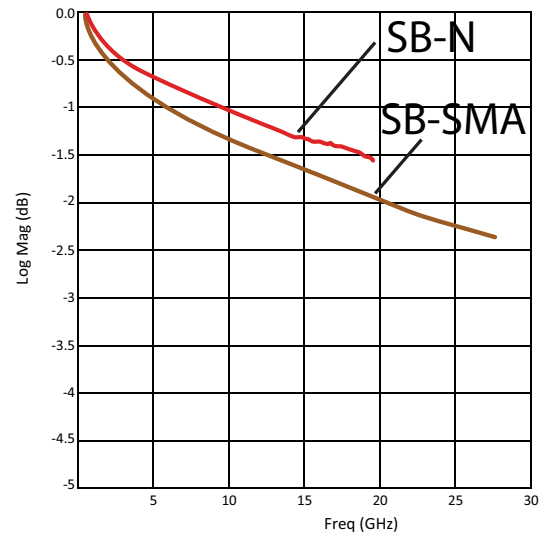

| CC | GG | LL (Standard Lengths) |
|--------------------|---|----------------------------|
| N (Type N)* SMA | MM (Male To Male) MF (Male to Female) FF (Female To Female) | 24 36 48 60 72 |

* Type N available in male only.

Ordering Instructions for StabilityBench™ Cable Assemblies

Standard StabilityBench™ Cable Assemblies

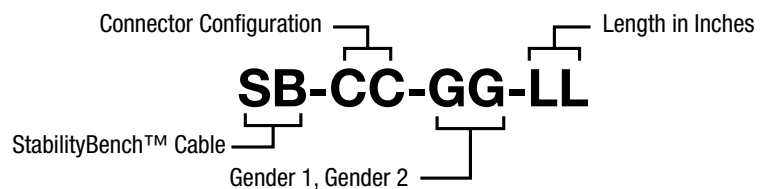

EXAMPLE:

The following is a StabilityBench™ cable assembly with Type N male connectors on both ends, and 36 inches overall length.

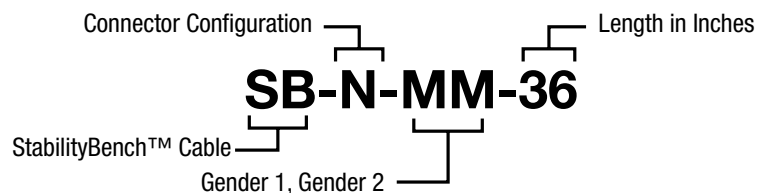

EXAMPLE:

The following is a StabilityBench™ cable assembly with SMA male connector on one end and Type N connector on the other end, and 36 inches overall length.

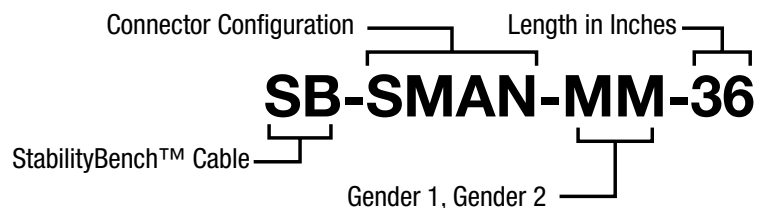

S-parameter measurements with uncertainty

A cable's *phase stability with flexure* specification is a metric used to communicate the impact of cable movement on a DUT measurement. It implies that lower specifications lessen the impact on the measurement (i.e. a cable with a 2° phase stability with flexure specification will have a lesser impact on a measurement than a cable with a 5° phase stability). However, the methods used to determine this specification may not be consistent across manufacturers, and likely do not represent the actual cable movement range of a user.

A better metric to understand a cable's impact on a DUT measurement is "uncertainty contribution". The cable's impact on measurement uncertainty can be calculated by moving the cable through a user's actual range of motion and recording the S-parameters across the movement. This technique has been thoroughly documented by the European Association of National Metrology Institutes (EURAMET)* and has been made commercially available in Maury's Insight™** calibration and measurement software platform.

The plots on the right show typical S-parameter measurements with uncertainty boundaries on different types of DUTs. The boundaries shown only consider the cable's direct contribution on measurement uncertainty.

* <https://www.maurymw.com/pdf/I-CAL-GUI-012.pdf>

** https://www.maurymw.com/Precision/Insight_Software.php

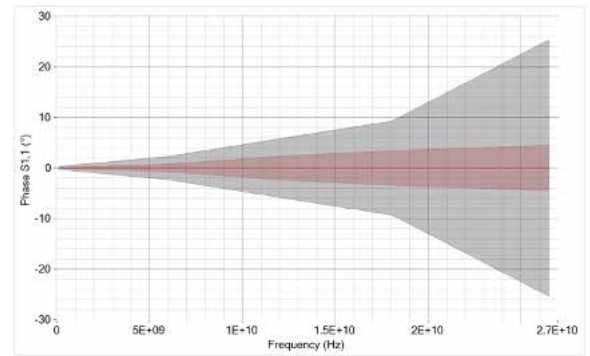

*S11_phase measured on a short circuit termination
SB-SMA-MM-36 shown in red; leading global
competitor shown in grey*

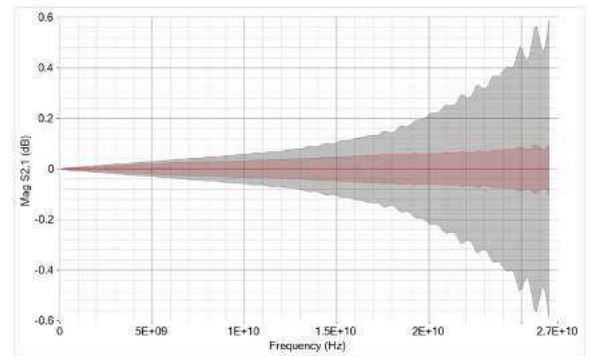

*S21_mag measured on a short circuit termination
SB-SMA-MM-36 shown in red; leading global
competitor shown in grey*

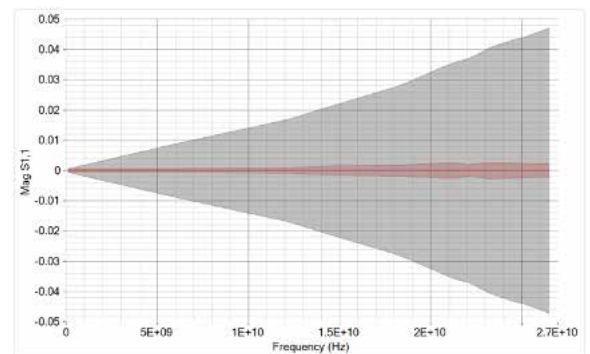

*S11_mag measured on a short circuit termination
SB-SMA-MM-36 shown in red; leading global
competitor shown in grey*



StabilityTVAC™ Cable Assemblies

Features and Benefits

- > Low outgassing
- > Vented connectors
- > Thermally conditioned
- > Phase stable with flexure
- > High power handling
- > Low insertion loss

Typical Applications

- > TVAC test chambers

Description

Thermal Vacuum (TVAC) chambers are used by space component manufacturers to test components, sub-systems and even entire satellites under space-like conditions. It is essential that the T&M components, including cable assemblies, used to test the device-under-test (DUT) inside the chamber be specifically designed to accommodate the effects of pressure and temperature created within the TVAC chamber.

Outgassing is the process whereby varying temperature and vacuum conditions cause materials to release free volatiles, which can deposit on other components in a test system and cause significant contamination. StabilityTVAC™ assemblies use low outgassing materials which meet the requirements of ASTM E-595 with a TML < 1% and CVCM < 0.1%.

Changes in vacuum conditions force air in and out of cable assemblies, which can cause damage if not properly accounted for. Standard connectors require a slower change in pressure or risk damage. StabilityTVAC™ uses vented connectors which allow air to escape much faster, thereby empowering cable assemblies to stabilize and be used with minimal delays, and tests to be performed using rapid pressurization/depressurization cycles.

Like most mechanical components, cable assemblies expand and contract when presented with varying temperatures, which can cause changes in performance and even a permanent degradation. StabilityTVAC™ cable assemblies are thermally conditioned, going through aging and stabilization to relieve mechanical stresses for reliable performance over temperature.



DATA SHEET
2Z-012

Standard Cable Assembly Specifications

| StabilityTVAC™ Cable Type | TV-292 | TV-292-LP | TV-SMA | TV-SMA-LP |
|--|------------------------|-----------|-------------|-----------|
| Maximum Frequency | 40 GHz | | 26.5 GHz | |
| VSWR (typical) | 1.25 | | | |
| VSWR (maximum) | 1.30 | | | |
| Typical Insertion Loss (cable only) | 0.672 dB/ft | | 0.537 dB/ft | |
| Impedance (nominal) | 50 ohm | | | |
| Phase Stability vs Flexure (typical) | ±4.5° | | ±2° | |
| Amplitude Stability vs Flexure (typical) | ±0.05 dB | | | |
| Phase Stability vs Temp | ≤600PPM | | | |
| Velocity of Propagation | 82% (nominal) | | | |
| Shielding Effectiveness | > 90 dB (DC - 18 GHz) | | | |
| Time Delay (nominal) | 1.24 ns/ft (4.07 ns/m) | | | |
| Dielectric Withstanding Voltage | 750V | | | |

Mechanical / Environmental Properties

| StabilityTVAC™ Cable Type | TV-292 | TV-292-LP | TV-SMA | TV-SMA-LP |
|--|---------------------------------|------------------------|------------------------|------------------------|
| Center Conductor Material | Silver Plated Copper | | | |
| Maximum Outer Diameter (Connector) | 0.35 in (9mm) | 0.35 in (9mm) | 0.35 in (9mm) | 0.35 in (9mm) |
| Maximum Outer Diameter (Cable) | 0.256 in (6.5mm) | 0.15 in (3.8mm) | 0.256 in (6.5mm) | 0.15 in (3.8mm) |
| Nominal Weight (Cable) | .34 oz/ft (32 g/m) | | | |
| Min. Static Bend Radius (Inch) / Min. Dynamic Bend Radius (Inch) | 1.283 in / 2.56 in | 0.748 in / 1.5 in | 1.283 in / 2.56 in | 0.748 in / 1.5 in |
| Flex Life Cycles | >500 | | | |
| Crush Resistance | 250 lbf/in (44 kgf/cm) | 27 lbf/in (4.8 kgf/cm) | 250 lbf/in (44 kgf/cm) | 27 lbf/in (4.8 kgf/cm) |
| Operating Temperature Range | -67°F to 329°F (-55°C to 165°C) | | | |
| RoHS/REACH | Yes | | | |
| Outgassing | TML<1%, CVCM< 0.1% | | | |

Max Insertion Loss/Attenuation

| Freq (GHz) | TV-292 (db/100 ft) | TV-292-LP (db/100 ft) | TV-SMA (db/100 ft) | TV-SMA-LP (db/100 ft) |
|------------|--------------------|-----------------------|--------------------|-----------------------|
| 0.5 | 6.8 | | 6.8 | |
| 1 | 9.7 | | 9.7 | |
| 1.5 | 12 | | 12 | |
| 2 | 13.9 | | 13.9 | |
| 3 | 17.1 | | 17.1 | |
| 4 | 19.8 | | 19.8 | |
| 5 | 22.2 | | 22.2 | |
| 6 | 24.4 | | 24.4 | |
| 8 | 28.4 | | 28.4 | |
| 10 | 31.9 | | 31.9 | |
| 12 | 35.1 | | 35.1 | |
| 12.4 | 35.8 | | 35.8 | |
| 13.5 | 37.4 | | 37.4 | |
| 15 | 39.6 | | 39.6 | |
| 18 | 43.6 | | 43.6 | |
| 24 | 50.9 | | 50.9 | |
| 26.5 | 53.7 | | 53.7 | |
| 40 | 67.2 | | - | |

Average Power Handling

| Freq (GHz) | TV-292 Watts (Max) | TV-292-LP Watts (Max) | TV-SMA Watts (Max) | TV-SMA-LP Watts (Max) |
|------------|--------------------|-----------------------|--------------------|-----------------------|
| 0.5 | 726 | | 726 | |
| 1 | 511 | | 511 | |
| 1.5 | 415 | | 415 | |
| 2 | 359 | | 359 | |
| 3 | 291 | | 291 | |
| 4 | 251 | | 251 | |
| 5 | 224 | | 224 | |
| 6 | 203 | | 203 | |
| 8 | 175 | | 175 | |
| 10 | 156 | | 156 | |
| 12 | 141 | | 141 | |
| 12.4 | 139 | | 139 | |
| 13.5 | 133 | | 133 | |
| 15 | 126 | | 126 | |
| 18 | 114 | | 114 | |
| 24 | 98 | | 98 | |
| 26.5 | 93 | | 93 | |
| 40 | 74 | | - | |

Low-Loss Cable Assembly Specifications

| StabilityTVAC™ Cable Type | TV-N-LL | TV-N-LL-LP | TV-SMA-LL | TV-SMA-LL-LP | TV-TNC-LL | TV-TNC-LL-LP |
|--|------------------------|------------|-----------|--------------|-------------------------|--------------|
| Maximum Frequency | 18 GHz | | | | 12.4 GHz | |
| VSWR (typical) | 1.25 | | | | | |
| VSWR (maximum) | 1.30 | | | | | |
| Typical Insertion Loss (cable only) | 0.205 dB/ft | | | | 0.167 dB/ft | |
| Impedance (nominal) | 50 ohm | | | | | |
| Phase Stability vs Flexure (typical) | ±2° | | | | | |
| Amplitude Stability vs Flexure (typical) | ±0.05 dB | | | | | |
| Phase Stability vs Temp | ≤600PPM | | | | | |
| Velocity of Propagation | 82% (nominal) | | | | | |
| Shielding Effectiveness | > 90 dB (DC - 18 GHz) | | | | > 90 dB (DC - 12.4 GHz) | |
| Time Delay (nominal) | 1.24 ns/ft (4.07 ns/m) | | | | | |
| Dielectric Withstanding Voltage | 1500V | | | 1000V | | |

Mechanical / Environmental Properties

| StabilityTVAC™ Cable Type | TV-N-LL | TV-N-LL-LP | TV-SMA-LL | TV-SMA-LL-LP | TV-TNC-LL | TV-TNC-LL-LP |
|--|---------------------------------|------------------------|------------------------|------------------------|------------------------|------------------------|
| Center Conductor Material | Silver Plated Copper | | | | | |
| Maximum Outer Diameter (Connector) | 0.820 in (20.83mm) | | 0.35 in (9mm) | | 0.622 in (15.8mm) | |
| Maximum Outer Diameter (Cable) | 0.433 in (11.0mm) | 0.307 in (7.8mm) | 0.433 in (11.0mm) | 0.307 in (7.8mm) | 0.433 in (11.0mm) | 0.307 in (7.8mm) |
| Nominal Weight (Cable) | 1.37 oz/ft (128 g/m) | | | | | |
| Min. Static Bend Radius (Inch) / Min. Dynamic Bend Radius (Inch) | 2.16 in / 4.33 in | 1.535 in / 3.15 in | 2.16 in / 4.33 in | 1.535 in / 3.15 in | 2.16 in / 4.33 in | 1.535 in / 3.15 in |
| Flex Life Cycles | >500 | | | | | |
| Crush Resistance | 250 lbf/in (44 kgf/cm) | 27 lbf/in (4.8 kgf/cm) | 250 lbf/in (44 kgf/cm) | 27 lbf/in (4.8 kgf/cm) | 250 lbf/in (44 kgf/cm) | 27 lbf/in (4.8 kgf/cm) |
| Operating Temperature Range | -67°F to 329°F (-55°C to 165°C) | | | | | |
| RoHS/REACH | Yes | | | | | |
| Outgassing | TML<1%, CVCM< 0.1% | | | | | |

Max Insertion Loss/Attenuation

| Freq (GHz) | TV-N-LL (db/100 ft) | TV-N-LL-LP (db/100 ft) | TV-SMA-LL (db/100 ft) | TV-SMA-LL-LP (db/100 ft) | TV-TNC-LL (db/100 ft) | TV-TNC-LL-LP (db/100 ft) |
|------------|---------------------|------------------------|-----------------------|--------------------------|-----------------------|--------------------------|
| 0.5 | 3.16 | | 3.16 | | 3.16 | |
| 1 | 4.5 | | 4.5 | | 4.5 | |
| 1.5 | 5.54 | | 5.54 | | 5.54 | |
| 2 | 6.42 | | 6.42 | | 6.42 | |
| 3 | 7.92 | | 7.92 | | 7.92 | |
| 4 | 9.2 | | 9.2 | | 9.2 | |
| 5 | 10.34 | | 10.34 | | 10.34 | |
| 6 | 11.38 | | 11.38 | | 11.38 | |
| 8 | 13.25 | | 13.25 | | 13.25 | |
| 10 | 14.91 | | 14.91 | | 14.91 | |
| 12 | 16.44 | | 16.44 | | 16.44 | |
| 12.4 | 16.73 | | 16.73 | | 16.73 | |
| 13.75 | 17.69 | | 17.69 | | - | |
| 14.5 | 18.2 | | 18.2 | | - | |
| 18 | 20.47 | | 20.47 | | - | |

Max Insertion Loss/Attenuation

| Freq (GHz) | TV-N-LL Watts (Max) | TV-N-LL-LP Watts (Max) | TV-SMA-LL Watts (Max) | TV-SMA-LL-LP Watts (Max) | TV-TNC-LL Watts (Max) | TV-TNC-LL-LP Watts (Max) |
|------------|---------------------|------------------------|-----------------------|--------------------------|-----------------------|--------------------------|
| 0.5 | 2579 | | 2579 | | 2579 | |
| 1 | 1812 | | 1812 | | 1812 | |
| 1.5 | 1472 | | 1472 | | 1472 | |
| 2 | 1269 | | 1269 | | 1269 | |
| 3 | 1029 | | 1029 | | 1029 | |
| 4 | 886 | | 886 | | 886 | |
| 5 | 789 | | 789 | | 789 | |
| 6 | 717 | | 717 | | 717 | |
| 8 | 615 | | 615 | | 615 | |
| 10 | 547 | | 547 | | 547 | |
| 12 | 496 | | 496 | | 496 | |
| 12.4 | 487 | | 487 | | 487 | |
| 13.75 | 461 | | 461 | | - | |
| 14.5 | 448 | | 448 | | - | |
| 18 | 398 | | 398 | | - | |

Maury StabilityTVAC™ Cable Assembly Typical Performance

Maury StabilityTVAC™ 36" Cable Assembly Typical VSWR

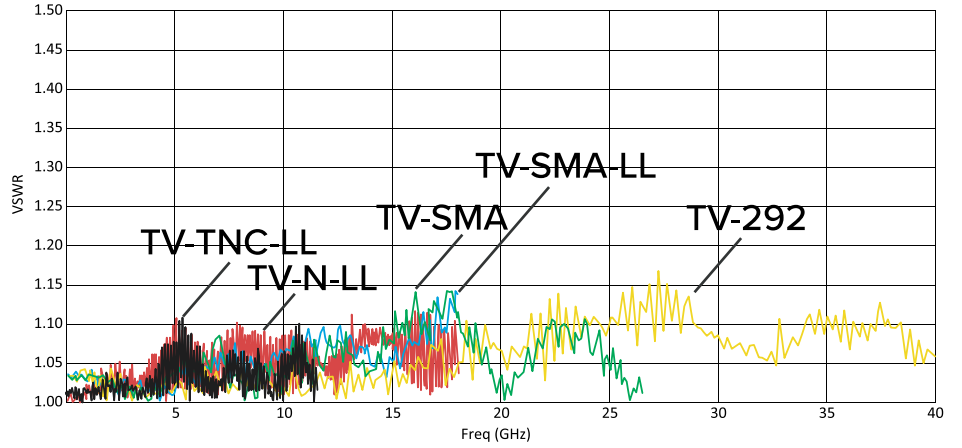

Maury StabilityTVAC™ 36" Cable Assembly Typical Insertion Loss

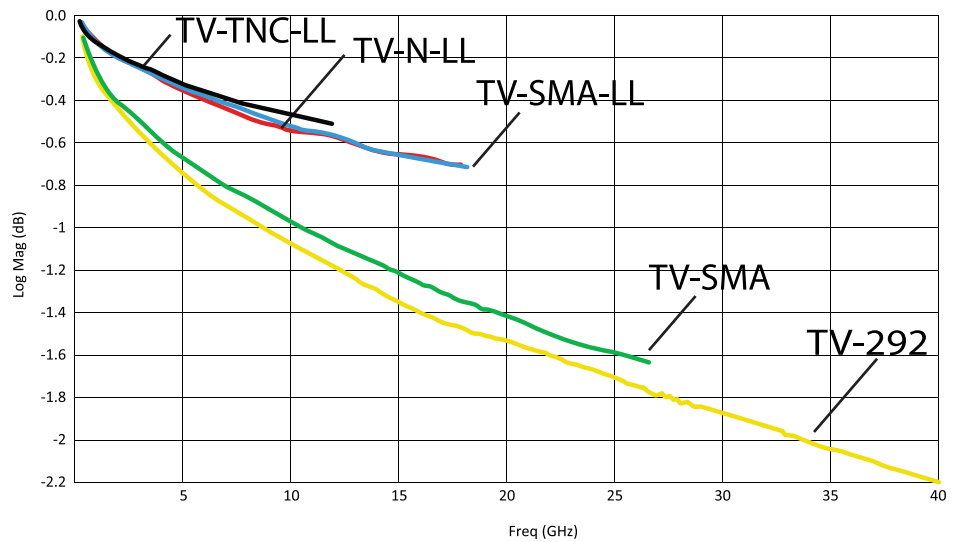

StabilityTVAC™
Dimensions

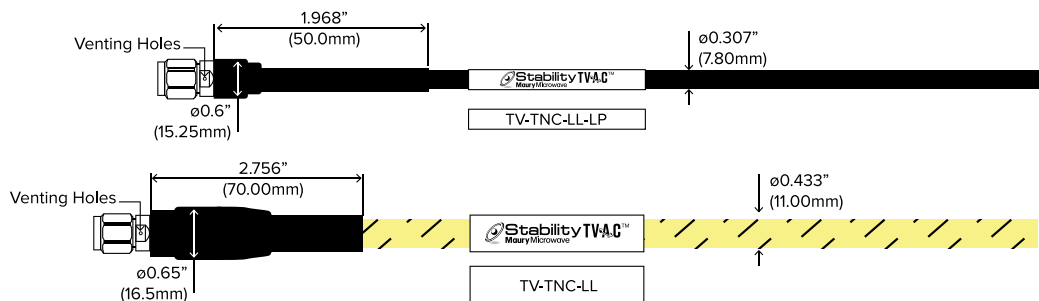
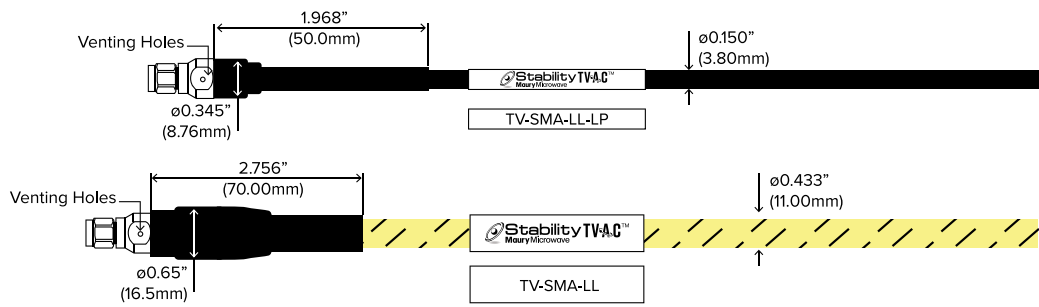
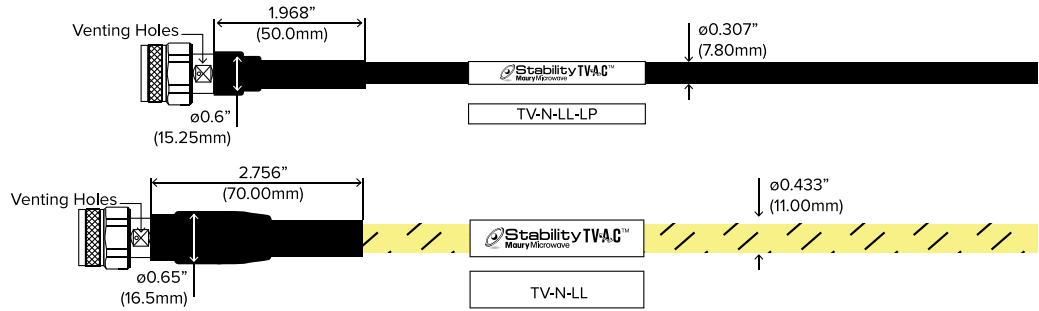
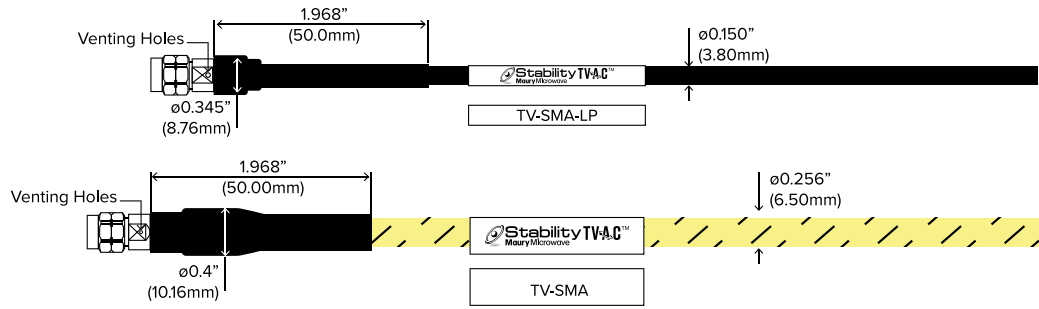
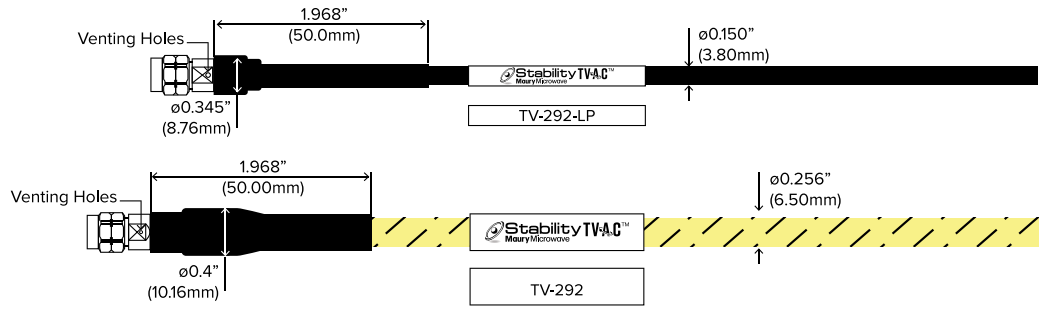

Phase Stability

The maximum value for phase and amplitude stability was established using the following method. The cable was terminated with a short. With the cable in a straight position the VNA was normalized. The cable was then coiled 360° around a mandrel 4 inches in diameter counter-clockwise and held in position for one sweep. The maximum deviation over the frequency range was recorded. The cable was then coiled 360° around the mandrel clockwise and held in position for one sweep and the maximum deviation was recorded. The cable was then returned to its original position for one sweep and the maximum deviation was recorded.

The plots on the right show the recorded worst-case phase variation.

Exemplary data for TV-292

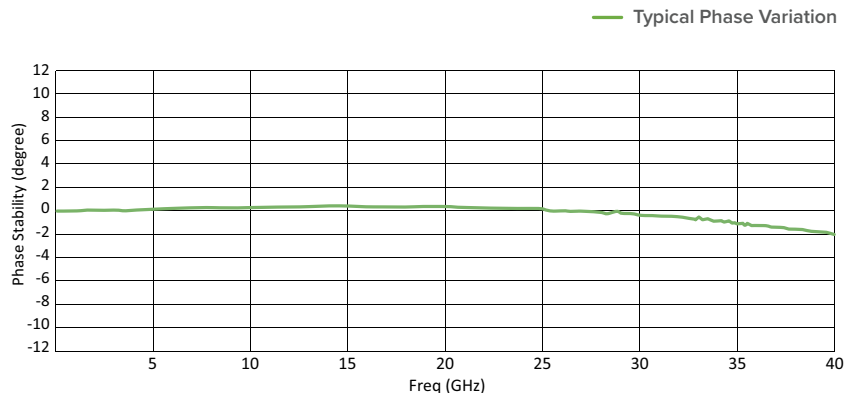

Exemplary data for TV-SMA

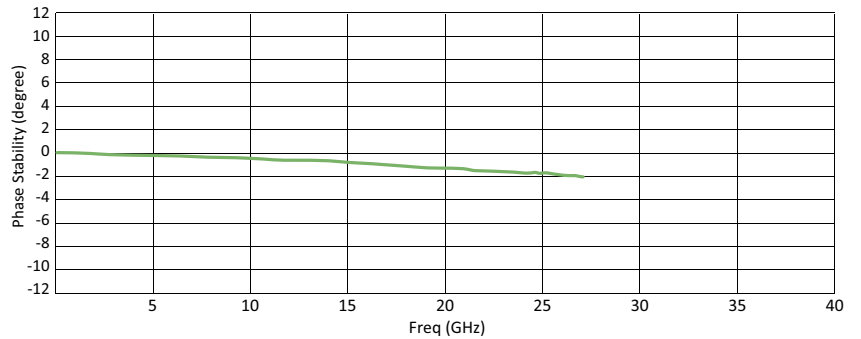

Exemplary data for TV-N-LL

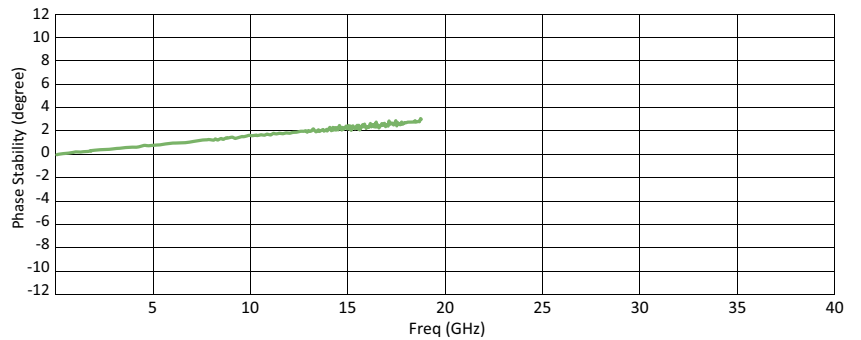

Exemplary data for TV-SMA-LL

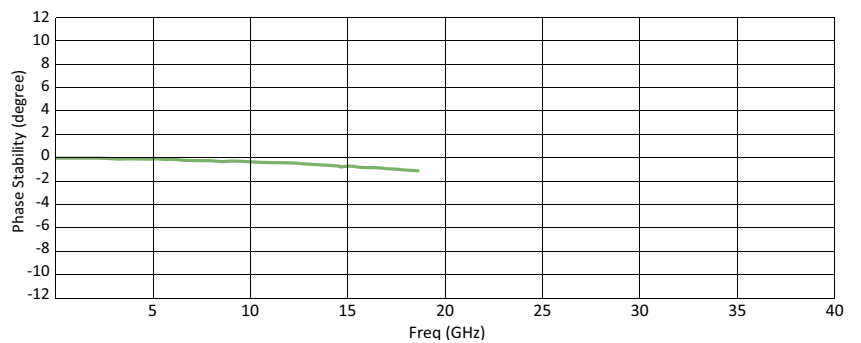

Exemplary data for TV-TNC-LL

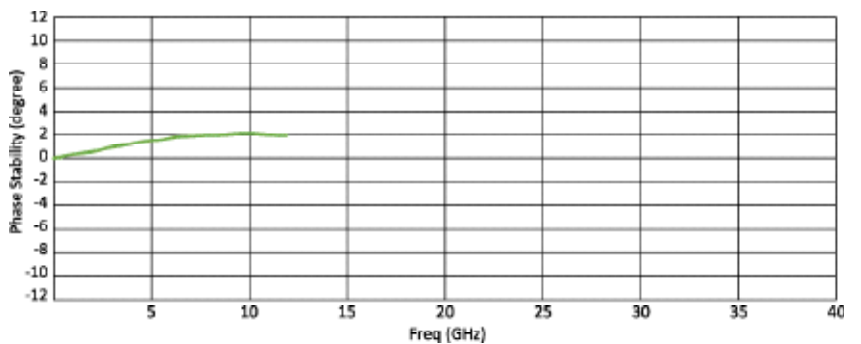

Ordering Instructions for StabilityTVAC™ Cable Assemblies

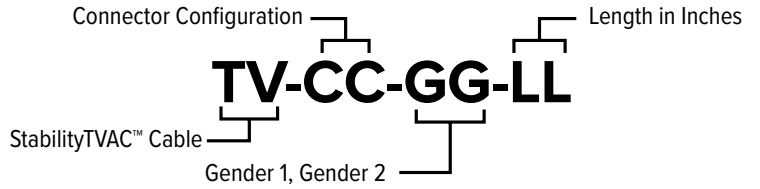

| CC | GG | LL | Optional |
|---------------------|---|---------------|------------------|
| 292 (2.92mm) SMA | MM (Male to Male) MF (Male to Female) FF (Female to Female) | Custom length | LP (Low Profile) |

EXAMPLE:

The following is a StabilityTVAC™ cable assembly with SMA male connectors on both ends, and 36 inches overall length.

Configuration Sample



EXAMPLE:

The following is a low-profile StabilityTVAC™ cable assembly with 2.92mm male connectors on both ends, and 36 inches overall length.

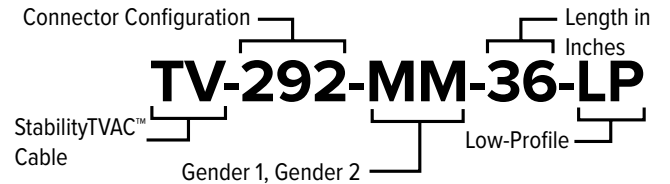

Ordering Instructions for Low-Loss StabilityTVAC™ Cable Assemblies

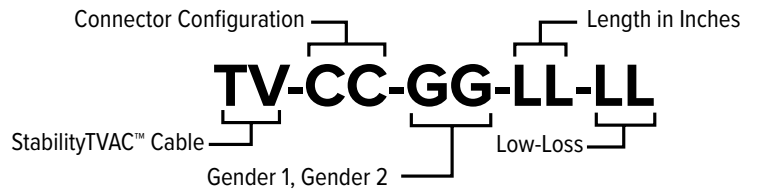

| CC | GG | LL | LL | Optional |
|--------------------------|---|---------------|----------|------------------|
| N (Type N) SMA TNC | MM (Male to Male) MF (Male to Female) FF (Female to Female) | Custom length | Low-loss | LP (Low Profile) |

EXAMPLE:

The following is a low-loss StabilityTVAC™ cable assembly with SMA male connectors on both ends, and 36 inches overall length.

Configuration Sample



EXAMPLE:

The following is a low-loss low-profile StabilityTVAC™ cable assembly with Type N male connectors on both ends, and 36 inches overall length.

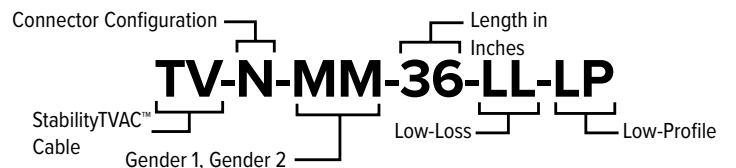

ColorConnect™ Precision Attenuators

AT-SERIES



AT-185-01-06

AT-24-01-03

AT-292-01-03

AT-SMA-02-03

AT-Series Attenuators

Features

- > Fixed Coaxial Attenuators
- > Precision 1.85mm, 2.4mm, 2.92mm & SMA Male/Female Connectors
- > Color Coded For Easy Identification

Description

Maury Microwave's AT-series of fixed coaxial attenuators are used to reduce the power of a RF, MW or mmW signal without distorting its signal quality/waveform. Attenuators are often used to lower the amplitude of a signal to a measurable level or to protect a measurement instrument from damage. Attenuators are also used to improve matching between components by improving the return loss (twice insertion loss) and effectively reducing the VSWR seen by adjacent components. Key attenuator parameters include attenuation, frequency bandwidth, power handling, VSWR and quality/repeatability of connector.

ColorConnect™ Color Coding

Maury AT-Series attenuators are part of the ColorConnect™ family. Following the proposed IEEE high-frequency connector/adaptor color convention, AT-Series attenuators are the first commercially available attenuators to offer clear indications of compatibility and intermatability. ColorConnect™ makes it a simple matter to avoid and eliminate damaged equipment, degraded equipment reliability, degraded performance and lengthy maintenance times due to improper mating (and attempted mating) of incompatible interconnects.

Available Models

| Model | Connector 1 | Connector 2 | Frequency Range | Power Handling (W) | Attenuation (dB) | VSWR (typical) | VSWR (max) |
|--------------|-------------|---------------|-----------------|--------------------|------------------|--|--|
| AT-SMA-02-01 | SMA male | SMA female | DC – 26.5 | 2 | 1 | See graph | DC-18 GHz 1.35:1 18-26.5 GHz 1.50:1 |
| AT-SMA-02-03 | | | | | 3 | | |
| AT-SMA-02-06 | | | | | 6 | | |
| AT-SMA-02-10 | | | | | 10 | | |
| AT-SMA-02-20 | | | | | 20 | | |
| AT-292-01-01 | 2.92mm male | 2.92mm female | DC – 40 | 1 | 1 | | DC-18 GHz 1.30:1 18-40 GHz 1.40:1 |
| AT-292-01-03 | | | | | 3 | | |
| AT-292-01-06 | | | | | 6 | | |
| AT-292-01-10 | | | | | 10 | | |
| AT-292-01-20 | | | | | 20 | | |
| AT-24-01-01 | 2.4mm male | 2.4mm female | DC – 50 | 1 | 1 | | DC-26.5 GHz 1.35:1 26.5-40 GHz 1.60:1 40-50 GHz 1.75:1 |
| AT-24-01-03 | | | | | 3 | | |
| AT-24-01-06 | | | | | 6 | | |
| AT-24-01-10 | | | | | 10 | | |
| AT-24-01-20 | | | | | 20 | | |
| AT-185-01-01 | 1.85mm male | 1.85mm female | DC – 65 | 1 | 1 | DC-26.5 GHz 1.35:1 26.5-40 GHz 1.55:1 40-65 GHz 1.65:1 | |
| AT-185-01-03 | | | | | 3 | | |
| AT-185-01-06 | | | | | 6 | | |
| AT-185-01-10 | | | | | 10 | | |
| AT-185-01-20 | | | | | 20 | | |



DATA SHEET
2R-020

ColorConnect™ Precision Attenuators Typical VSWR

AT-SMA, AT-292, AT-24 and AT-185

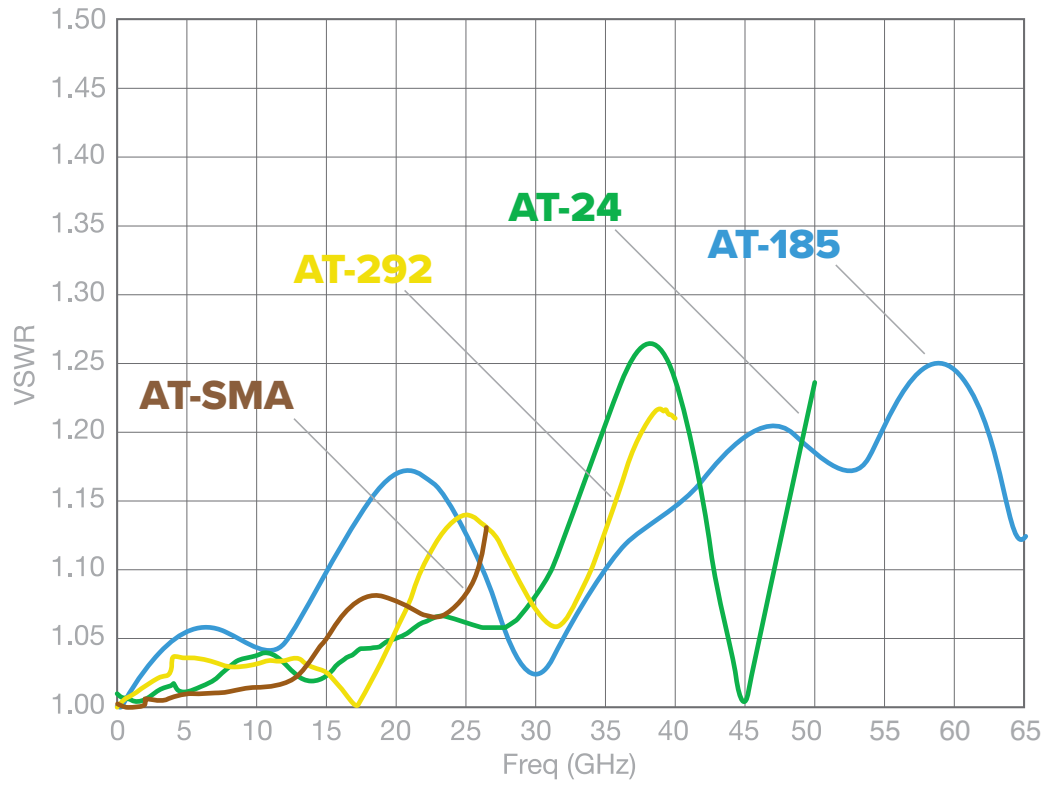

Torque Wrenches

ALL MODELS

Description

Maury's torque wrenches are recommended for tightening coaxial connectors in order to obtain optimum repeatability and prolong connector life. They employ a "break" design so it is impossible to over-torque a coupled junction, and torque can be applied in either direction. Each Maury torque wrench is factory preset to the proper in. lbs for tightening its coaxial connector type, and the color coded handles make it easy to select the correct wrench from your toolbox at a glance. The "TW" series has color coded bands corresponding to the Color Connect series identification.

Maury torque wrenches are included in many of our VNA calibration kits, and can be ordered separately by the model numbers listed in the chart below.

TW-8

TW-5

TW-12

2698K1

2698C2

8799A1

8799D1



Note: The models shown are delivered in a non-calibrated state unless calibration is requested at the time they are ordered. Maury highly recommends annual re-calibration of these torque wrenches to ensure their continued ability to properly tighten connections. Torque wrenches that are subject to heavy use should have their calibration checked more frequent.



DATA SHEET
2Y-050A

Available Models

| Model | For Use With Connector | Wrench Size (Inches) | Preset Torque (in.lbs.) | Handle Color ⁴ |
|---------------------|--|----------------------|-------------------------|---|
| 2698C2 | 7mm, N ¹ , NMD3.5, NMD2.92, NMD2.4, NMD1.85 | 0.75 HEX | 12 ±0.8 | BLUE |
| 2698G1 | TNC ² | 0.562 HEX | 12 ±0.8 | BLUE |
| 2698K1 | 7-16 | 1.062 HEX | 20 ±1.2 | GREEN |
| 8799A1 ³ | 3.5mm, 2.92mm, 2.4mm, 1.85mm | 0.312 HEX | 8 ±0.5 | RED |
| 8799D1 | SMA | 0.312 HEX | 5 ±0.3 | BLACK |
| TW-5 | SMA | 0.312 HEX | 5 ±0.5 | BROWN ⁵ |
| TW-8 | 3.5mm, 2.92mm, 2.4mm, 1.85mm, | 0.312 HEX | 8 ±0.8 | BLUE, GREEN, YELLOW, ORANGE ⁵ |
| TW-12 | 7mm, N ¹ , NMD3.5, NMD2.92, NMD2.4, NMD1.85 | 0.75 HEX | 12 ±1.2 | RED ⁵ |

¹ Precision N connectors supplied with 3/4 hex nuts.

² Precision TNC connectors supplied with 9/16 hex nuts.

³ WARNING: Do Not Use on SMA connectors. Damage can result.

⁴ Unless otherwise marked on nameplate, handle color represents torque value: blue = 12 in. lbs., red = 8 in. lbs., black = 5 in. lbs., gold = 20 in. lbs.

⁵ Has color coded bands corresponding to the Color Connect series identification.

Connector Gages and Connector Gage Kits

GENERAL INFORMATION

Features

- > Direct Reading, Self-Checking
- > Accurate, Easy to Use
- > Digital and/or Dial Indicator Styles



*A048A
1.85mm/2.4mm
Digital Connector
Gage Kit*

*A048A (Female) and
A048B (Male) Digital
Gages with Master
Blocks (Enlarged)*

Description

Maury connector gage kits provide an easy and accurate way to measure critical linear interface dimensions of most coaxial connectors. Each kit consist of gages with specially adapted indicators, and the bushings and pins needed to mate with specified connectors. Master setting gages are used to adjust the dial indicators (or digital indicators) to zero, before push-on or thread-on gages are mated with connectors to measure the distance from a given interface (male shoulder, etc.) to the outer conductor mating plane. The table below lists available models. Additional information is found in the referenced data sheets.

Why You Need Connector Gages

The Importance of checking the critical mechanical dimensions of your coaxial connectors before mating cannot be overstated. Superior electrical performance depends on making sure all the coaxial connectors in you test setup are operating within their specified tolerances. Pin depth and position of the center conductors are especially critical in that regard.

If the male and female contacts are recessed beyond tolerance they will exhibit a "gap-fit" connection when mated. This causes significant reduction of electrical performance.

If the male and female contacts protrude beyond their specified tolerances they will exhibit an "interference-fit" when mated. This will also degrade electrical performance, with adverse effects on measurement accuracy, and may result in catastrophic damage to the center connectors and contacts.

Since 1962 Maury Microwave has been designing connector gage kits that provide the best method of checking pin depth and position in all the most popular coaxial connector types. Today these include digital gage kits in 1.85mm/2.4mm and 2.92mm/3.5mm, 7mm, and Type N connector types, and dial-indicator gage kits in 1.85mm/2.4mm, 2.92mm/3.5mm, 7mm, type N (in 50 ohm and 75 ohm models), BNC, TNC, SMA and SMP/GPO™ connector types.

All Maury connector gage kits are designed for superior durability, stability and repeatability. Each kit includes at least one connector gage with the master gage block or blocks necessary to ensure the accuracy of the gages. Kits are available as metrology grade thread-on designs or hand-held push-on designs.

Available Models - Digital Indicator Style

| Connector Type | Dial Resolution (Inches) | Model ² | Description |
|------------------|--------------------------|--------------------|--|
| 1.85mm/2.4mm | 0.001mm/0.00004 in. | A048A | Two thread-on metrology grade digital gages measure female and male contact pin locations. |
| 2.92mm (K)/3.5mm | 0.001mm/0.00004 in. | A050A | Two thread-on metrology grade digital gages measure female and male contact pin locations. |
| Type N | 0.001mm/0.00004 in. | A020K | Two thread-on metrology grade digital gages measure type N female and male connectors, sliding loads, airlines, two-port standards, VNA test port adapters, etc. |
| 7mm | 0.001mm/0.00004 in. | A028F | One thread-on metrology grade digital gage measure 7mm connectors. |

¹ GPO™ is a trademark of the Gilbert Engineering Co., Inc.

² Please reference to data sheet 2Y-051 for individual model details.



DATA SHEET
2Y-051

Available Models - Dial Indicator Style

| Connector Type | Dial Resolution (Inches) | Model ² | Description |
|-----------------------|--------------------------|--------------------|---|
| 2.92mm (K)/ 3.5mm | 0.00025 | A034B1 | Two push-on gages measure female and male contact pin interface locations. |
| 2.92mm (K)/ 3.5mm | 0.0001 | A034E | Two metrology grade thread-on gages measure female and male contact pin interface locations. |
| 1.85/2.4mm | 0.0001 | A035E | Two metrology grade thread-on gages measure female and male contact pin interface locations. |
| 7mm | 0.0001 | A028D | One thread-on metrology grade gage measures planar contact location. |
| Type N | 0.001 | A007A | One push-on gage measures female and male contact pin location. |
| Type N | 0.00025 | A020A | One push-on gage measures female and male contact pin location. |
| Type N | 0.0001 | A020D | Two metrology grade thread-on gages measure female and male contact pin interface locations. |
| Type N (75 ohms) | 0.00025 | A020G | One push-on gage measures female and male contact pin location of 75 ohm type N connectors. |
| BNC/TNC | 0.0005 | A012A | One push-on gage measures female and male contact pin and dielectric interface locations. |
| SMA | 0.0005 | A027P1 | Two push-on gages measure female and male contact pin interface locations. |
| SMA | 0.0005 | A027A1 | Four push-on gages measure female and male contact pin and dielectric interface locations. |
| SMA | 0.0005 | A027G1 | Two push-on gages measure female contact pin and dielectric interface locations. |
| SMA | 0.0005 | A027M1 | Three push-on gages measure standard male contact pin and dielectric interface locations, and the stepless 0.085-inch male pin dimension. |
| SMP/GPO™ ¹ | 0.0005 | A042A | Three push-on gages measures SMP connectors' contact pin and dielectric interface locations. |

¹ GPO™ is a trademark of the Gilbert Engineering Co., Inc.

² Please reference to data sheet 2Y-051 for individual model details.

Precision Calibration Solutions





—PRECISION CALIBRATION SOLUTIONS

Insight VNA Calibration and Measurement Software



Introduction

From their introduction in the 1980s, Vector Network Analyzers, VNAs, have been used to measure network scattering parameters, S-parameters, of linear electrical networks. Since that time, S-parameters have become so common that they are used in nearly all aspects of an RF device's life cycle including research and development, design validation test and production test.

It is not uncommon to walk into an RF lab and see VNAs from various vendors spanning multiple generations being used interchangeably, from the original HP 8510 to the latest Keysight PNA-X. With so many different VNAs in use, each with different interfaces and capabilities, several challenges arise:

- > How can we ensure VNA users are properly trained on every model available in their labs?
- > How can simple mistakes due to differences in terminologies, calibration standards definitions and calibration flows be avoided?
- > How can we validate VNA calibrations in a meaningful way so that users can have confidence in their measurements?

And it's not enough to think about a single lab; today's global organizations have multiple labs across various countries and multinational teams that collaborate on projects. This introduces another set of challenges:

- > How can users save important measurement data in a format that is usable by everyone?
- > How can the visualization and analysis process be simplified yet made more powerful to that better decisions can be made more efficiently?

And finally, as we strive to understand more about our RF device's performance, challenges related to uncertainty arise:

- > How can we identify all the sources of uncertainty in our measurement setup?
- > How can we quantify the uncertainty and use it in making better decisions?

Insight VNA Calibration and Measurement Software

Welcome to Insight, the industry's first commercial software suite designed to empower VNA users and help them make better decisions. Insight represents a paradigm shift in the way users approach VNA calibration, validation, measurement, visualization and analysis. With Insight, users can:

- > Use a single software platform with most commercial VNAs*
- > Define mechanical calibration standards from any vendor and use with all VNAs
- > Avoid common errors with a simplified calibration process empowered by an intuitive GUI and wizard
- > Validate VNA calibration using airlines and individually characterized verification kits
- > Measure S-parameters and save S2P files for easy sharing
- > Understand measurement results better with advanced visualization and analysis tools
- > Identify and quantify the individual contributions of uncertainty**
- > Display uncertainty boundaries alongside measurement results

** Insight ships with an extensive library of VNA drivers; additional drivers may be added upon request*

***Utilizing techniques described by EURAMET*



DATA SHEET
4T-023

MT940A Insight Calibration and Measurement

MT940A Insight Calibration and Measurement software module includes everything needed to calibrate a VNA, validate VNA calibration, measure an RF device's S-parameters, and visualize and analyze the measurement results. Features of MT940A include:

- > System library
- > Calibration wizard
- > Calibration validation wizard
- > Real-time measurement interface
- > Visualization and data analysis tool

System library

The system library is the database of instruments and accessories used to calibrate, validate and measure an RF devices' S-parameters. This includes:

- > VNA – create a database of available VNAs including selecting the appropriate VNA driver and defining the GPIB or network address
- > Cal kits – create a database of available VNA calibration kits, including connector type and gender, and whether the kit uses polynomial definitions or individually Characterized Device (CD) standards
- > Verification kits – create a database of available Maury VNA calibration verification kits



Calibration wizard

The calibration wizard guides users through the calibration process, including:

- > Selecting the VNA from the database and defining the VNA properties (port numbers, power, averaging, IF bandwidth...)
- > Defining the frequencies for calibration (linear step or custom list)
- > Selecting the calibration kit from the dataset and defining the calibration method
- > Calibrating by connecting and measuring each standard and computing error terms

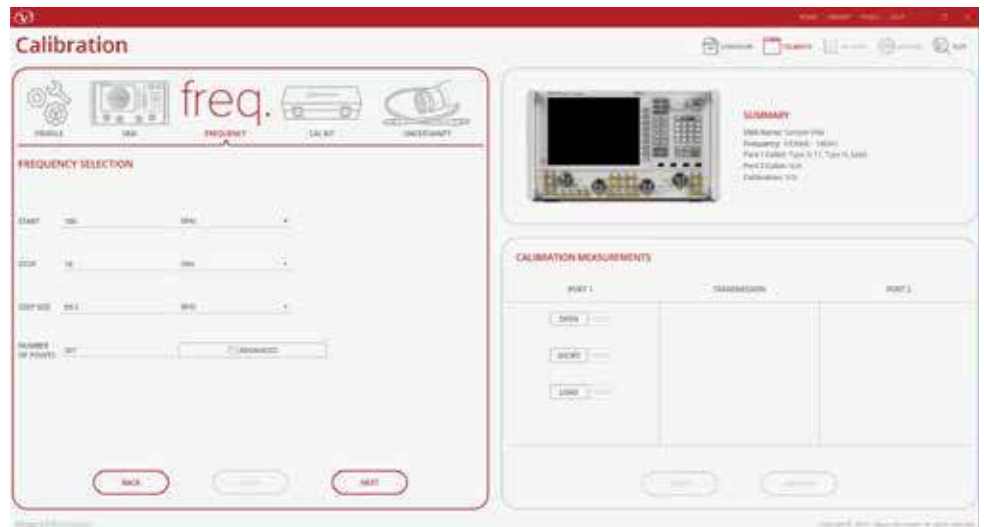

Calibration validation wizard

The calibration validation wizard guides users through the validation process, including:

- > Selecting the VNA calibration verification kit from the database
- > Validating Source Match using beadless airlines
- > Validating using Characterized Device (CD) verification kit which compares a user's measured data against factory-measured data and calculates error vector

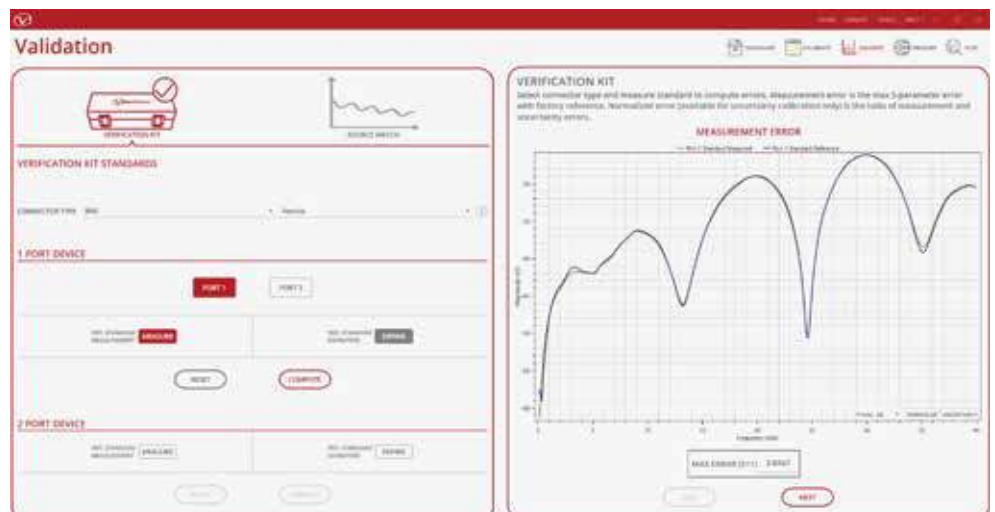

Real-time measurement interface

The real-time measurement interface empowers RF device measurements, including:

- > Setting VNA options (IF bandwidth, averaging, port power)
- > Defining plots to visualize measurement data
- > Setting sweep mode (single, continuous, hold)
- > Saving measurement data to memory or as S2P files
- > Comparing/normalizing data sets for analysis
- > Creating specifications files for comparison and analysis



Visualization and data analysis tool

The visualization and data analysis tool empowers users to visualize and analyze measurement data, by:

- > Creating, saving and sharing visualization templates, or use a quick plot, to ensure consistent and repeatable measurement analysis
- > Creating sessions (template and measurements data) to share among collaborators
- > Loading and comparing multiple saved data sets
- > Creating custom expressions from measured S-parameters
- > Exporting data as CSV and image files

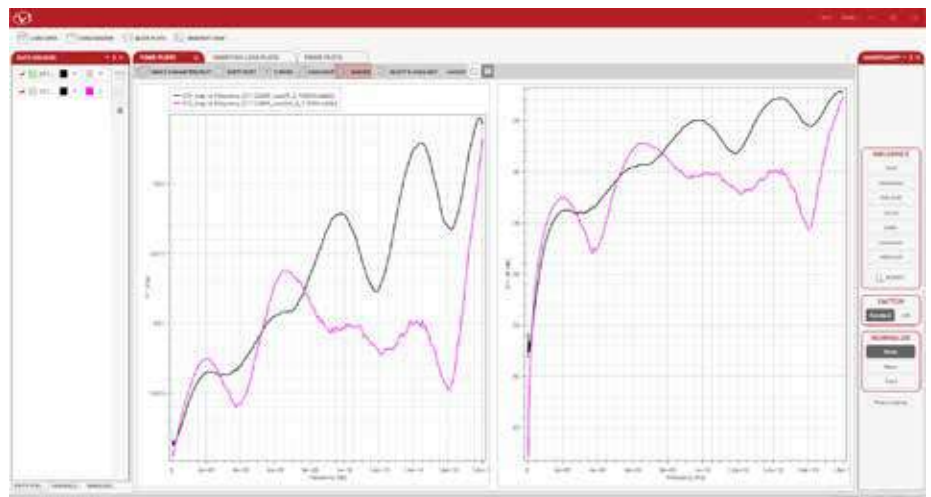

MT940B Insight Real Time Uncertainty Add-On

MT940B is an add-on module for MT940A which enables real-time uncertainty analysis based on EURAMET guidelines, including:

- > Uncertainty quantification
- > Uncertainty calibration validation
- > Uncertainty measurements
- > Uncertainty budget

Uncertainty quantification

Identifies and quantifies the uncertainty contribution of each component in a measurement setup. This includes:

- > VNA – characterize VNA drift and noise floor
- > Cal kit – load factory uncertainty data
- > Cables – characterize the transmission and reflection stability of the cables used in a measurement setup (related to amplitude and phase stability with flexure)
- > Connectors – characterize connector repeatability of the connectors used in a measurement setup (related to the impact of pin depth, concentricity, user etiquette)

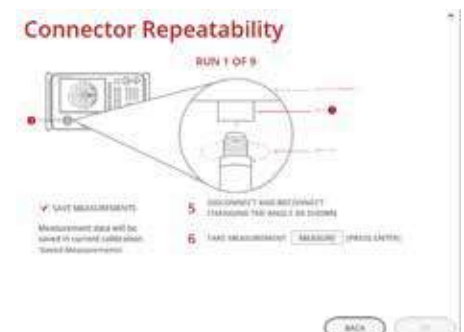
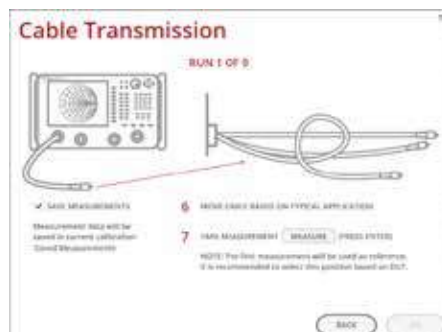
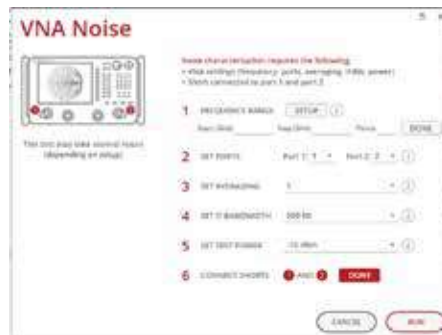

Uncertainty calibration validation

When used with a Characterized Device (CD) calibration kit and Characterized Device (CD) verification kit, uncertainty calibration validation compares the uncertainty boundaries measured on a verification device by the user with the uncertainty boundaries measured on the same verification device at the factory, and defines a passing validation as one where the measurement uncertainty boundaries overlap.

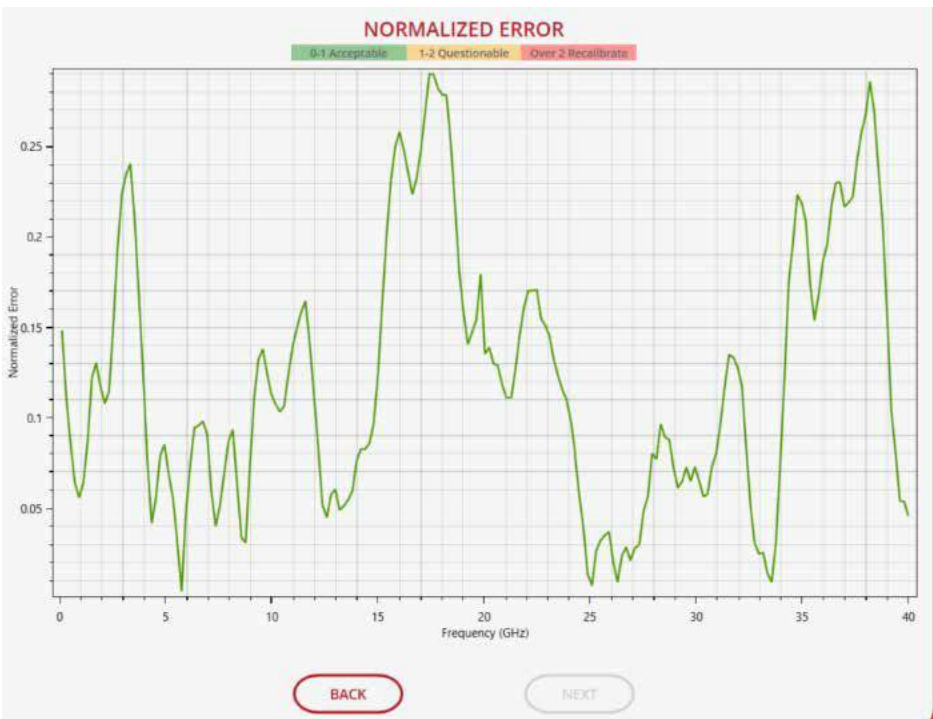
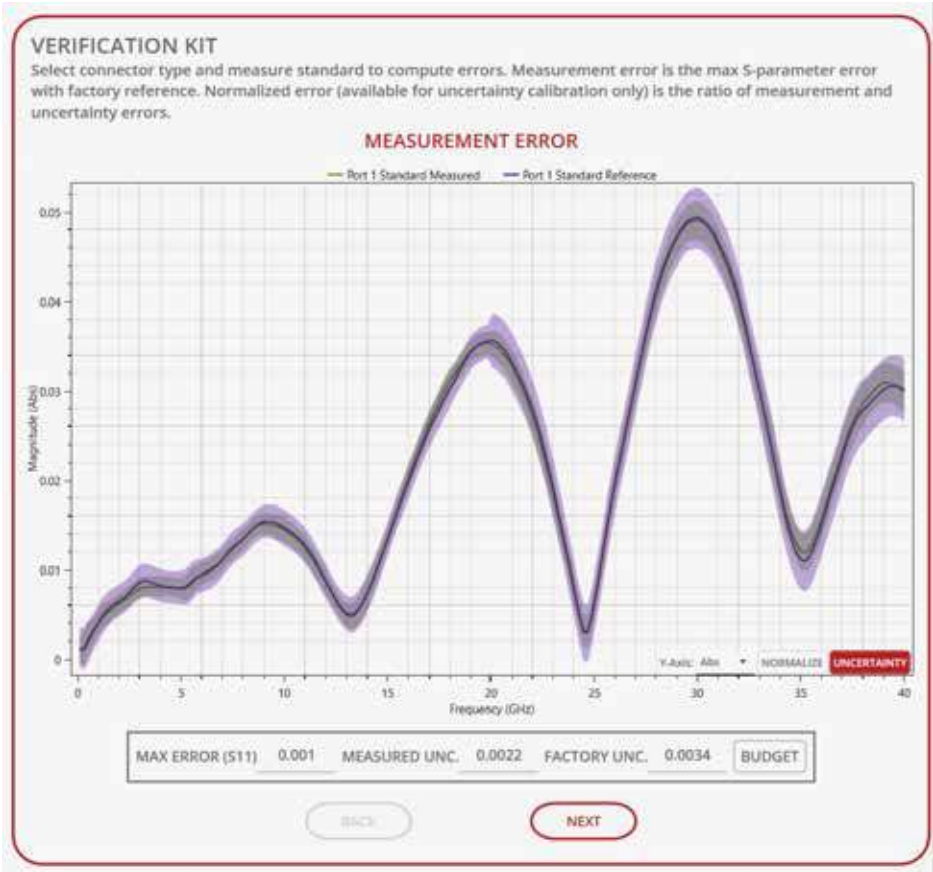

Uncertainty measurements

Individual uncertainty contributors can be activated, or de-activated and measurement data can be plotted with uncertainty boundaries.

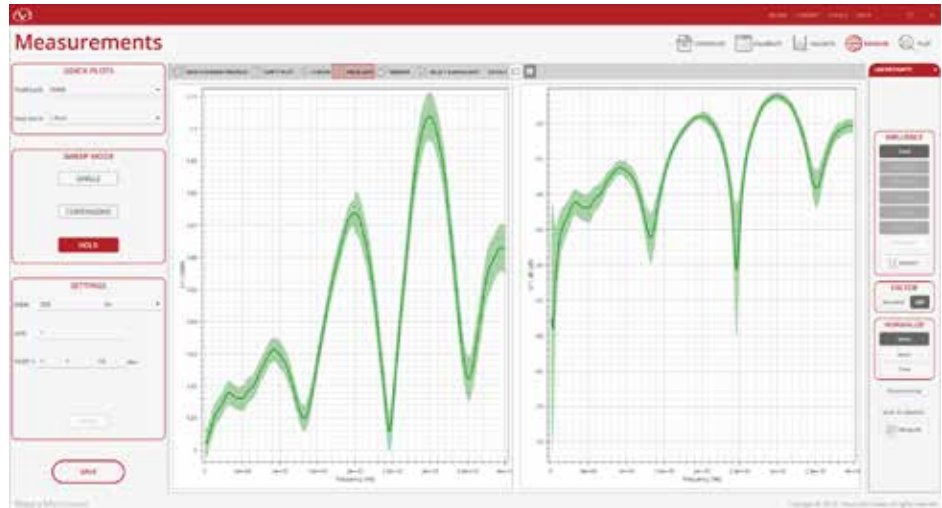

Uncertainty budget

Reports the individual uncertainty contributions of VNA, cal kit, cable and connector as a percentage of the total for each frequency and enables users to concentrate on improving the largest contributors for more certain measurement results.

| Uncertainty Budget Info | | | | | | | | | | | | | | | | | | | | | | | | | | | | | | |
|-------------------------|-----------------------|---------------|---|----------------|---------------|----------------|-----------------|------------|---------|-----------------|------------|---------|---------------|------------|---------|-----------------------|------------|---------|--------------------|------------|---------|-----------------|------------|---------|----------------------|------------|----------|---------|------------|----------|
| Data Source | Parameter | Freq. (GHz) | Uncertainty Budget | | | | | | | | | | | | | | | | | | | | | | | | | | | |
| Measured Data | S11_real | 35.76818181 | Data: Measured Data Parameter: S11_VSWR Frequency: 40 GHz <table border="1"> <thead> <tr> <th>DESCRIPTION</th> <th>UNC COMPONENT</th> <th>UNC PERCENTAGE</th> </tr> </thead> <tbody> <tr> <td>VNA NOISE FLOOR</td> <td>2.137E-005</td> <td>0.003 %</td> </tr> <tr> <td>VNA NOISE TRACE</td> <td>2.804E-004</td> <td>0.523 %</td> </tr> <tr> <td>VNA LINEARITY</td> <td>1.402E-004</td> <td>0.131 %</td> </tr> <tr> <td>VNA DRIFT DIRECTIVITY</td> <td>9.945E-004</td> <td>6.582 %</td> </tr> <tr> <td>VNA DRIFT TRACKING</td> <td>6.913E-005</td> <td>0.032 %</td> </tr> <tr> <td>VNA DRIFT MATCH</td> <td>9.064E-007</td> <td>0.000 %</td> </tr> <tr> <td>CONNECTOR REFLECTION</td> <td>2.674E-003</td> <td>47.572 %</td> </tr> <tr> <td>CAL KIT</td> <td>2.605E-003</td> <td>45.158 %</td> </tr> </tbody> </table> | DESCRIPTION | UNC COMPONENT | UNC PERCENTAGE | VNA NOISE FLOOR | 2.137E-005 | 0.003 % | VNA NOISE TRACE | 2.804E-004 | 0.523 % | VNA LINEARITY | 1.402E-004 | 0.131 % | VNA DRIFT DIRECTIVITY | 9.945E-004 | 6.582 % | VNA DRIFT TRACKING | 6.913E-005 | 0.032 % | VNA DRIFT MATCH | 9.064E-007 | 0.000 % | CONNECTOR REFLECTION | 2.674E-003 | 47.572 % | CAL KIT | 2.605E-003 | 45.158 % |
| | DESCRIPTION | UNC COMPONENT | | UNC PERCENTAGE | | | | | | | | | | | | | | | | | | | | | | | | | | |
| | VNA NOISE FLOOR | 2.137E-005 | | 0.003 % | | | | | | | | | | | | | | | | | | | | | | | | | | |
| | VNA NOISE TRACE | 2.804E-004 | | 0.523 % | | | | | | | | | | | | | | | | | | | | | | | | | | |
| | VNA LINEARITY | 1.402E-004 | | 0.131 % | | | | | | | | | | | | | | | | | | | | | | | | | | |
| | VNA DRIFT DIRECTIVITY | 9.945E-004 | | 6.582 % | | | | | | | | | | | | | | | | | | | | | | | | | | |
| | VNA DRIFT TRACKING | 6.913E-005 | | 0.032 % | | | | | | | | | | | | | | | | | | | | | | | | | | |
| | VNA DRIFT MATCH | 9.064E-007 | | 0.000 % | | | | | | | | | | | | | | | | | | | | | | | | | | |
| | CONNECTOR REFLECTION | 2.674E-003 | | 47.572 % | | | | | | | | | | | | | | | | | | | | | | | | | | |
| | CAL KIT | 2.605E-003 | | 45.158 % | | | | | | | | | | | | | | | | | | | | | | | | | | |
| | S11_imag | 35.96069696 | | | | | | | | | | | | | | | | | | | | | | | | | | | | |
| | S11_db | 36.17121212 | | | | | | | | | | | | | | | | | | | | | | | | | | | | |
| | S11_mag | 36.37272727 | | | | | | | | | | | | | | | | | | | | | | | | | | | | |
| | S11_angle_deg | 36.57424242 | | | | | | | | | | | | | | | | | | | | | | | | | | | | |
| | S11_angle_rad | 36.77575757 | | | | | | | | | | | | | | | | | | | | | | | | | | | | |
| | S11_VSWR | 36.97727272 | | | | | | | | | | | | | | | | | | | | | | | | | | | | |
| | | 37.17878787 | | | | | | | | | | | | | | | | | | | | | | | | | | | | |
| | | 37.38030303 | | | | | | | | | | | | | | | | | | | | | | | | | | | | |
| | | 37.58181818 | | | | | | | | | | | | | | | | | | | | | | | | | | | | |
| | | 37.78333333 | | | | | | | | | | | | | | | | | | | | | | | | | | | | |
| | 37.98484848 | | | | | | | | | | | | | | | | | | | | | | | | | | | | | |
| | 38.18636363 | | | | | | | | | | | | | | | | | | | | | | | | | | | | | |
| | 38.38787878 | | | | | | | | | | | | | | | | | | | | | | | | | | | | | |
| | 38.58939393 | | | | | | | | | | | | | | | | | | | | | | | | | | | | | |
| | 38.79090909 | | | | | | | | | | | | | | | | | | | | | | | | | | | | | |
| | 38.99242424 | | | | | | | | | | | | | | | | | | | | | | | | | | | | | |
| | 39.19393939 | | | | | | | | | | | | | | | | | | | | | | | | | | | | | |
| | 39.39545454 | | | | | | | | | | | | | | | | | | | | | | | | | | | | | |
| | 39.59696969 | | | | | | | | | | | | | | | | | | | | | | | | | | | | | |
| | 39.79848484 | | | | | | | | | | | | | | | | | | | | | | | | | | | | | |
| | 40 | | | | | | | | | | | | | | | | | | | | | | | | | | | | | |

A Note About Validating a Calibration by Using Uncertainty Boundaries

Validation is by far the most important step in a measurement process; without validating, how can RF device measurements be trusted?

Conventional validation techniques rely on an estimate of the residual errors after a calibration, source match, directivity and tracking, and are typically evaluated by measuring peak-to-peak ripple through a TDR method. These techniques rely on an airline as the validation standard, and the accuracy of the validation can be severely impacted by how well the airline has been machined and handled.

A more thorough approach is based on the use of verification standards. This method involves a user measuring pre-characterized verification devices with similar performances to their own device. However, there is no clear pass-fail criteria that identifies whether a calibration is sufficiently accurate to proceed to device measurement, or whether a calibration needs to be repeated.

Insight solves the problem by defining clear pass-fail criteria based on using uncertainty boundaries. When the uncertainty boundaries measured on a verification device by the user overlaps the uncertainty boundaries measured on the same verification device at the factory, it is defined as an accurate calibration. If the boundaries do not overlap, then recalibration is recommended. Insight automates this process by guiding users through the calibration validation and clearly identifies whether the calibration can be used or must be repeated

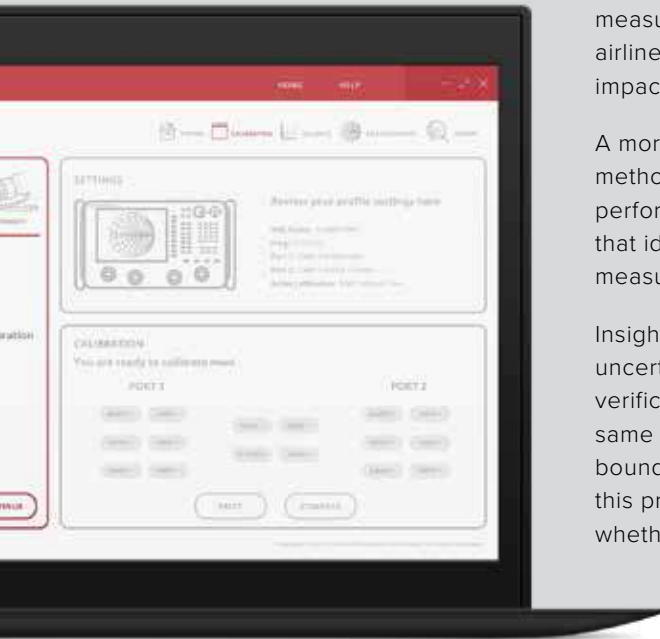

Recommended Accessories

Verification Kits:

Have confidence in your S-parameter measurements by validating your VNA calibration. Maury verification kits are designed for 1-port and 2-port VNA calibration validation for well-matched and mismatched DUTs by comparing the S-parameters of user-characterized and factory-characterized verification standards, with or without measured uncertainty boundaries. More information regarding Verification Kits can be found in data sheet [2Z-077](#).

VNA Calibration Kits:

Maury offers coaxial VNA calibration kits up to 67 GHz and waveguide calibration kits up to 50 GHz in standard connector and waveguide sizes. Coaxial 2.4mm, 2.92mm, 3.5mm, 7mm and Type N calibration kits are available as fixed-load SOLT kits with either standard polynomial equations or characterized device (CD) with individually characterized standards. More information can be found in data sheets [2Z-056 \(1.85mm\)](#), [2Z-072 \(2.4mm\)](#), [2Z-073 \(2.92mm\)](#), [2Z-074 \(3.5mm\)](#), [2Z-075 \(7mm\)](#), and [2Z-076 \(Type N\)](#), [2Z-062 \(TNC\)](#), [2Z-069 \(BNC\)](#) and [3H-081 \(WR284 Through WR22\)](#).

Maury Precision VNA Calibration Kits



Network Analyzer Calibration Methodologies

Why do we need to calibrate?

Systematic errors that are present in any measurement equipment and setup must be removed in order to measure a DUT accurately. The basis of network analyzer error correction is the measurement of known electrical standards, such as a through, open circuit, short circuit, and precision load impedance. By calibrating your network analyzer with these known standards, you can connect for systematic errors that are a result of the VNA itself along with errors due to measurement setup (cables, adapters, fixtures, etc). The information below addresses some of the most critical factors in VNA calibration, ending with a brief survey of the more widely used calibration methodologies that can be performed with Maury Precision VNA Calibration Kits.

Calibration Procedures

Calibration procedures include the popular Short-Open-Load or Short-Open-Load-Thru (SOLT) calibration technique, SSLT for waveguide, and Thru-Reflect-Line (TRL).

Sources and Types of Errors

All measurement systems, including those employing network analyzers, have three types of measurement errors:

- > Systematic errors
- > Random errors
- > Drift errors

Systematic errors are caused by imperfections in the test equipment and test setup. As the name suggests, systematic errors are non random in nature and hence can be characterized through calibration and removed during device measurements. Random and drift errors cannot be systematically be characterized and can affect measurement accuracy if the measurement setup and equipment are not validated prior to device measurement.

Error Correction

Vector error correction is the more thorough method of removing systematic errors. This type of error correction requires a network analyzer capable of measuring (but not necessarily displaying) phase as well as magnitude, and a set of calibration standards with known, precise electrical characteristics.

The vector-correction process requires the open, short, load, and sometimes thru calibration standards. The two main types of vector error correction are the one-port and two-port calibrations.

One-Port Calibration

A one-port calibration can measure and minimize three systematic error terms (directivity, source match, and reflection tracking) from reflection measurements. Three known calibration standards must be measured, such as a Short, Open, and a Load (the load value is usually the same as the characteristic impedance of the test system, generally either 50 or 75 ohm). One-port calibration makes it possible to derive the DUT's actual reflection S-parameters.

Two-Port Error Correction

Two-port error correction yields the most complete calibration because it accounts for the three major sources of systematic error addressed by one-port calibration at both ports of a two-port DUT. Traditional full two-port calibrations utilize three impedance standards and one transmission standard to define the calibrated reference plane. These standards, typically a Short, Open, Load, and Thru, make up the SOLT calibration kit. The most common Thru used is the test ports connected directly together.

Fixed-Load SOLT using Polynomial Equations

SOLT calibration is performed using Short, Open and Load standards, which are described by a polynomial equation. The equation is developed using the average performance of a large sample of identical standards, and is then shared by all calibration kits of the same series. In addition, the fixed-load SOLT methodology

uses a fixed termination to define the 50ohm reference, where the lowest measurable return loss is determined by the return loss of the fixed termination, typically better than 20dB. This makes fixed-load SOLT with polynomial definitions ideal for measuring devices with mid-range reflection coefficients.

Fixed-Load SOLT using Characterized Device (CD) Standards

SOLT calibration can also be performed using individually characterized standards, referred to as Characterized Device (CD) fixed-load SOLT calibration. In this case, each standard is individually measured and its S-parameters are used as an integral part of the calibration, and the polynomial equation is no longer used. The advantage of this technique is that the calibration accuracy is increased due to the elimination of average performance in the polynomial definition, and the lowest measurable return loss is improved.

Calibrating with Uncertainty

Characterized Device (CD) kits also allow for uncertainty evaluation of a device under test. Each CD kit is shipped with a set of factory uncertainty data compatible with MT940-series Insight VNA calibration and measurement software.

TRL Calibration

Following SOLT in popularity, the next most common form of two-port calibration is called a Thru-Reflect-Line (TRL) calibration. TRL corrects the same error terms as a SOLT calibration, although it uses different calibration standards.

Other variations of TRL are Line-Reflect-Line (LRL), (LRM) based on Line-Reflect-Match (load) calibration standards or Thru-Reflect-Match (TRM) calibration standards.

In non-coaxial applications such as waveguide, TRL usually achieves better source match and load match corrections than SOLT. While not as commonly used, coaxial TRL can also provide more accuracy than SOLT, but only if very-high quality coaxial transmission lines (such as beadless airlines) are used.

1.85mm VNA Calibration Kits

7850CK30/31 SERIES

These precision 1.85mm TRL/LRL calibration kits are designed for use with a broad range of vector network analyzers (VNAs) and are used to make error-corrected measurements, from DC to 67 GHz, for devices supplied with 1.85mm connectors. Each kit includes a full complement of calibration standards (shorts, fixed loads and air lines). Three 1.85mm in-series, calibration-grade (metrology), adapters are included in the 7850CK31 kits but are not included in the 7850CK30 kits. All kit components are provided in an attractive foam-lined, wood instrument case.

Features

- > 1.85mm Connectors
- > DC to 67 GHz (Operates to 70 GHz)
- > Keysight, Rohde & Schwarz and Anritsu VNAs Supported

Calibration Methods Supported

- > TRM – Thru-Reflect-Match (DC to 800 MHz)
- > TRL – Thru-Reflect-Line (800 MHz to 13.0 GHz)
- > LRL – Line-Reflect-Line (13.0 to 67.0 GHz)

7850CK30



7850CK31



Components Included in 7850CK30 Kits

| QUANTITY | DESCRIPTION | MODEL |
|----------|---|-----------|
| 1 | 1.85mm female fixed short circuit (0.5cm) | 7846A |
| 1 | 1.85mm male fixed short circuit (0.5cm) | 7847A |
| 1 | 1.85mm female fixed termination | 7831A1 |
| 1 | 1.85mm male fixed termination | 7831B1 |
| 1 | 1.85mm female to male air line (0.96cm) | 7843S0.96 |
| 1 | 1.85mm female to male air line (1.15cm) | 7843S1.15 |
| 1 | 1.85mm female to male air line (3.00) | 7843S3.00 |
| 1 | Torque wrench (8 in. lbs) | 8799A1 |
| 1 | 5/16-inch double end wrench | 8770Z6 |
| 1 | 3/16-inch double end wrench | 7960Z1 |
| 1 | Foam-lined wood instrument case | — |

Components Included in 7850CK31 Kits

| QUANTITY | DESCRIPTION | MODEL |
|----------|---|-----------|
| 1 | 1.85mm female fixed short circuit (0.5cm) | 7846A |
| 1 | 1.85mm male fixed short circuit (0.5cm) | 7847A |
| 1 | 1.85mm female fixed termination | 7831A1 |
| 1 | 1.85mm male fixed termination | 7831B1 |
| 1 | 1.85mm female to male air line (0.96cm) | 7843S0.96 |
| 1 | 1.85mm female to male air line (1.15cm) | 7843S1.15 |
| 1 | 1.85mm female to male air line (3.00) | 7843S3.00 |
| 1 | 1.85mm female to 1.85mm female | 7821A |
| 1 | 1.85mm male to 1.85mm male | 7821B |
| 1 | 1.85mm female to 1.85mm male | 7821C |
| 1 | Torque wrench (8 in. lbs) | 8799A1 |
| 1 | 5/16-inch double end wrench | 8770Z6 |
| 1 | 3/16-inch double end wrench | 7960Z1 |
| 1 | Foam-lined wood instrument case | — |



DATA SHEET
2Z-056

2.4mm VNA Calibration Kits

7950CK40/41 SERIES AND
7950CK50/51 SERIES

Features

- > 2.4mm Connectors
- > DC to 50 GHz
- > Compatible with Insight calibration SW and uncertainty analysis*
- > Keysight, Rohde & Schwarz and Anritsu VNAs Supported

Calibration Methods Supported

- > 7950CK40/41 – Fixed Load SOLT (DC–50 GHz)
- > 7950CK50/51 – Characterized Device (CD) SOLT (0.05–50 GHz)

7950CK40



7950CK41



Maury precision 2.4mm VNA calibration kits include each of the calibration standards and tools shown in the tables at the right. The 7950CK40/50 kits do not include adapters; the 7950CK41/51 kits include one each of the in-series adapters shown. Other in-series and between series adapters are sold separately.

Components Included in 7950CK40/41 Kits

| QUANTITY | DESCRIPTION | MODEL |
|----------|---------------------------------------|--------|
| 1 | 2.4mm female fixed short circuit | 7946A2 |
| 1 | 2.4mm male fixed short circuit | 7946B2 |
| 1 | 2.4mm female open circuit termination | 7948A2 |
| 1 | 2.4mm male open circuit termination | 7948B2 |
| 1 | 2.4mm female fixed termination | 7931A2 |
| 1 | 2.4mm male fixed termination | 7931B2 |
| 1* | 2.4mm female to 2.4mm female adapter | 7921A1 |
| 1* | 2.4mm male to 2.4mm male adapter | 7921B1 |
| 1* | 2.4mm female to 2.4mm male adapter | 7921C1 |
| 1 | Foam-lined wood Instrument case | — |
| 1 | 5/16-inch torque wrench — 8 in. lbs. | 8799A1 |
| 1 | 5/16-inch double end wrench | 8770Z6 |

* These adapters are provided in the 7950CK41 kits, but are not included in the 7950CK40 kits.

Components Included in 7950CK50/51 Kits

| QUANTITY | DESCRIPTION | MODEL |
|----------|---------------------------------------|--------|
| 1 | 2.4mm female fixed short circuit | 7946A2 |
| 1 | 2.4mm male fixed short circuit | 7946B2 |
| 1 | 2.4mm female open circuit termination | 7948A2 |
| 1 | 2.4mm male open circuit termination | 7948B2 |
| 1 | 2.4mm female fixed termination | 7931A2 |
| 1 | 2.4mm male fixed termination | 7931B2 |
| 1* | 2.4mm female to 2.4mm female adapter | 7921A1 |
| 1* | 2.4mm male to 2.4mm male adapter | 7921B1 |
| 1* | 2.4mm female to 2.4mm male adapter | 7921C1 |
| 1 | Foam-lined wood Instrument case | — |
| 1 | 5/16-inch torque wrench — 8 in. lbs. | 8799A1 |
| 1 | 5/16-inch double end wrench | 8770Z6 |

* These adapters are provided in the 7950CK51 kits, but are not included in the 7950CK50 kits.



DATA SHEET
2Z-072

2.92mm VNA Calibration Kits

8770CK40/41 SERIES, AND
8770CK50/51 SERIES

Features

- > 2.92mm Connectors
- > DC to 40 GHz
- > Compatible with Insight calibration SW and uncertainty analysis*
- > Keysight, Rohde & Schwarz and Anritsu VNAs Supported

Calibration Methods Supported

- > 8770CK40/41 – Fixed Load SOLT (DC–40 GHz)
- > 8770CK50/51 – Characterized Device (CD) SOLT (0.05–40 GHz)

8770CK40



8770CK41



Maury precision 2.92mm VNA calibration kits include each of the calibration standards and tools shown in the tables at the right. The 8770CK40/50 kits do not include adapters; the 8770CK41/51 kits include one each of the in-series adapters shown. Other in-series and between-series adapters are sold separately.

Components Included in 8770CK40/41 Kits

| QUANTITY | DESCRIPTION | MODEL |
|----------|--|--------|
| 1 | 2.92mm female fixed short circuit | 8771F4 |
| 1 | 2.92mm male fixed short circuit | 8772F4 |
| 1 | 2.92mm female open circuit termination | 8773A4 |
| 1 | 2.92mm male open circuit termination | 8773B4 |
| 1 | 2.92mm female fixed termination | 8775A4 |
| 1 | 2.92mm male fixed termination | 8775B4 |
| 1* | 2.92mm female to 2.92mm female adapter | 8714A2 |
| 1* | 2.92mm male to 2.92mm male adapter | 8714B2 |
| 1* | 2.92mm female to 2.92mm male adapter | 8714C2 |
| 1 | Foam-lined wood Instrument case | — |
| 1 | 5/16-inch torque wrench — 8 in. lbs. | 8799A1 |
| 1 | 5/16-inch double end wrench | 8770Z6 |

* These adapters are provided in the 8770CK41 kits, but are not included in the 8770CK40 kits.

Components Included in 8770CK50/51 Kits

| QUANTITY | DESCRIPTION | MODEL |
|----------|--|--------|
| 1 | 2.92mm female fixed short circuit | 8771F4 |
| 1 | 2.92mm male fixed short circuit | 8772F4 |
| 1 | 2.92mm female open circuit termination | 8773A4 |
| 1 | 2.92mm male open circuit termination | 8773B4 |
| 1 | 2.92mm female fixed termination | 8775A4 |
| 1 | 2.92mm male fixed termination | 8775B4 |
| 1* | 2.92mm female to 2.92mm female adapter | 8714A2 |
| 1* | 2.92mm male to 2.92mm male adapter | 8714B2 |
| 1* | 2.92mm female to 2.92mm male adapter | 8714C2 |
| 1 | Foam-lined wood Instrument case | — |
| 1 | 5/16-inch torque wrench — 8 in. lbs. | 8799A1 |
| 1 | 5/16-inch double end wrench | 8770Z6 |

* These adapters are provided in the 8770CK51 kits, but are not included in the 8770CK50 kits.



DATA SHEET
2Z-073

3.5mm VNA Calibration Kits

8050CK40/41 SERIES, AND
8050CK50/51 SERIES

Maury precision 3.5mm VNA calibration kits include each of the calibration standards and tools shown in the tables at the right. The 8050CK40/50 kits do not include adapters; the 8050CK41/51 kits include one each of the in-series adapters shown. Other in-series and between-series adapters are sold separately.

Features

- > 3.5mm Connectors
- > DC to 26.5 GHz
- > Compatible with Insight calibration SW and uncertainty analysis*
- > Keysight, Rohde & Schwarz and Anritsu VNAs Supported

Calibration Methods Supported

- > 8050CK40/41 – Fixed Load SOLT (DC–26.5 GHz)
- > 8050CK50/51 – Characterized Device (CD) SOLT (0.05–26.5 GHz)

8050CK40



8050CK41



Components Included in 8050CK40/41 Kits

| QUANTITY | DESCRIPTION | MODEL |
|----------|---------------------------------------|--------|
| 1 | 3.5mm female fixed short circuit | 8046F6 |
| 1 | 3.5mm male fixed short circuit | 8047F6 |
| 1 | 3.5mm female open circuit termination | 8048A6 |
| 1 | 3.5mm male open circuit termination | 8048B6 |
| 1 | 3.5mm female fixed termination | 8031A6 |
| 1 | 3.5mm male fixed termination | 8031B6 |
| 1* | 3.5mm female to 3.5mm female adapter | 8021A3 |
| 1* | 3.5mm male to 3.5mm male adapter | 8021B3 |
| 1* | 3.5mm female to 3.5mm male adapter | 8021C3 |
| 1 | 5/16-inch torque wrench — 8 in. lbs. | 8799A1 |
| 1 | 7/16-inch double end wrench | 8770Z7 |
| 1 | 5/16-inch double end wrench | 8770Z6 |
| 1 | Foam-lined wood Instrument case | — |

* These adapters are provided in the 8050CK41 kits, but are not included in the 8050CK40 kits.

Components Included in 8050CK50/51 Kits

| QUANTITY | DESCRIPTION | MODEL |
|----------|---------------------------------------|--------|
| 1 | 3.5mm female fixed short circuit | 8046F6 |
| 1 | 3.5mm male fixed short circuit | 8047F6 |
| 1 | 3.5mm female open circuit termination | 8048A6 |
| 1 | 3.5mm male open circuit termination | 8048B6 |
| 1 | 3.5mm female fixed termination | 8031A6 |
| 1 | 3.5mm male fixed termination | 8031B6 |
| 1* | 3.5mm female to 3.5mm female adapter | 8021A3 |
| 1* | 3.5mm male to 3.5mm male adapter | 8021B3 |
| 1* | 3.5mm female to 3.5mm male adapter | 8021C3 |
| 1 | 5/16-inch torque wrench — 8 in. lbs. | 8799A1 |
| 1 | 7/16-inch double end wrench | 8770Z7 |
| 1 | 5/16-inch double end wrench | 8770Z6 |
| 1 | Foam-lined wood Instrument case | — |

* These adapters are provided in the 8050CK51 kits, but are not included in the 8050CK50 kits.



DATA SHEET
2Z-074

7mm VNA Calibration Kits

MODELS 2650CK40 AND
2650CK50

Maury precision 7mm VNA calibration kits include each of the calibration standards and tools shown in the tables at the right. The 2650CK40/50 kits do not include adapters; in-series and between-series adapters are sold separately.

Features

- > 7mm Connectors
- > DC to 18 GHz
- > Compatible with Insight calibration SW and uncertainty analysis*
- > Keysight, Rohde & Schwarz and Anritsu VNAs Supported

Calibration Methods Supported

- > 2650CK40 – Fixed Load SOLT (DC–18.0 GHz)
- > 2650CK50 – Characterized Device (CD) SOLT (0.05–18.0 GHz)

2650CK40



2650CK50



Components Included in 2650CK40 Kits

| QUANTITY | DESCRIPTION | MODEL |
|----------|--------------------------------------|--------|
| 1 | 7mm fixed short circuit | 2615D3 |
| 1 | 7mm open circuit termination | 2616F1 |
| 1 | 7mm fixed termination | 2610F1 |
| 1 | 3/4-inch torque wrench — 12 in. lbs. | 2698C2 |
| 1 | Foam-lined wood Instrument case | — |

Components Included in 2650CK50 Kits

| QUANTITY | DESCRIPTION | MODEL |
|----------|--------------------------------------|--------|
| 1 | 7mm fixed short circuit | 2615D3 |
| 1 | 7mm open circuit termination | 2616F1 |
| 1 | 7mm fixed termination | 2610F1 |
| 1 | 3/4-inch torque wrench — 12 in. lbs. | 2698C2 |
| 1 | Foam-lined wood Instrument case | — |

Type N VNA Calibration Kits

8850CK40/41 SERIES AND
8850CK50/51 SERIES

Maury precision Type N VNA calibration kits include each of the calibration standards and tools shown in the tables at the right. The 8850CK40/50 kits do not include adapters; the 8850CK41/51 kits include one each of the in-series adapters shown. Other in-series and between-series adapters are sold separately.

Features

- > Type N Connectors
- > DC to 18 GHz
- > Compatible with Insight calibration SW and uncertainty analysis*
- > Keysight, Rohde & Schwarz and Anritsu VNAs Supported

Calibration Methods Supported

- > 8850CK40/41 – Fixed Load SOLT (DC–18.0 GHz)
- > 8850CK50/51 – characterized Device (CD) SOLT (0.05–18.0 GHz)

8850CK40



8850CK41



Components Included in 8850CK40/41 Kits

| QUANTITY | DESCRIPTION | MODEL |
|----------|--|--------|
| 1 | Type N female fixed short circuit | 8806G2 |
| 1 | Type N male fixed short circuit | 8807C2 |
| 1 | Type N female open circuit termination | 8809B2 |
| 1 | Type N male open circuit termination | 8810B2 |
| 1 | Type N female fixed termination | 2510E2 |
| 1 | Type N male fixed termination | 2510F2 |
| 1* | Type N female to Type N female adapter | 8828A2 |
| 1* | Type N male to Type N male adapter | 8828B2 |
| 1* | Type N female to Type N male adapter | 8828C2 |
| 1 | 3/4-inch torque wrench — 12.0 in. lbs. | 2698C2 |
| 1 | Foam-lined wood Instrument case | — |
| 1 | 1/2 - 9/16 inch end wrench | 2517S3 |

* These adapters are provided in the 8850CK41 kits, but are not included in the 8850CK40 kits.

Components Included in 8850CK50/51 Kits

| QUANTITY | DESCRIPTION | MODEL |
|----------|--|--------|
| 1 | Type N female fixed short circuit | 8806G2 |
| 1 | Type N male fixed short circuit | 8807C2 |
| 1 | Type N female open circuit termination | 8809B2 |
| 1 | Type N male open circuit termination | 8810B2 |
| 1 | Type N female fixed termination | 2510E2 |
| 1 | Type N male fixed termination | 2510F2 |
| 1* | Type N female to Type N female adapter | 8828A2 |
| 1* | Type N male to Type N male adapter | 8828B2 |
| 1* | Type N female to Type N male adapter | 8828C2 |
| 1 | 3/4-inch torque wrench — 12.0 in. lbs. | 2698C2 |
| 1 | Foam-lined wood Instrument case | — |
| 1 | 1/2 - 9/16 inch end wrench | 2517S3 |

* These adapters are provided in the 8850CK51 kits, but are not included in the 8850CK50 kits.



DATA SHEET
2Z-076

75Ω Type N VNA Calibration Kits

888040/41 SERIES

Features

- > 75Ω Type N Connectors
- > DC to 18 GHz
- > Simple Fixed Load Calibration
- > Keysight, Rohde & Schwarz and Anritsu VNAs Supported

Calibration Methods Supported

- > 8880CK40/41 – Fixed Load SOLT (DC–18 GHz)

8880CK40



8880CK41



Maury precision 75Ω Type N VNA calibration kits include each of the calibration standards shown in the tables below. The 8880CK40 kits do not include adapters; the 8880CK41 kits include one each of the in-series adapters shown.

Components Included in 8880CK40 Kits

| QUANTITY | DESCRIPTION | MODEL |
|----------|---------------------------------------|--------|
| 1 | 75Ω Type N female fixed short circuit | 8884A1 |
| 1 | 75Ω Type N male fixed short circuit | 8884B1 |
| 1 | 75Ω Type N female open circuit | 8885A1 |
| 1 | 75Ω Type N male open circuit | 8885B1 |
| 1 | 75Ω Type N female fixed termination | 8883A1 |
| 1 | 75Ω Type N male fixed termination | 8883B1 |
| 1 | Foam-lined wood Instrument case | — |

Components Included in 8880CK41 Kits

| QUANTITY | DESCRIPTION | MODEL |
|----------|--|--------|
| 1 | 75Ω Type N female fixed short circuit | 8884A1 |
| 1 | 75Ω Type N male fixed short circuit | 8884B1 |
| 1 | 75Ω Type N female open circuit | 8885A1 |
| 1 | 75Ω Type N male open circuit | 8885B1 |
| 1 | 75Ω Type N female fixed termination | 8883A1 |
| 1 | 75Ω Type N male fixed termination | 8883B1 |
| 1* | 75Ω Type N female to 75Ω Type N female adapter | 8882A1 |
| 1* | 75Ω Type N male to 75Ω Type N male adapter | 8882B1 |
| 1* | 75Ω Type N female to 75Ω Type N male adapter | 8882C1 |
| 1 | Foam-lined wood Instrument case | — |

* These adapters are provided in the 8880CK41 kits, but are not included in the 8880CK40 kits.



DATA SHEET
2Z-061A

TNC VNA Calibration Kits

MODELS 8650CK10/11 AND 8650CK20/21

Features

- > TNC Connectors
- > DC to 18 GHz
- > High Performance
- > Keysight, Rohde & Schwarz and Anritsu VNAs Supported

Calibration Methods Supported

- > 8650CK10 & 8650CK11 – Fixed Load SOLT (DC–18.0 GHz)
- > 8650CK20 & 8650CK21 – Sliding/ Fixed Load SOLT (DC–18.0 GHz)

8650CK10



8650CK11



Maury precision TNC VNA calibration kits include each of the calibration standards and tools shown in the tables at the right. The 8650CK10/20 kits do not include adapters; the 8650CK11/21 kits include one each of the in-series adapters shown. Other in-series and between-series adapters are sold separately.

Components Included in 8650CK10/11 Kits

| QUANTITY | DESCRIPTION | MODEL |
|----------|----------------------------------|--------|
| 1 | TNC female fixed short circuit | 8615A |
| 1 | TNC male fixed short circuit | 8615B |
| 1 | TNC female open circuit | 8609B |
| 1 | TNC male open circuit | 8610B |
| 1 | TNC female fixed termination | 332E |
| 1 | TNC male fixed termination | 332F |
| 1* | TNC female to TNC female adapter | 232A11 |
| 1* | TNC male to TNC male adapter | 232B11 |
| 1* | TNC female to TNC male adapter | 232C11 |
| 1 | Foam-lined wood instrument case | — |

* These adapters are provided in the 8650CK11 kits, but are not included in the 8650CK10 kits.

Components Included in 8650CK20/21 Kits

| QUANTITY | DESCRIPTION | MODEL |
|----------|---------------------------------------|--------|
| 1 | TNC female fixed short circuit | 8615A |
| 1 | TNC male fixed short circuit | 8615B |
| 1 | TNC female open circuit | 8609B |
| 1 | TNC male open circuit | 8610B |
| 1 | TNC female fixed termination | 332E |
| 1 | TNC male fixed termination | 332F |
| 1* | TNC female to TNC female adapter | 232A11 |
| 1* | TNC male to TNC male adapter | 232B11 |
| 1* | TNC female to TNC male adapter | 232C11 |
| 1 | TNC female sliding termination | 452A1 |
| 1 | TNC male sliding termination | 452B1 |
| 1 | 9/16-inch torque wrench — 12 in. lbs. | 2698G1 |
| 1 | 7/16-inch open end wrench | 8770Z7 |
| 1 | Foam-lined wood instrument case | — |

* These adapters are provided in the 8650CK21 kits, but are not included in the 8650CK20 kits.



DATA SHEET
2Z-062

AFTNC VNA Calibration Kits

MODELS 8680CK10/11 AND 8680CK20/21

Features

- > AFTNC Connectors
- > DC to 20 GHz
- > High Performance
- > Keysight, Rohde & Schwarz and Anritsu VNAs Supported

Calibration Methods Supported

- > 8680CK10 & 8680CK11 – Fixed Load SOLT (DC–20.0 GHz)
- > 8680CK20 & 8680CK21 – Sliding/Fixed Load SOLT (DC–20.0 GHz)

8680CK10



8680CK11



Maury precision AFTNC VNA calibration kits include each of the calibration standards and tools shown in the tables at the right. The 8680CK10/20 kits do not include adapters; the 8680CK11/21 kits include one each of the in-series adapters shown. Other in-series and between-series adapters are sold separately.

Components Included in 8680CK10/11 Kits

| QUANTITY | DESCRIPTION | MODEL |
|----------|--------------------------------------|-------|
| 1 | AFTNC female fixed short circuit | 8686A |
| 1 | AFTNC male fixed short circuit | 8687A |
| 1 | AFTNC female open circuit | 8685A |
| 1 | AFTNC male open circuit | 8685B |
| 1 | AFTNC female fixed termination | 8684A |
| 1 | AFTNC male fixed termination | 8684B |
| 1* | AFTNC female to AFTNC female adapter | 8688A |
| 1* | AFTNC male to AFTNC male adapter | 8688B |
| 1* | AFTNC female to AFTNC male adapter | 8688C |
| 1 | Foam-lined wood instrument case | — |

* These adapters are provided in the 8680CK11 kits, but are not included in the 8680CK10 kits.

Components Included in 8680CK20/21 Kits

| QUANTITY | DESCRIPTION | MODEL |
|----------|---------------------------------------|--------|
| 1 | AFTNC female fixed short circuit | 8686A |
| 1 | AFTNC male fixed short circuit | 8687A |
| 1 | AFTNC female open circuit | 8685A |
| 1 | AFTNC male open circuit | 8685B |
| 1 | AFTNC female fixed termination | 8684A |
| 1 | AFTNC male fixed termination | 8684B |
| 1* | AFTNC female to AFTNC female adapter | 8688A |
| 1* | AFTNC male to AFTNC male adapter | 8688B |
| 1* | AFTNC female to AFTNC male adapter | 8688C |
| 1 | AFTNC female sliding termination | 8683A |
| 1 | AFTNC male sliding termination | 8683B |
| 1 | 9/16-inch torque wrench — 12 in. lbs. | 2698G1 |
| 1 | 7/16-inch open end wrench | 8770Z7 |
| 1 | Foam-lined wood instrument case | — |

* These adapters are provided in the 8680CK21 kits, but are not included in the 8680CK20 kits.



DATA SHEET
2Z-062A

BNC VNA Calibration Kits

8550CK10 & 8580CK10 MODELS

Features

- > 50Ω or 75Ω BNC Connectors
- > DC to 10.0 GHz & DC to 12.0 GHz
- > Simple Fixed Load Calibration
- > Keysight, Rohde & Schwarz and Anritsu VNAs Supported

Calibration Methods Supported

- > 8550CK10 (50Ω) – Fixed Load SOLT (DC–10.0 GHz)
- > 8580CK10 (75Ω) – Fixed Load SOLT (DC–12.0 GHz)

8550CK10



8580CK10



Maury precision BNC VNA calibration kits include each of the calibration standards and tools shown in the tables at the right. Between-series adapters are sold separately.

Components Included in 8550CK10 Kits

| QUANTITY | DESCRIPTION | MODEL |
|----------|------------------------------------|-------|
| 1 | 50Ω BNC female fixed short circuit | 361N2 |
| 1 | 50Ω BNC male fixed short circuit | 361P2 |
| 1 | 50Ω BNC female open circuit | 371N2 |
| 1 | 50Ω BNC male open circuit | 371P2 |
| 1 | 50Ω BNC female fixed termination | 351A2 |
| 1 | 50Ω BNC male fixed termination | 351B2 |
| 1 | Foam-lined wood instrument case | — |

Between series adapters are available by separate order. Go to maurymw.com for more information.

Components Included in 8580CK10 Kits

| QUANTITY | DESCRIPTION | MODEL |
|----------|------------------------------------|--------|
| 1 | 75Ω BNC female fixed short circuit | 8584A1 |
| 1 | 75Ω BNC male fixed short circuit | 8584B1 |
| 1 | 75Ω BNC female open circuit | 8585A1 |
| 1 | 75Ω BNC male open circuit | 8585B1 |
| 1 | 75Ω BNC female fixed termination | 8583A1 |
| 1 | 75Ω BNC male fixed termination | 8583B1 |
| 1 | Foam-lined wood instrument case | — |

Between series adapters are available by separate order. Go to maurymw.com for more information.



DATA SHEET
2Z-069

Waveguide VNA Calibration Kits

CK10/12 & CK30/32 MODELS



Features

- > 2.6 to 50 GHz
- > WR284 Through WR22
- > SSLT and TRL calibration
- > Keysight, Rohde & Schwarz and Anritsu VNAs Supported

Components Included in CK10/12 Kits

| Qty | Description | Model |
|-----|--|----------------|
| 1** | Fixed flush (reference plane) short | 344 series |
| 1 | 1/8-λ fixed offset short | 340 series |
| 1 | 3/8-λ fixed offset short | 340 series |
| 1 | Precision fixed termination | 301 series |
| 1** | Straight section (rectangular) | 102/3/6 series |
| 1* | 3/32-in. hex ball driver * | J998T2 |
| 1 | Flange hardware (including the indexing pin set) | — |
| 1 | Instrument case | — |

Components Included in CK30/32 Kits

| Qty | Description | Model |
|-----|--|----------------|
| 1 | Fixed flush (reference plane) short | 344 series |
| 1 | 1/4-λ straight section (shim) | 322 series |
| 1 | Precision fixed termination | 301 series |
| 1** | Straight section (rectangular) | 102/3/6 series |
| 1* | 3/32-in. hex ball driver * | J998T2 |
| 1 | Flange hardware (including the indexing pin set) | — |
| 1 | Instrument case | — |

* Included in the K, Q, U and J band kits only.

** Included in CK12/32 kits.

The Importance of VNA Calibration

Any uncalibrated test setup has systematic errors inherent in the equipment used. The ability to obtain an accurate measurement of a device under test. The basis of network analyzer error correction is the measurement of known electrical standards, such as a thru, open circuit, short circuit, and precision load impedance. By calibrating your network analyzer with these standards, you can compensate for the inherent imperfections.

Description

CK10/12 - The CK10/12 SSLT Waveguide Calibration Kits are designed to provide accurate calibration of vector network analyzers (VNAs) that are used for measurements in standard rectangular waveguide from 2.6 to 50 GHz (WR284–WR22). Each kit includes all the components needed for accurate calibration of most VNAs to ensure high effective directivity after calibration.

CK30/32 - Maury CK30/32 calibration kits are designed to provide accurate Thru-Reflect-Line (TRL), Short-Short-Load-Thru (SSLT) and Offset Load calibrations of vector network analyzers (VNAs) for measurements in rectangular waveguide from 2.6 to 50 GHz (WR284 to WR22). Each kit includes all the components needed for accurate TRL, SSLT or Offset Load calibration of supported VNA models.

**Precision straight sections and a fixed (reference plane) short are also provide as verification standards in the CK12 or CK32 options.*

Flange Description

The components in these kits are equipped with Maury Precision Flanges (MPF) which conform to EIA WR standards for rectangular or round waveguide flanges. MPF flanges have precision indexing holes and corresponding indexing pins for precise alignment when mating, which ensures excellent measurement repeatability. Flange diagrams and other details can be found at <http://www.maurymw.com>. (Use the search feature with search term “MPF”.)

Calibration Methods

CK10/12 - These kits are configured for use in performing one-port SSL (Short-Short-Load) calibrations for measuring VSWR/Return Loss, or full two-port SSLT (Short-Short-Load-Thru) calibrations to perform forward and reverse transmission and reflection measurements.

CK30/32 - These kits are configured for use in performing full two-port TRL (Thru-Reflect-Line) and SSLT (Short-Short-Load-Thru) calibrations; two standard methods for measuring forward and reverse transmission and reflection measurements). They can also be used to perform Offset Load calibrations on VNAs that support that calibration method.



DATA SHEET
3H-081

Component Specifications

CK10/12 SSLT & CK30/32 TRL Kits

Fixed Flush Shorts – Model Series 344

These machined fixed shorts are flat-face/flat-plane shorts designed to terminate round or rectangular waveguide connectors at the mating plane, over a frequency range from 2.6 to 50 GHz. They are used to establish a reference plane in systems and in making loss measurements.

1/8λ & 3/8λ Fixed Offset Shorts – Model Series 340

These fixed offset shorts are considered one of the more accurate means of obtaining a 180° phase difference in waveguide. Using these single-piece devices reduces the number of flange interfaces during calibration; helping to maintain an essentially constant magnitude of current flow across the calibration plane. Those in rectangular waveguide are nominally 1/8λ and 3/8λ offset at frequencies near the waveguide band centers. These frequencies are chosen to equalize phase differences at band edges, and thus are not at the exact band centers.

Offset delay ranges from 50.835 – 4.007 ps for the 1/8λ shorts and 152.506 – 12.002 for the 3/8λ shorts; calculated without consideration for the dispersive effect of waveguide if the short is in air dielectric coaxial line. This conforms to the convention established for Agilent network analyzers. Anritsu analyzers use the actual mechanical offset in centimeters.

1/4λ Precision Straight Sections – Model Series 322B

These 322B series 1/4λ straight sections are reduced height spacers or shims which provide an accurately known VSWR which is directly calculable from their mechanical dimensions. The shims are designed for a theoretical VSWR of 1.00. The shims are fabricated from aluminum and are provided with precision indexing holes for excellent flange alignment. Their simple geometry allows direct calculation of reflection, loss, transfer and group delay characteristics and makes them ideally suited for quickly checking the performance and accuracy of automated network analyzers.

Precision Fixed Terminations – Model Series 301

These low power fixed terminations feature low VSWR (1.025 – 1.040 max up to 50.0 GHz; typically <1.02 from 3.95 to 18.0 GHz). Power handling is rated from 25W (avg)/10kW (peak) to 0.2W (avg)/0.03kW (peak) depending on frequency range.

Verification Stds – Precision Straight Sections

These precision straight sections exhibit low VSWR (1.025 max) across the frequency range of operation. These precision stds can be used along with the fixed flush shorts as verification stds to validate accuracy of calibration.

Available Models

| Waveguide Designation (EIA WR NO.) | FREQUENCY RANGE (GHz) | MMC WAVEGUIDE BAND | SSLT CALIBRATION KIT | SSLT CALIBRATION KIT w/ VERIFICATION STD. | TRL CALIBRATION KIT | TRL CALIBRATION KIT w/ VERIFICATION STD. | FLANGE DESIGN |
|------------------------------------|-----------------------|--------------------|----------------------|---|---------------------|--|---------------|
| WR284 | 2.60 - 3.95 | S | WR284CK10 | WR284CK12 | WR284CK30 | WR284CK32 | MPF284C |
| WR229 | 3.30 - 4.90 | E | WR229CK10 | WR229CK12 | WR229CK30 | WR229CK32 | MPF229B |
| WR187 | 3.95 - 5.85 | G | WR187CK10 | WR187CK12 | WR187CK30 | WR187CK32 | MPF187C |
| WR159 | 4.90 - 7.05 | F | WR159CK10 | WR159CK12 | WR159CK30 | WR159CK32 | MPF159B |
| WR137 | 5.85 - 8.20 | C | WR137CK10 | WR137CK12 | WR137CK30 | WR137CK32 | MPF137C |
| WR112 | 7.05 - 10.0 | H | WR112CK10 | WR112CK12 | WR112CK30 | WR112CK32 | MPF112B |
| WR90 | 8.20 - 12.4 | X | WR90CK10 | WR90CK12 | WR90CK30 | WR90CK32 | MPF90C |
| WR75 | 10.0 - 15.0 | M | WR75CK10 | WR75CK12 | WR75CK30 | WR75CK32 | MPF75B |
| WR62 | 12.4 - 18.0 | P | WR62CK10 | WR62CK12 | WR62CK30 | WR62CK32 | MPF62 |
| WR51 | 15.0 - 22.0 | N | WR51CK10 | WR51CK12 | WR51CK30 | WR51CK32 | MPF51B |
| WR42 | 18.0 - 26.5 | K | WR42CK10 | WR42CK12 | WR42CK30 | WR42CK32 | MPF42 |
| WR34 | 22.0 - 33.0 | Q | — | — | WR34CK30 | WR34CK32 | MPF34 |
| WR28 | 26.5 - 40.0 | U | WR28CK10 | WR28CK12 | WR28CK30 | WR28CK32 | MPF28 |
| WR22 | 33.0 - 50.0 | J | WR22CK10 | WR22CK12 | WR22CK30 | WR22CK32 | MPF22 |

Verification Kits



The Importance of VNA Calibration Validation

VNA calibration is performed to correct for the systematic imperfections which existing in all network analyzers and allow for users to shift the reference plane from the instrument test ports to a user-defined reference plane. However, how can one be sure that the calibration performed will result in accurate measurements?

Validation is by far the most important step in a measurement process. Conventional validation techniques rely on an estimate of the residual errors after a calibration, source match, directivity and tracking, and are typically evaluated by measuring peak-to-peak ripple through a TDR method. These techniques rely on an airline as the validation standard, and the accuracy of the validation can be severely impacted by how well the airline has been machined and handled.

Maury's new line of Verification Kits allows for a more thorough and definitive validation.

VNA Validation Methods

Maury Verification Kits consist of the following verification standards and allow for 1-port and 2-port calibration validation for well-matched and mismatched DUTs:

- > Loads (Male and Female)
- > Offset Short (Male and Female)
- > Beaded Airline (Male to Female)
- > Beaded Mismatch (Male to Female)

These standard can be used to validate the calibration using one of the following methods:

Method 1- S parameters comparison of User-Characterized and Factory-Characterized Verification Standards

This method involves a user measuring pre-characterized verification devices with similar performances to their own device; i.e. using a short as a validation of a high-reflection single-port device, or an airline for well-matched low-loss devices. The measurement data is then compared to the factory-measured data and the user determines whether the calibration is valid or not, based on experience or general guidelines. There is no clear pass-fail criteria that quantifies whether a calibration is sufficiently accurate to proceed to device measurement, or whether a calibration needs to be repeated.

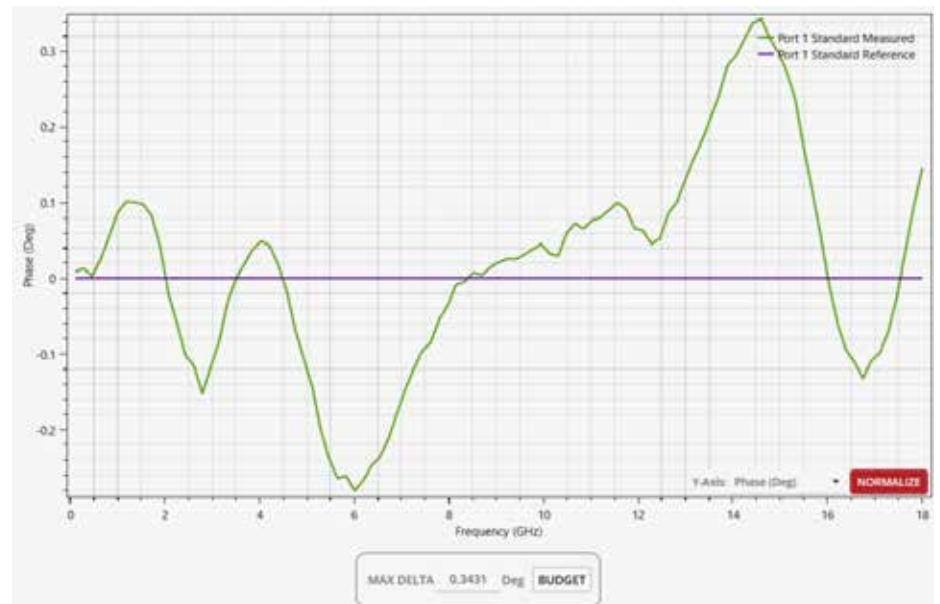

Figure 1. Normalized phase response between user-measured and factory-measured standard



DATA SHEET
2Z-077

Method 2 – S-parameters Comparison of User-Characterized and Factory-Characterized Verification Standards including Measured Uncertainty Boundaries

It is possible to define clear pass-fail criteria based on the use of uncertainty boundaries. When the uncertainty boundaries measured on a verification device by the user overlaps the uncertainty boundaries measured on the same verification device at the factory, it is defined as an accurate calibration. If the boundaries do not overlap, then recalibration is recommended. Maury offers a VNA Calibration and Measurement software suite, Insight, which among other things automates this process by guiding users through the calibration validation and clearly identifies whether the calibration can be used or must be repeated. For more information on Insight, please visit maurymw.com.

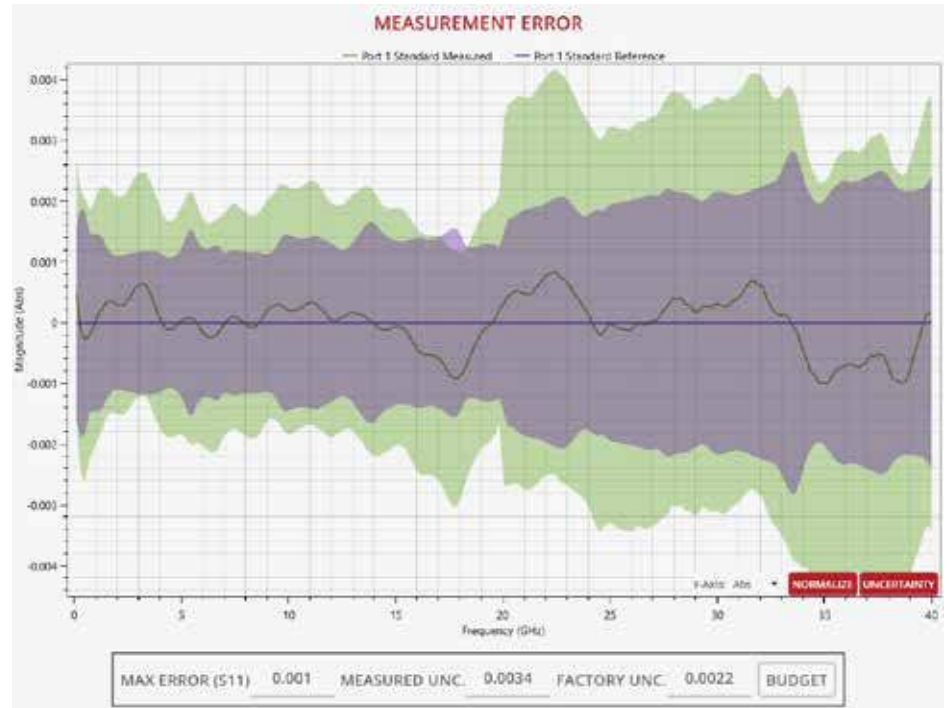

Figure 2. Normalized amplitude response between user-characterized and factory-characterized standard including uncertainty boundaries.

Recommended Accessories

Insight Calibration and Measurement Software:

Insight is the industry's first commercial software suite designed to empower VNA users and help them make better decisions by quantifying measurement uncertainty. Insight is an agnostic software tool compatible with most commercial VNAs and represents a paradigm shift in the way users approach VNA calibration, validation, measurement, visualization and analysis. More information regarding Insight can be found in data sheet [4T-023](#).

VNA Calibration Kits:

Maury offers coaxial VNA calibration kits up to 67 GHz and waveguide calibration kits up to 50 GHz in standard connector and waveguide sizes. Coaxial 2.4mm, 2.92mm, 3.5mm, 7mm and Type N calibration kits are available as fixed-load SOLT kits with either standard polynomial equations or characterized device (CD) with individually characterized standards. More information can be found in data sheets [2Z-056 \(1.85mm\)](#), [2Z-072 \(2.4mm\)](#), [2Z-073 \(2.92mm\)](#), [2Z-074 \(3.5mm\)](#), [2Z-075 \(7mm\)](#), and [2Z-076 \(Type N\)](#), [2Z-062 \(TNC\)](#), [2Z-069 \(BNC\)](#) and [3H-081 \(WR284 Through WR22\)](#).

Available Models

| Model | Connector | Frequency (GHz) | Included Verification Standards | | | | | |
|----------|-----------|-----------------|---------------------------------|---------------|---------------------|-----------------------|----------------|------------------|
| | | | Load (male) | Load (female) | Offset Short (male) | Offset Short (female) | Beaded Airline | Mismatch Airline |
| 7950CK60 | 2.4mm | 0.05-50 | 7931B2 | 7913A2 | 7946D2 | 7946C2 | 7942C | 7942C25 |
| 8770CK60 | 2.92mm | 0.05-40 | 8775B4 | 8775A4 | 8772A2 | 8771A2 | 8776C | 8776C75 |
| 8050CK60 | 3.5mm | 0.05-26.5 | 8031B6 | 8031A6 | 8047A6 | 8046A6 | 8042C1 | 8042C25 |
| 2650CK60 | 7mm | 0.05-18 | 2610F1 | | 2649A1 | | 2603F1 | 2603F75 |
| 8850CK60 | Type N | 0.05-18 | 2510F2 | 2510E2 | 8807A2 | 8806A2 | 2503H | 2503H75 |

7950CK60



8770CK60



8050CK60



2650CK60



8850CK60



Precision Fixed Terminations

GENERAL INFORMATION



Fixed Terminations

A precision fixed termination (or load) consists of an immovable, (fixed) termination which, when mated to the end of a transmission line or cable, absorbs nearly all of the signal energy traveling toward it. An ideal “matched” condition exists when a termination with an impedance value of Z_0 , is connected to the end of a transmission line or cable that also has a characteristic impedance of Z_0 . Such an ideal “matched” condition (one with no mismatch between the termination and its mated line or cable) is critical if a voltage standing wave ratio (VSWR) of 1.0:1 is to be achieved in a system with a 50 or 75 ohm impedance value. Simply put, the more closely the 1.0:1 ratio is approached, the more accurate the measurements that can be made from a system.

Maury precision fixed terminations are designed to exacting specifications and are as close to the ideal impedance as it is mechanically possible to make them. The following pages provide detailed information about the various types of precision fixed terminations offered by Maury. Most are normally sold as components of Maury VNA calibration kits, but may also be purchased separately as replacement parts or spares.

Precision Fixed Terminations Available Models

| Model | Sex | Connector Type | Frequency Range (GHz) | VSWR | Power Rating |
|--------|--------|----------------|--|----------------------|-----------------------------|
| 7831A1 | Female | 1.85mm | DC – 1.0 | 1.02 | 0.5 watt CW 0.25 kW peak |
| 7831B1 | Male | | 1.0 – 10.0 10.0 – 26.5 26.5 – 67.0 | 1.07 1.10 1.20 | |
| 7931A2 | Female | 2.4mm | DC – 4.0 | 1.02 | 0.5 watt CW 0.25 kW peak |
| 7931B2 | Male | | 4.0 – 50.0 | 1.16 | |
| 8775A4 | Female | 2.92mm | DC – 4.0 | 1.02 | 0.5 watt CW 0.25 kW peak |
| 8775B4 | Male | | 4.0 – 40.0 | 1.12 | |
| 8031A6 | Female | 3.5mm | DC – 2.0 | 1.025 | 0.5 watt CW 0.25 kW peak |
| 8031B6 | Male | | 2.0 – 18.0 18.0 – 26.5 | 1.045 1.085 | |
| 2610F1 | – | 7mm | DC – 2.0 2.0 – 8.0 8.0 – 18.0 | 1.02 1.03 1.06 | 1 watt CW 1 kW peak |
| 2510E2 | Female | Type N | DC – 2.0 | 1.025 | 1 watt CW 1 kW peak |
| 2510F2 | Male | | 2.0 – 4.0 4.0 – 18.0 | 1.04 1.065 | |
| 8583A1 | Female | BNC 75Ω | DC – 2.0 | 1.02 | 1 watt CW |
| 8583B1 | Male | | 2.0 – 4.0 4.0 – 12.0 | 1.04 1.10 | |
| 351A2 | Female | BNC 50Ω | DC – 2.0 | 1.04 | 2 watt CW 1 kW peak |
| 351B2 | Male | | 2.0 – 4.0 4.0 – 10.0 | 1.10 1.20 | |
| 332E | Female | TNC | DC – 4.0 | 1.06 | 1 watt CW 1 kW peak |
| 332F | Male | | 4.0 – 12.0 12.0 – 18.0 | 1.10 1.15 | |

Precision Fixed Terminations

WAVEGUIDE (301 SERIES)

Features

- > Low VSWR
- > 2.6 to 50 GHz
- > Moderate Power Handling

Description

The 301 series low power waveguide fixed terminations are precision, low VSWR terminations suited to a wide variety of general purpose and precision laboratory applications. They can be used for full band one-port calibration and full two-port, isolation calibration.

Waveguide Flange Description

The waveguide flanges used on these terminations are Maury Precision Flanges (MPF) in rectangular, or round configurations. MPF flanges have precision indexing holes and removable indexing pins for excellent measurement repeatability. The millimeter waveguide

flanges in the WR22 and smaller sizes are of a unique Maury-pioneered design featuring a raised outer rim to prevent the flanges from cocking during connection. These flanges will mate with corresponding UG ()/U flanges. (See page 133 for flange details.)

G301

S301A

K301

Available Models

| MODEL | FREQUENCY RANGE (GHz) | | | VSWR (Maximum) | EIA WR NUMBER | EQUIVALENT FLANGE | POWER RATING | | LENGTH | |
|-------|-----------------------|---|-------|----------------|---------------|--------------------|--------------|-----------|--------|--------|
| | | | | | | | AVE. (W) | PEAK (kW) | inches | (cm) |
| S301A | 2.60 | — | 3.95 | 1.025 | 284 | UG584/U | 5.0 | 2.0 | 10.4 | (26.4) |
| E301F | 3.30 | — | 4.90 | 1.020 | 229 | CPR229F | 5.0 | 2.0 | 7.4 | (18.8) |
| G301 | 3.95 | — | 5.85 | 1.020 | 187 | UG149A/U | 5.0 | 2.0 | 6.4 | (16.3) |
| F301C | 4.90 | — | 7.05 | 1.020 | 159 | CPR159F | 3.0 | 1.0 | 5.8 | (14.7) |
| C301 | 5.85 | — | 8.20 | 1.020 | 137 | UG344/U | 2.5 | 1.0 | 5.2 | (13.2) |
| H301A | 7.05 | — | 10.00 | 1.015 | 112 | UG51/U | 2.0 | 1.0 | 5.0 | (12.7) |
| X301A | 8.20 | — | 12.40 | 1.015 | 90 | UG39/U | 1.0 | 1.0 | 5.0 | (12.7) |
| M301A | 10.00 | — | 15.00 | 1.020 | 75 | MPF75 | 1.0 | 1.0 | 5.0 | (12.7) |
| P301A | 12.40 | — | 18.00 | 1.020 | 62 | UG419/U | 1.0 | 1.0 | 4.0 | (10.2) |
| N301 | 15.00 | — | 22.00 | 1.025 | 51 | MPF51 | 0.5 | 0.2 | 3.1 | (7.9) |
| K301 | 18.00 | — | 26.50 | 1.025 | 42 | UG595/U | 0.5 | 0.2 | 2.8 | (7.1) |
| Q301A | 22.00 | — | 33.00 | 1.025 | 34 | UG1530/U | 0.5 | 0.2 | 4.25 | (10.8) |
| U301 | 26.50 | — | 40.00 | 1.025 | 28 | UG599/U | 0.5 | 0.2 | 2.2 | (5.6) |
| J301A | 33.00 | — | 50.00 | 1.040 | 22 | UG383 ¹ | 0.5 | 0.1 | 1.6 | (4.1) |

¹ Units are supplied with Maury precision flanges (MPF) which mate with the UG flanges shown.

Fixed Flush and Fixed Offset Shorts

GENERAL INFORMATION



Fixed flush and fixed offset short circuit terminations (shorts) are used to establish reference planes in transmission systems and as key elements in the calibration of vector network analyzers (VNAs). Offset shorts can be used for banded calibrations of VNA. Those with the longest offset are often used to evaluate the calibration effectiveness of a VNA by measuring the effective source match after calibration.

In general, the shorting plane of fixed flush shorts is at the connector reference plane, and at some predetermined offset in offset shorts.

Many of the shorts listed in this section are components of the Maury VNA calibration kits described on pages 106-115 of this catalog. Others are available as supplements to the components in these kits. In all cases, the specification “Phase Accuracy” is defined in this section as phase deviation from a nominal unit.

Available Models

| Model | Sex | Connector Type | Frequency Range (GHz) | Phase Accuracy | Reflection Coefficient | Offset Length (Inches) |
|--------|--------|----------------|-----------------------|----------------|------------------------|------------------------|
| 7846A | Female | 1.85mm | DC — 67.0 | ± 4.0° | 0.98 | 0.1968 |
| 7847A | Male | | | | | |
| 7946A2 | Female | 2.4mm | DC — 50.0 | ± 2.0° | 0.98 | 0.2000 |
| 7946B2 | Male | | | N/A | | |
| 7946C2 | Female | | | | 1.2000 | |
| 7946D2 | Male | | | | | |
| 8771F4 | Female | 2.92mm | DC — 40.0 | ± 2.0° | 0.98 | 0.1970 |
| 8772F4 | Male | | | N/A | | |
| 8771A2 | Female | | | | 1.1803 | |
| 8772A2 | Male | | | | | |
| 8046F6 | Female | 3.5mm | DC — 26.5 | ± 2.0° | 0.98 | 0.1970 |
| 8047F6 | Male | | | N/A | | |
| 8046A6 | Female | | | | 1.1803 | |
| 8047A6 | Male | | | | | |
| 360D | Female | 3.5mm\SMA* | DC — 40.0 | ± 2.0° | 0.99 | 0.0000 |
| 360B | Male | | | | | |
| 2615D3 | - | 7mm | DC — 18.0 | ± 0.3° | 0.995 | 0.0000 |
| 2649A1 | - | | | N/A | | |
| 8806G2 | Female | Type N | DC - 18.0 | ± 2.0° | 0.98 | 0.4972 |
| 8807C2 | Male | | | N/A | | |
| 8806A2 | Female | | | | 1.1913 | |
| 8807A2 | Male | | | | | |
| 8584A1 | Female | BNC 75Ω | DC — 2.0 | ± 1.0° | 0.98 | 0.3937 |
| 8584B1 | Male | | 2.0 — 3.0 | ± 2.0° | | |
| | | | 3.0 — 12.0 | ± 6.0° | | |
| 361N2 | Female | BNC 50Ω | DC — 12.4 | ± 5.0° | 0.98 | 0.1410 |
| 361P2 | Male | | | | | |
| 8615A | Female | TNC | DC — 18.0 | ± 5.0° | 0.98 | 0.5000 |
| 8615B | Male | | | | | 0.7000 |
| 8686A | Female | AFTNC | DC — 20.0 | ± 2.0° | 0.98 | 0.9833 |
| 8687A | Male | | | | | 0.4915 |

* Flush shorts that can be used with SMA, 3.5mm and 2.92mm

Waveguide Fixed Flush Shorts

MODEL SERIES 344

Description

These machined fixed shorts are designed to terminate round or rectangular waveguide connectors at the mating plane. They are used to establish a reference plane in systems and in making loss measurements. They are flat face/flat plane shorts that cover frequencies from 2.6 to 50.0 GHz. They may be ordered with user-specified flanges; with or without Maury precision indexing holes. These shorts are included as components of Maury's CK12/30/32 series VNA calibration kits as listed on pages 116-117. They may also be purchased separately as spare or replacement parts for these kits.



Available models

| MODEL | MATES WITH EQUIVALENT FLANGE | EIA WR NUMBER | FREQUENCY RANGE (GHz) |
|-------|------------------------------|---------------|-----------------------|
| S344A | UG53/U | 284 | 2.6 — 3.95 |
| E344B | CPR229F | 229 | 3.3 — 4.9 |
| G344A | UG149A/U | 187 | 3.95 — 5.85 |
| F344B | CPR159F | 159 | 4.9 — 7.05 |
| C344A | UG344/U | 137 | 5.85 — 8.2 |
| H344A | UG51/U | 112 | 7.05 — 10.0 |
| X344A | UG39/U | 90 | 8.2 — 12.4 |
| M344A | MPF75 | 75 | 10.0 — 15.0 |
| P344A | UG419U | 62 | 12.4 — 18.0 |
| N344A | MPF51 | 51 | 15.0 — 22.0 |
| K344A | UG595/U | 42 | 18.0 — 26.5 |
| | | 34 | 22.0 — 33.0 |
| U344A | UG599/U | 28 | 26.5 — 40.0 |
| K344D | UG383/U | 22 | 33.0 — 50.0 |

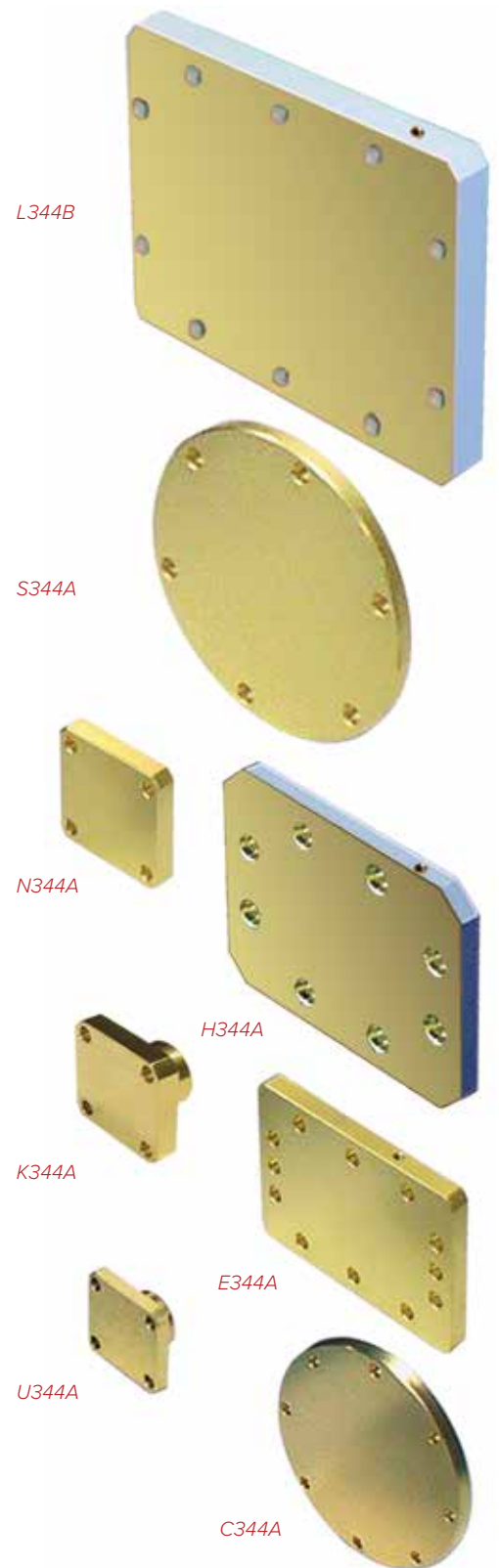

Waveguide Fixed Offset Shorts

MODEL SERIES 340

Description

Offset shorts with 1/8 and 3/8 wavelength offsets are considered one of the more accurate means of obtaining a 180° phase difference in waveguide. Using these single-piece devices will reduce the number of flange interfaces during calibration. This helps to maintain an essentially constant magnitude of current flow across the calibration plane.

The chart below lists the offset shorts available from Maury. Those in rectangular guide are nominally 1/8 and 3/8 wavelength offset at a frequency near the waveguide band center. These will not be the exact band center as the frequency is chosen to equalize the phase differences at the band edges.

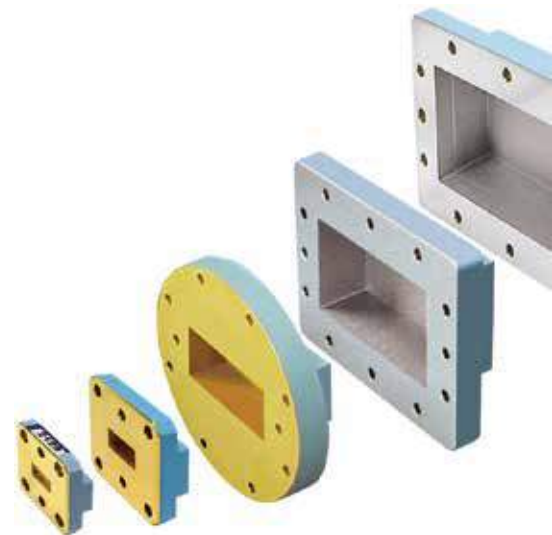

Available Models

| BAND | EIA WR NUMBER | FREQUENCY RANGE (GHz) | MODEL | OFFSET (cm) | DELAY (ps) ¹ |
|------|---------------|-----------------------|--------|-------------|-------------------------|
| S | WR284 | 2.6 — 3.95 | S340B1 | 1.524 | 50.852 |
| | | | S340B2 | 4.572 | 152.555 |
| E | WR229 | 3.3 — 4.9 | E340B3 | 1.359 | 45.346 |
| | | | E340B4 | 4.077 | 136.038 |
| G | WR187 | 3.95 — 5.85 | G340B1 | 1.026 | 34.235 |
| | | | G340B3 | 3.078 | 102.704 |
| F | WR159 | 4.9 — 7.05 | F340C1 | 0.815 | 27.194 |
| | | | F340C3 | 2.446 | 81.616 |
| C | WR137 | 5.85 — 8.2 | C340F1 | 0.686 | 22.890 |
| | | | C340F3 | 2.058 | 68.670 |
| H | WR112 | 7.05 — 10.0 | H340B1 | 0.571 | 19.067 |
| | | | H340B3 | 1.714 | 57.191 |
| X | WR90 | 8.2 — 12.4 | X340B1 | 0.483 | 16.116 |
| | | | X340B3 | 1.448 | 48.316 |
| M | WR75 | 10.0 — 15.0 | M340C1 | 0.396 | 13.213 |
| | | | M340C3 | 1.189 | 39.674 |
| P | WR62 | 12.4 — 18.0 | P340A1 | 0.352 | 11.745 |
| | | | P340A2 | 1.055 | 35.202 |
| N | WR51 | 15.0 — 22.0 | N340A | 0.267 | 8.909 |
| | | | N340B | 0.800 | 26.694 |
| K | WR42 | 18.0 — 26.5 | K340A1 | 0.251 | 8.365 |
| | | | K340A2 | 0.752 | 25.095 |
| U | WR28 | 26.5 — 40.0 | U340B | 0.150 | 5.005 |
| | | | U340C | 0.450 | 15.015 |
| J | WR22 | 33.0 — 50.0 | J340A1 | 0.120 | 4.007 |
| | | | J340B1 | 0.360 | 12.022 |

¹ Offset delay is calculated without consideration for the dispersive effect of waveguide, that is, assuming the short is in air dielectric coaxial line. This conforms to the convention established for Keysight network analyzers. Anritsu analyzers use the actual mechanical offset in centimeters.

Opens

GENERAL INFORMATION



Shielded, coaxial opens are used in the calibration of vector network analyzers to provide a nominal 180° phase offset from a compatible reference short over a wide range of frequencies.

At these frequencies, open circuit terminations are inherently imperfect. Shielding the open essentially eliminates radiation loss, but creates a residual frequency-sensitive capacitance. An accurate knowledge of the open's effective capacitance is essential to an accurate calibration of the analyzer.

Maury opens are characterized for effective capacitance versus frequency by means of a fourth order polynomial curve fit, and the nominal capacitance

coefficients are provided with each unit. We offer several innovative designs that improve the consistency and repeatability of the open's capacitance coefficients resulting in improved effective source match of the calibrated VNA ¹.

One design (seen in the 7mm models shown below) uses a beadless captivated dielectric rod in place of the center conductor contact. This rod depresses the spring-loaded contact of the test port connector so that it is flush with the outer conductor mating plane.

This creates highly accurate, precisely repeatable open circuit conditions which improve the calibration effectiveness and measurement accuracy of the open.

Another design (seen in most of the sexed models listed below) uses a center contact that is captivated and set at the factory to be essentially flush with the outer conductor mating plane, thereby eliminating dependence on test port connector tolerances and adding a high degree of performance consistency to the open.

The 371N2/P2 and 8585A1/B1 models are designed for limited frequency ranges as determined by their connector types.

In all cases, the specification "Phase Accuracy" is defined as phase deviation from a nominal unit.

Available Models

| MODEL | SEX | CONNECTOR TYPE | FREQUENCY RANGE (GHZ) | PHASE ACCURACY | MINIMUM REFLECTION COEFFICIENT |
|------------------|----------------|----------------|-----------------------|---|--------------------------------|
| 7948A2 7948B2 | female male | 2.4mm | DC — 50.0 | ±2.0° | 0.98 |
| 8773A4 8773B4 | female male | 2.92mm (K) | DC — 40.0 | ±1.5° | 0.98 |
| 8048A6 8048B6 | female male | 3.5mm | DC — 26.5 | ±1.4° | 0.98 |
| 2616D3 | — | 7mm | DC — 18.0 | ±0.3° | 0.995 |
| 8809B2 8810B2 | female male | Type N | DC — 18.0 | ±2.0° | 0.99 |
| 8609B 8610B | female male | TNC | DC — 18.0 | ±5.0° | 0.98 |
| 371N2 371P2 | female male | BNC 50Ω | DC — 12.4 | ±5.0° | 0.98 |
| 8585A1 8585B1 | female male | BNC 75Ω | DC — 12.0 | DC — 2.0 = ±1.0° 2.0 — 3.0 = ±2.0° 3.0 — 12.0 = ±6.0° | 0.98 |

¹ See Maury data sheet 5C-027.



DATA SHEET
5C-027

Precision Air Lines

GENERAL INFORMATION

Coaxial air lines are air-dielectric transmission lines with highly accurate dimensions that can be used as fundamental impedance standards in measurement and calibration applications, and may also be used to establish reference positions for measurements.

Maury offers air lines with bead supported and/or beadless connectors in a variety of popular types including, 1.85mm, 2.4mm, 2.92mm (K), 3.5mm, 7mm and type N.

Bead supported air lines offer greater convenience and easier connections (the center conductor is automatically aligned by the dielectric bead for easy connection); beadless air lines offer

7943S6.25



7943S1.25
2503B



Bead-Supported



7943S1.50
8043S15



Unsupported (air dielectric)

better impedance and electrical length accuracies, as well as lower VSWR (the center conductor floats free in the air line body, and the male connector nut is retractable to facilitate insertion of the center conductor contact before the thread-on connection tightened.

The photos at the right (above) show end views of two type N air lines. On the left is a model 2503A (representing Maury's bead supported design) and on the right is a model 2553T15 (representing Maury's beadless design). The low-loss dielectric bead in the 2503A keeps the center conductor precisely centered in the body of the air line. The photo on the right shows how the unsupported center conductor

of the 2553T15 has shifted to the left, and floats freely in the air line body until it is connected at both ends. The beadless design is a true "air" line in that it does not include any discontinuities caused by having the center conductor supported by dielectric beads. Beadless air lines are often used as "sample holders" where samples of various materials can be inserted in the air line and measured to determine the material's dielectric properties.

Specifications given for the air line models in this section include the odd 1/4-λ frequency rating. This rating indicates the frequencies at which the electrical length is an odd multiple of a 1/4 wavelength where n = zero or an integer.

Precision Air Lines Available Models

| Model | Connector Type | Frequency Range (GHz) | Electrical Length (cm) | Electrical Length Accuracy | Maximum VSWR | Odd 1/4 Wavelength Frequency (GHz) |
|-----------|----------------|-----------------------|------------------------|----------------------------|--|------------------------------------|
| 7843S0.96 | 1.85mm | DC — 67.0 | 0.960 | ±0.0025 | < 1.008 | (2n + 1) 7.8 |
| 7843S1.15 | | | 1.150 | | | (2n + 1) 6.5 |
| 7843S3.00 | | | 3.000 | | | (2n + 1) 2.5 |
| 7943S1.25 | 2.4mm | DC — 50.0 | 1.250 | ±0.0025 | < 1.008 | (2n + 1) 6.0 |
| 7943S1.50 | | | 1.500 | | | (2n + 1) 5.0 |
| 7943S6.25 | | | 6.250 | | | (2n + 1) 1.2 |
| 7942C | 2.4mm* | | 4.110 | ±0.02 | | (2n + 1) 1.8 |
| 8774S15 | 2.92mm | DC — 40.0 | 14.990 | ±0.0025 | < 1.008 | (2n + 1) 0.50 |
| 8774S6 | | | 6.000 | | | (2n + 1) 1.25 |
| 8774S5.25 | | | 5.250 | | | (2n + 1) 1.43 |
| 8774S5 | | | 4.997 | | | (2n + 1) 1.50 |
| 8776C | 2.92mm* | | 14.990 | ±0.02 | | (2n + 1) 0.5 |
| 8043S15 | 3.5mm | DC — 26.5 | 14.990 | ±0.0025 | < 1.008 | (2n + 1) 0.50 |
| 8043S6 | | | 6.000 | | | (2n + 1) 1.25 |
| 8043S5.3 | | | 5.298 | | | (2n + 1) 1.41 |
| 8043S5 | | | 4.997 | | | (2n + 1) 1.50 |
| 8042C1 | 3.5mm* | | 14.990 | ±0.02 | DC — 18.0 ≤ 1.04 18.0 — 26.5 ≤ 1.055 | (2n + 1) 0.50 |
| 8042D1 | | 9.993 | (2n + 1) 0.75 | | | |
| 2653S15 | 7mm | DC — 18.0 | 14.983 | ±0.005 | <1.005 | (2n + 1) 0.50 |
| 2653S3.12 | | | 3.120 | | | (2n + 1) 1.50 |
| 2653L | | | 0.693 | | | (2n + 1) 10.81 |
| 2603A | 7mm* | | 29.979 | ±0.015 | DC — 4.0 ≤ 1.02 4.0 — 9.0 ≤ 1.03 9.0 — 18.0 ≤ 1.06 | (2n + 1) 0.25 |
| 2603B | | 19.986 | (2n + 1) 0.375 | | | |
| 2603F1 | | 5.996 | (2n + 1) 1.25 | | | |
| 2553T15 | | Type N | | | | 14.983 |
| 2553T3.82 | 3.816 | | (2n + 1) 1.96 | | | |
| 2553T3.12 | 3.123 | | (2n + 1) 2.40 | | | |
| 2503A1 | Type N* | | 29.979 | ±0.02 | DC — 3.0 ≤ 1.03 3.0 — 10.0 ≤ 1.05 10.0 — 18.0 ≤ 1.09 | (2n + 1) 0.83 |
| 2503B1 | | 19.986 | (2n + 1) 0.84 | | | |
| 2503H | | 6.604 | (2n + 1) 1.14 | | | |

* Indicates Bead Supported Airlines

Waveguide Precision Straight Section (Shim)

MODEL SERIES 322B

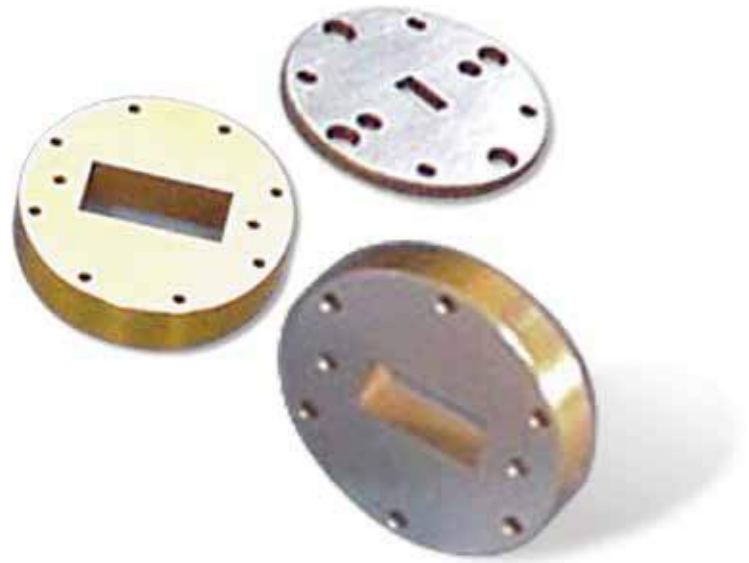

These 322B series 1/4λ straight sections are reduced height spacers or shims which provide an accurately known VSWR which is directly calculable from their mechanical dimensions. The shims are designed for a theoretical VSWR of 1.00. The shims are fabricated from aluminum and are provided with precision indexing holes for excellent flange alignment. Their simple geometry allows direct calculation of reflection, loss, transfer and group delay characteristics and makes them ideally suited for quickly checking the performance and accuracy of automated network analyzers.

Available Models

| Model | Frequency Range (GHz) | EIA WR Number | Length | | Delay (pS) |
|-------------|-----------------------|---------------|--------|----------|------------|
| | | | Inches | (CM) | |
| S322B1.198 | 2.6 – 3.95 | 284 | 1.198 | (3.0429) | 101.5334 |
| E322B0.9468 | 3.3 – 4.9 | 229 | 0.948 | (2.4079) | 80.34527 |
| G322B0.807 | 3.95 – 5.85 | 187 | 0.807 | (2.0498) | 68.39518 |
| F322B0.641 | 4.9 – 7.05 | 159 | 0.642 | (1.6307) | 54.41104 |
| C322B0.539 | 5.85 – 8.2 | 137 | 0.539 | (1.3691) | 45.68154 |
| H322B0.447 | 7.05 – 10.0 | 112 | 0.447 | (1.1354) | 37.88432 |
| X322B0.382 | 8.2 – 12.4 | 90 | 0.382 | (0.9703) | 32.37541 |
| M322B0.311 | 10.0 – 15.0 | 75 | 0.311 | (0.7899) | 26.35799 |
| P322B0.253 | 12.4 – 18.0 | 62 | 0.253 | (0.6426) | 21.44236 |
| N322B0.209 | 15.0 – 22.0 | 51 | 0.209 | (0.5309) | 17.71325 |
| K322B0.175 | 18.0 – 26.5 | 42 | 0.175 | (0.4445) | 14.83167 |
| Q322B0.1418 | 22.0 – 33.0 | 34 | 0.142 | (0.3601) | 12.01789 |
| U322B0.118 | 26.5 – 40.0 | 28 | 0.118 | (0.2997) | 10.00078 |
| J322B0.0946 | 33.0 – 50.0 | 22 | 0.0946 | (0.2403) | 8.017576 |

Waveguide Straight Sections

STRAIGHT SECTIONS AND
TRANSITIONS



Description

Maury produces waveguide components in many EIA WR sizes. A comprehensive line of standard rectangular products is available in the sizes shown below. They are generally supplied with cover flanges. Units from S through P bands are normally aluminum construction with irridite finish; K band and above are copper alloy with a plated finish. All units are painted with highly durable paint, or other special order finishes.

Available Models

| MODEL | FREQUENCY RANGE (GHz) | LENGTH | |
|--------|-----------------------|--------|--------|
| | | INCHES | (CM) |
| S102C5 | 2.60 — 3.95 | 5.0 | (12.7) |
| E102G5 | 3.30 — 4.90 | 5.0 | (12.7) |
| G102C5 | 3.95 — 5.85 | 5.0 | (12.7) |
| F102C5 | 4.90 — 7.50 | 5.0 | (12.7) |
| C103C5 | 5.85 — 8.20 | 5.0 | (12.7) |
| H103A5 | 7.05 — 10.0 | 5.0 | (12.7) |
| X103A5 | 8.20 — 12.4 | 5.0 | (12.7) |
| M103A5 | 10.0 — 15.0 | 5.0 | (12.7) |
| P103A5 | 12.4 — 18.0 | 5.0 | (12.7) |
| N102F4 | 15.0 — 22.0 | 4.0 | (10.2) |
| K103A4 | 18.0 — 26.5 | 4.0 | (10.2) |
| Q106D | 22.0 — 33.0 | 4.0 | (10.2) |
| U103A4 | 26.5 — 40.0 | 4.0 | (10.2) |
| J106B1 | 33.0 — 50.0 | 2.2 | (5.6) |

Precision Mismatches

GENERAL INFORMATION



Precision standard mismatches are fixed coaxial terminations, which are used to introduce a known VSWR into a 50 ohm transmission system. These mismatches are extremely useful in a wide variety of applications and are quick and easy to use. They can be used to calibrate swept reflectometers, verify network analyzer calibration, establish impedance references in TDR measurements, etc.

Maury standard mismatches are quality constructed using thin film resistors and a unique grounding method that ensures stable operation. For ease of identification, the VSWR value of the mismatch is engraved on the end cap.

The standard units in this section are fitted with 2.4mm, 2.92mm, 3.5mm, 7mm and type N connectors. Please

consult with our sales staff for application assistance. The units are also available as sets or kits packaged in foam-lined wood instrument cases.

Available Models

| Model | | Connector Type | Frequency Range (GHz) | Nominal VSWR | Accuracy (GHz) | |
|-----------|-----------|----------------|-----------------------|--------------|----------------|-------------|
| Female | Male | | | | DC - 12.0 | 12.0 - 50.0 |
| 7933A1.20 | 7933B1.20 | 2.4mm | DC - 50.0 | 1.20 | ±0.09 | ±0.13 |
| 7933A1.50 | 7933B1.50 | | | 1.50 | ±0.10 | ±0.20 |
| 7933A2.00 | 7933B2.00 | | | 2.00 | ±0.14 | ±0.25 |

| Model | | Connector Type | Frequency Range (GHz) | Nominal VSWR | Accuracy (GHz) | |
|-----------|-----------|----------------|-----------------------|--------------|----------------|-------------|
| Female | Male | | | | DC - 12.0 | 12.0 - 40.0 |
| 8778A1.20 | 8778B1.20 | 2.92mm | DC - 40.0 | 1.20 | ±0.08 | ±0.13 |
| 8778A1.50 | 8778B1.50 | | | 1.50 | ±0.10 | ±0.20 |
| 8778A2.00 | 8778B2.00 | | | 2.00 | ±0.14 | ±0.25 |

| Model | | Connector Type | Frequency Range (GHz) | Nominal VSWR | Accuracy (GHz) | |
|-----------|-----------|----------------|-----------------------|--------------|----------------|-------------|
| Female | Male | | | | DC - 12.0 | 12.0 - 26.5 |
| 8033A1.20 | 8033B1.20 | 3.5mm | DC - 26.5 | 1.20 | ±0.07 | ±0.10 |
| 8033A1.50 | 8033B1.50 | | | 1.50 | ±0.09 | ±0.17 |
| 8033A2.00 | 8033B2.00 | | | 2.00 | ±0.12 | ±0.22 |

| Model | | Connector Type | Frequency Range (GHz) | Nominal VSWR | Accuracy (GHz) | | |
|--------|------|----------------|-----------------------|--------------|----------------|------------|-------------|
| Female | Male | | | | DC - 8.0 | 8.0 - 12.4 | 12.4 - 18.0 |
| 2611C | | 7mm | DC - 18.0 | 1.20 | ±0.05 | ±0.06 | ±0.10 |
| 2611E | | | | 1.50 | ±0.06 | ±0.08 | ±0.17 |
| 2611G | | | | 2.00 | ±0.10 | ±0.12 | ±0.22 |

| Model | | Connector Type | Frequency Range (GHz) | Nominal VSWR | Accuracy (GHz) | | |
|--------|-------|----------------|-----------------------|--------------|----------------|------------|-------------|
| Female | Male | | | | DC - 8.0 | 8.0 - 12.4 | 12.4 - 18.0 |
| 2561C | 2562C | Type N | DC - 18.0 | 1.20 | ±0.06 | ±0.07 | ±0.10 |
| 2561E | 2562E | | | 1.50 | ±0.08 | ±0.09 | ±0.15 |
| 2561G | 2562G | | | 2.00 | ±0.12 | ±0.12 | ±0.20 |

Mismatch Airlines



Description

Maury mismatch airlines have been designed as verification standards to be used in VNA calibration validation. Each mismatch airline is provided with factory S-parameters data that can be compared with user-measured S-parameters for VNA calibration validation. Measurement uncertainty is also provided, and uncertainty boundaries can be used for definitive calibration validation when used in conjunction with MT940B Insight Real-Time Uncertainty Add-On.

Recommended Accessories

Insight Calibration and Measurement Software:

Insight is the industry's first commercial software suite designed to empower VNA users and help them make better decisions by quantifying measurement uncertainty. Insight is an agnostic software tool compatible with most commercial VNAs and represents a paradigm shift in the way users approach VNA calibration, validation, measurement, visualization and analysis. More information regarding Insight can be found in data sheet [4T-023](#).

VNA Calibration Kits:

Maury offers coaxial VNA calibration kits up to 67 GHz and waveguide calibration kits up to 50 GHz in standard connector and waveguide sizes. Coaxial 2.4mm, 2.92mm, 3.5mm, 7mm and Type N calibration kits are available as fixed-load SOLT kits with either standard polynomial equations or characterized device (CD) with individually characterized standards. More information can be found in data sheets [2Z-056](#) (1.85mm), [2Z-072](#) (2.4mm), [2Z-073](#) (2.92mm), [2Z-074](#) (3.5mm), [2Z-075](#) (7mm), and [2Z-076](#) (Type N), [2Z-062](#) (TNC), [2Z-069](#) (BNC) and [3H-081](#) (WR284 Through WR22).

Available Models

| Model | Connector Type | Frequency Range (GHz) | Electrical Length (cm) | Electrical Length Accuracy | Impedance |
|---------|----------------|-----------------------|------------------------|----------------------------|-----------|
| 7942C25 | 2.4mm | DC - 50.0 | 4.110 | ±0.02 | 25Ω |
| 8776C75 | 2.92mm | DC - 40.0 | 14.990 | ±0.02 | 25Ω |
| 8042C25 | 3.5mm | DC - 26.5 | 14.990 | ±0.02 | 25Ω |
| 2603F75 | 7mm | DC - 18.0 | 5.996 | ±0.015 | 75Ω |
| 2503H75 | Type N | DC - 18.0 | 6.604 | ±0.02 | 75Ω |

Waveguide Flange Information

MAURY PRECISION FLANGES (MPF)



Description

Maury MPF flanges are designed to provide precise mating of flanges when repeated connections are required or in systems where optimum waveguide alignment is critical. Some MPF series flanges also allow mating to more than one type of flange interface, which amplifies their versatility and economy when mating different flange types within a band. Please refer to the "mates with" column in the chart below to see the possible combinations. Please note that Maury does not sell flanges alone.

MPF flanges are provided on components used in Maury calibration kits or on low

VSWR components such as waveguide to coax adapters with VSWR of 1.10 or better.

MPF flanges in WR22 waveguide (millimeter wave sizes) provide dramatic improvements in connection consistency, repeatability and serviceability versus standard UG flanges, while still maintaining mating compatibility with these older designs (see Maury data sheet 5E-030). As in larger waveguide sizes, these flanges have two precision index holes and slip-fit alignment pins. (Threaded pins may also be installed in the standard four-pin pattern when mating to standard UG flanges. Both types of pins are removable, making the flange face available for servicing.)

MPF flanges also have a raised outer ring which prevents the mating surfaces from cocking due to uneven torque applied to the flange bolts. To obtain complete technical descriptions, please request the data sheets shown in the Maury Data Sheet column.

NOTE: All Maury MPF flanges have precision index holes. Corresponding slip-fit alignment pins are also available. Together, these ensure precise alignment and repeatable mating in waveguide connections. All Maury waveguide VNA calibration kit components come with MPF flanges. Alignment pins are available separately. See Maury data sheet 3A-996 for details.

Maury Precision Flange Reference Chart

| BAND | EIA WR NUMBER | MPF DESIGNATION | MATES WITH | MAURY DATA SHEET |
|------|---------------|-----------------|--|------------------|
| S | 284 | MPF284 | UG53/U, UG54A/U, CPR284 | 5E-002 |
| S | 284 | MPF284B | UG53/U, UG54A/U, CPR284, CMR284 | 5E-002A |
| S | 284 | MPF284C | UG53/U, UG54A/U | 5E-002B |
| E | 229 | MPF229 | CPR229, CMR229 | 5E-003 |
| E | 229 | MPF229B | CPR229 | 5E-003A |
| G | 187 | MPF187 | UG149A/U, UG148B/U, CPR187 | 5E-004 |
| G | 187 | MPF187C | UG149A/U, UG148B/U | 5E-004A |
| F | 159 | MPF159 | CPR159, CMR159 | 5E-011 |
| F | 159 | MPF159B | CPR159 | 5E-011A |
| C | 137 | MPF137 | UG344/U, UG343A/U, CPR137 | 5E-005 |
| C | 137 | MPF137C | UG344/U, UG343A/U | 5E-005A |
| H | 112 | MPF112 | UG51/U, UG138/U, CPR112F & G | 5E-001 |
| H | 112 | MPF112B | UG51/U, UG52/U | 5E-001A |
| H | 112 | MPF112C | UG51/U, UG52/U, CMR112 | 5E-001C |
| HS | 102 | MPF102 | UG1493 | 5E-014 |
| X | 90 | MPF90 | UG39/U, UG40A/U, CPR90 | 5E-006 |
| X | 90 | MPF90A | UG39/U, UG40A/U, CMR90 | 5E-006 |
| X | 90 | MPF90B | UG39/U, UG40A/U | 5E-006A |
| M | 75 | MPF75A & B | M3922/70-004 & -005 | 5E-007 |
| P | 62 | MPF62 | UG419/U, UG541A/U | 5E-008 |
| N | 51 | MPF51A & B | M3922/70-010, -011, -012, -022, -023, -024 | 5E-012 |
| N | 51 | MPF51C | Keysight Type, UBR180 | 5E-013 |
| K | 42 | MPF42 | UG595/U, UG596/U | 5E-009 |
| Q | 34 | MPF34 | UG595U, UG596/U, UG1530/U | 5E-019 |
| U | 28 | MPF28 | UG599/U, UG600/U | 5E-010 |
| J | 22 | MPF22 | UG383/U | 5E-030 |

Coaxial Stub Tuners

Description

Maury stub tuners are basic laboratory tools used for matching load impedances to provide for maximum power transfer between a generator and a load, and for introducing a mismatch into an otherwise matched system. Typical applications include power and attenuation measurements, tuned reflectometer systems and providing a DC return for single-ended mixers and detectors. Maury stub tuners are available in double- and triple-stub configurations with frequency ranges extending from 0.2 to 18.0 GHz.

Stub tuners work as impedance transformers to introduce a variable shunt susceptance into a coaxial transmission line. They consist of one or more short-circuited, variable length lines (stubs) connected at right angles to the primary transmission line. To provide all possible shunt susceptances, each stub must be movable over 1/2 wavelength at the lowest frequency of operation; therefore, the lower frequency limit of a tuner is determined by the frequency at which the maximum stub travel equals 1/2 wavelength. The upper frequency limit for a stub tuner is established by its connectors.

The inter-stub spacing of multiple-stub tuners determines the range of impedances that can be matched and the ease of tuning. Triple-stub tuners are more convenient to use since tuning sensitivity is relatively independent of stub spacing.



1778A
Double-Stub
Tuner

1819C
Triple-Stub
Tuner

Available Models

| STUB CONFIGURATION | FREQUENCY RANGE (GHz) | MODEL (BY CONNECTOR TYPE) | | STUB TRAVEL | | STUB SPACING | |
|--------------------|-----------------------|---------------------------|-------|-------------|--------|--------------|--------------|
| | | TYPE N | SMA | INCHES | (cm) | INCHES | (cm) |
| DOUBLE-STUB | 0.2 — 0.5 | 1778G | — | 30.0 | (76.2) | 4.6 | (11.7) |
| | 0.4 — 1.0 | 1778A | 1719A | 15.0 | (38.1) | 4.6 | (11.7) |
| | 0.8 — 4.0 | 1778B | 1719B | 7.5 | (19.1) | 2.0 | (5.1) |
| | 2.0 — 12.0 | 1778C | 1719C | 3.0 | (7.6) | 0.75 | (1.9) |
| | 2.0 — 18.0 | 1778E | — | 3.0 | (7.6) | 0.5 | (1.3) |
| | 4.0 — 18.0 | 1778D | 1719D | 1.75 | (4.4) | 0.5 | (1.3) |
| TRIPLE-STUB | 0.2 — 0.5 | 1878G | — | 30.0 | (76.2) | 4.6 (11.7) | / 2.0 (5.1) |
| | 0.4 — 1.0 | 1878A | 1819A | 15.0 | (38.1) | 4.6 (11.7) | / 2.0 (5.1) |
| | 0.8 — 4.0 | 1878B | 1819B | 7.5 | (19.1) | 1.0 (2.5) | / 0.75 (1.9) |
| | 2.0 — 18.0 | 1878C | 1819C | 3.0 | (7.6) | 0.75 (1.9) | / 0.5 (1.3) |
| | 4.0 — 18.0 | 1878D | 1819D | 1.75 | (4.4) | 0.75 (1.9) | / 0.5 (1.3) |



DATA SHEET
2G-008

Noise Calibration Systems and Components

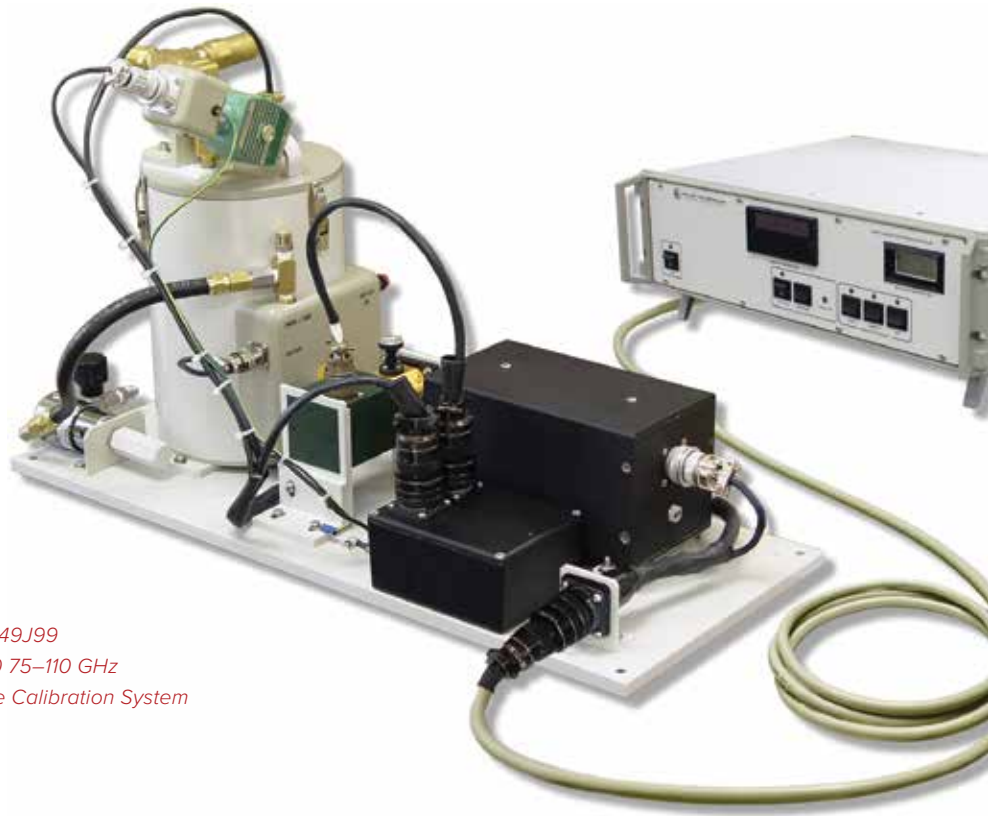

MT7149J99
WR10 75–110 GHz
Noise Calibration System

Introduction

The Maury Noise Calibration Systems (NCS) are self-contained, highly accurate sources of RF and microwave noise power. These systems are used wherever noise source accuracy is critical. Examples are: receiver noise measurements such as noise figure and effective input noise temperature; calibration of solid state noise sources; evaluation and verification of earth station receivers; and as radiometer reference sources.

Each NCS consists of one (hot or cold), two (hot and cold) or three (hot/ambient/cold) thermal noise sources whose outputs can be conveniently switched into a single calibrated output port. This capability makes for a unique combination of accuracy and convenience. The incorporation of the output switch makes the operation of the NCS in a noise performance measurement as convenient as a solid state noise generator – without the accuracy penalty associated with the

latter. The plot shown at right illustrates the improvement in accuracy that can be gained by the use of an NCS in a typical measurement application (effective input noise temperature).

The cold noise source is a liquid nitrogen (LN₂) cooled termination. A liquid nitrogen level sensor and an automatic fill system maintains the proper nitrogen level. The user must provide a suitable liquid nitrogen reservoir. The cold termination is also pressurized with helium at 2 psi. Pressure is maintained by a regulator that requires 20 psi maximum from an external user-supplied source. Since most helium bottles are pressurized to about 1,000 psi or more, the MT152C pressurizing system is included.

The hot noise source is a heated termination whose temperature is maintained by proportional control to better than $\pm 0.2\text{K}$ by the MT155J controller. Actual temperature is indicated by a digital readout on the controller front panel.

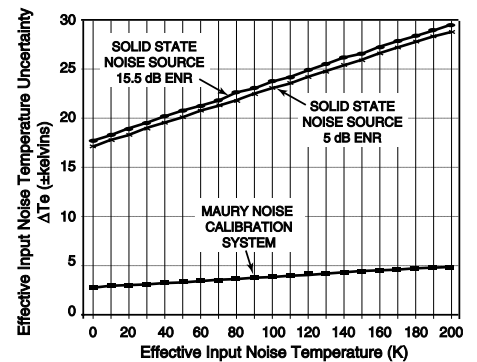

DATA SHEET
4N-062

Noise Calibration Systems and Components

(CONTINUED)

Typical NCS Models

The table below shows some of the more popular NCS available from Maury. Each model is a complete system made up of the appropriate terminations assembled on a mounting plate, the MT155J controller and the interconnecting cable. All dual-load systems shown consist of cold (LN2) and heated terminations. The tri-load system (MT7208J99) includes an ambient termination as well. Please consult our Sales Department if you do not see a noise calibration system in this table suitable for your application or if you would like more detailed information on any of these systems.

| Frequency Range | Transmission Line | Connector or Flange | Cryogenic | Thermal | Dual-Load | Tri-Load |
|-----------------|-------------------|---------------------|-----------|-----------|-----------|-----------|
| DC — 18.0 | Coaxial | 7mm | MT7118J99 | MT7108J99 | MT7098J99 | MT7208J99 |
| 3.3 — 4.9 | WR229 | MPF229B | N/A | MT7005J99 | N/A | N/A |
| 7.05 — 10.0 | WR112 | UG51/U | MT7040J99 | N/A | N/A | N/A |
| 8.2 — 12.4 | WR90 | MPF90 | MT7041J99 | MT7081J99 | MT7091J99 | N/A |
| 10.0 — 15.0 | WR75 | MPF75B | MT7042J99 | MT7082J99 | MT7093J99 | N/A |
| 12.4 — 18.0 | WR62 | UG419/U | MT7043J99 | N/A | N/A | N/A |
| 15.0 — 22.0 | WR51 | MPF51B | MT7044J99 | MT7009J99 | MT7094J99 | N/A |
| 18.0 — 26.5 | WR42 | UG595/U | MT7021J99 | MT7084J99 | MT7095J99 | N/A |
| 26.5 — 40.0 | WR28 | UG599/U | MT7022J99 | MT7085J99 | MT7096J99 | N/A |
| 33.0 — 50.0 | WR22 | UG383/U | MT7023J99 | MT7086J99 | MT7097J99 | N/A |
| 50.0 — 75.0 | WR15 | UG385/U | MT7025J99 | MT7088J99 | MT7100J99 | N/A |
| 60.0 — 90.0 | WR12 | UG385/U | MT7026J99 | MT7089J99 | MT7101J99 | N/A |
| 75.0 — 110.0 | WR10 | UG385/U | MT7027J99 | MT7090J99 | MT7149J99 | N/A |

Cryogenic Noise Terminations (Cold Loads)



MT7025J99 with Power Supply and Foam-lined Wood Carrying Case.

Introduction

Maury cryogenic terminations are liquid nitrogen cooled loads which provide accurately known noise power at a well matched output port. Used with ambient and/or thermal terminations and a noise figure meter, these terminations provide cold reference temperatures needed for highly accurate noise figure or effective input noise temperature measurements. Because of the accuracy of their noise output, cryogenic terminations are often used as a noise standard for calibration of solid state noise generators.

The accuracy achieved by these terminations is possible because they utilize the known temperature of

boiling liquid nitrogen as a constant for calculating noise temperature. Because of this, measurements made with these terminations are traceable to the fundamental quantity, temperature and NIST via temperature and network calibration standards. Each unit is provided with a swept data calibration report which includes VSWR and available output noise temperature data at standard frequencies. See Maury data sheet 4E-020, which provides specifics for the MT7250 series Noise Calibration Swept Data Module, a software tool that allows users to work with non-standard data points in addition to, or in place of the factory standards.

The cryogenic terminations require user-provided liquid nitrogen and dry helium gas at 2 psi. Maury's MT152A pressurization system is available as an optional accessory to regulate the helium pressure (see page 136). The terminations include a heater circuit to prevent frosting on the output connector and to prevent the heat load of the device under test from affecting the output noise temperature.

MT7118J99 7mm Coaxial Cryogenic Terminations

DC TO 18.0 GHZ

Features

- > Accurate Noise Temperature at Specified Calibration Frequencies
- > Low VSWR Across the Full Frequency Range
- > Liquid Nitrogen Cooled
- > Metrology Grade Calibration for Solid State Noise Generators
- > Low Noise Figure/Temperature Measurements



Description

The MT7118J99 cryogenic termination is a liquid nitrogen cooled noise source that provides accurately known noise temperatures at specified calibration frequencies and low VSWR over the full frequency range. It is used for performing accurate noise temperature measurements in 7mm applications such as certification of the noise performance of low noise earth stations. It is also used for general purpose, low noise figure/temperature measurements and calibration of solid state noise generators.

The MT7118J99 comes with a linear power supply that operates on line voltages of 120 VAC/60 Hz or 240 VAC/50 Hz, while supplying 48 VDC to the device power input.

The MT7118J99 can be packaged with an extensive complement of options and accessories, including calibrated adapters to other coaxial connector series and waveguide, and user specified calibration frequencies. Our sales staff will be happy to assist in tailoring the best package for your application.

The MT7118J99 can be optimized for VSWR and input noise temperature over other bandwidths. For calibration frequencies see Maury data sheet 4E-020, which covers the maury MT7250 series Noise Calibration Swept Data Module; a software tool that works with Microsoft® Excel® 2003 (or later) to provide an Effective Noise Temperature Interpolator. Please contact our Sales Department for additional information.

Maury also produces an extensive line of precision hot, cold and ambient terminations in both coaxial and waveguide configurations. Our sales staff is ready to assist you in ordering the right noise calibration solution for your applications.

Pressurizing System

Maury cryogenic terminations require helium gas pressurization at 2 psi. The optional MT152A pressurizing system (see page 140) provides the valves, gages, and hardware necessary to connect an external helium gas supply to Maury cryogenic terminations (helium gas supply is not provided).

Specifications

Frequency Range // DC to 18.0 GHz
Maximum VSWR: //
1.06, DC to 4.0 GHz
1.10, 4.0 to 12.0 GHz
1.15, 12.0 to 18.0 GHz
Operating Temperature (Load) //
77.36°K (liquid N cooled)

Calibration Frequencies & Noise Temperature

Uncertainty // ± 1.5 K
Connector // 7mm
Operating Orientation // Horizontal
Operating Life // 2 hours minimum (one fill)
Dewar Capacity // 1 liter
Weight // 7 lbs approximate (empty)
Pressurization //
2 psi helium gas (external supply)
AC Power //
100 to 240 VAC, 47 to 63 Hz
6.0 amps maximum
Accessories (provided) //
One (1) two meter power cord and a wooden instrument case

Note: For calibration frequencies, see the information on Maury's MT7250 series Noise Calibration Swept Data Module software (page 145), or consult our Sales Department.

Waveguide Cryogenic Terminations

MT70XX SERIES

Features

- > Accurate Noise Temperature at Specified Calibration Frequencies
- > Low VSWR Across the Full Frequency Range
- > Liquid Nitrogen Cooled
- > Metrology Grade Calibration for Solid State Noise Generators
- > Low Noise Figure/Temperature Measurements



Description

Maury offers waveguide cryogenic terminations in several styles and a wide range of waveguide sizes from WR430 through WR15. The table below represents a typical sample of the available terminations.

Waveguide terminations are calibrated within the waveguide band (using Maury MT7250 Noise Calibration Swept Data Module (see page 145). Additional user-specified calibration frequencies are also available as an option.

In addition to liquid nitrogen, these terminations require pressurization with helium gas (not provided) at 2 psi. The MT152A pressurizing system (see page 140) is available to provide proper regulation of the helium supply.

The MT70xx series units come with a universal input power supply that operates on line voltages of 100–240 VAC and 47–63 Hz, while supplying 48 VDC to the device power input.

Available Model Series (Typical)

| Model | Frequency Range (GHz) | EIA Waveguide Size | VSWR (maximum) |
|-----------|-----------------------|--------------------|----------------|
| MT7040J99 | 7.05 – 10.0 | WR112 ¹ | 1.08 |
| MT7041J99 | 8.2 – 12.4 | WR90 ¹ | 1.10 |
| MT7042J99 | 10.0 – 15.0 | WR75 | 1.08 |
| MT7043J99 | 12.4 – 18.0 | WR62 ¹ | 1.10 |
| MT7044J99 | 15.0 – 22.0 | WR51 ¹ | 1.10 |
| MT7021J99 | 18.0 – 26.5 | WR42 ¹ | 1.08 |
| MT7022J99 | 26.5 – 40.0 | WR28 ¹ | 1.10 |
| MT7023J99 | 33.0 – 50.0 | WR22 ¹ | 1.15 |
| MT7025J99 | 50.0 – 75.0 | WR15 ¹ | 1.15 |
| MT7026J99 | 60.0 – 90.0 | WR12 ¹ | 1.15 |
| MT7027J99 | 75.0 – 110.0 | WR10 ¹ | 1.15 |

Calibration Uncertainty

| Frequency Range (GHz) | Calibration Uncertainty |
|-----------------------|-------------------------|
| < 18.0 | ±1.5 K |
| 18.0 – 40.0 | ±1.5 K |
| 40.0 – 50.0 | ±1.8 K |
| 50.0 – 110.0 | ±2.6 K |

¹ Flange mates with the applicable military (UG) flange.

Cryogenic Termination Accessories

MT152A/C Helium Pressurizing Systems

Maury cryogenic terminations must be supplied with helium gas at about 2 psi to purge contaminants (air, carbon dioxide, etc.) from the coaxial or waveguide transmission line (connecting the cooled termination to the output connector) before the dewar is filled with liquid nitrogen. For stand-alone cryogenic terminations, the MT152A regulates the helium supply by use of a two-stage pressure regulator preset to provide 2 to 3 psi output pressure and a safety pressure relief valve set to 4 psi.

These are included with an 8 foot hose and CGA-580 fittings for connecting your helium supply to the termination.

Maury dual-load and tri-load noise calibration systems are provided with the MT152C helium pressurizing system, a modified version of the MT152A, which serves the same purpose.



Thermal Noise Terminations (Hot Loads)



MT151C



MT7090J99

Introduction

Maury thermal terminations are low-mismatch, heated loads in a precisely controlled thermal environment which provide an accurately known noise power. Used with ambient and/or cryogenic terminations and a noise figure meter, these terminations provide the hot termination temperature needed for highly accurate noise figure or effective input noise temperature measurements. Because of the accuracy of the noise output, thermal terminations are often used as a noise standard for calibration of solid state noise generators.

The accuracy achieved by these terminations is possible because they utilize the proven concept of thermal

(Johnson) noise operating in a precision thermal environment provided by the MT151C temperature controller. (The MT151C is a highly stable, proportional temperature controller that is accurately calibrated against NIST-traceable temperature measuring equipment.) This is the same concept used in several national standards laboratories and NIST at the higher microwave frequencies.

The termination and the controller are matched during calibration; therefore, the two instruments must be purchased as a unit. In addition, a line voltage option must be specified. Each unit is provided with a calibration report which includes VSWR and available output noise temperature at specific frequencies.

Maury offers the MT7250 series Noise Calibration Swept Data Module as a tool that allows users to work with non-standard data points in addition to, or in place of the factory standards¹. Other accessories such as special instrument cases and calibrated adapters to other coaxial series or waveguide are also available.

¹ See Maury Data Sheet 4E-020. See also page 145.

Coaxial Thermal Termination

MT7108J99



Description

Maury offers a single thermal noise termination model (the MT7108J99), which is equipped with a precision 7mm coaxial output connector, and operates from DC to 18 GHz. This compact, reliable instrument is equally suited for both field measurements and laboratory use. It is generally used to make accurate low noise figure/temperature measurements and for calibration of solid state noise generators. The flexibility and versatility of the MT7108J99 are enhanced by an extensive selection of options and accessories. These include calibrated adapters to other coaxial connector series and waveguide flanges, and factory calibration specified frequencies. (Maury's MT7250 series Noise Calibration Swept Data Module is included as a tool that allows users to work with non-standard data points in addition to, or in place of the factory standards¹.)

The MT7108J99 comes with a MT151C controller, with which it is precisely matched during the initial factory calibration. For accurate performance, these units must be used together. The MT151C's internal proportional controller responds to sensors in physical proximity to the termination and directs the MT7108J99's heater circuit to maintain the physical temperature of the termination at 373.1 kelvins (100°C). Heavy insulation of the entire termination assembly minimizes the effects of the external environment. The MT151C's line voltage must be specified at the time of order. This ensures that the MT151C will be properly fused and shipped with the appropriate power cable (AC power option 22 for 100/120 VAC, 50/60 Hz, or option 32 for 220/240 VAC, 50/60 Hz).

A certified calibration report with traceability to NIST is provided with each unit.

Specifications

Frequency Range // DC to 18 GHz
Nominal Physical Load Temperature // 373.1 K
Load Temperature Stability // ± 0.2 K

VSWR (maximum):

DC to 4 GHz // 1.06
4 to 12 GHz // 1.10
12 to 18 GHz // 1.15

AC Power (User specifies one of two options):

Option 22 // 100/120 VAC, 50/60 Hz
Option 32 // 220/240 VAC, 50/60 Hz
Noise Temperature Uncertainty // ± 0.7 K
Connector // Precision 7mm²

Accessories Provided

- > One (1) MT151C controller
- > One (1) MT151P controller cable
- > One (1) Instrument case

¹ See Maury data sheet 4E-020 for details, and page 145 in this volume.

² Precision 7mm per Maury data sheet 5E-060.

Waveguide Thermal Terminations

MT70XX SERIES



MT151C

MT7090J99

Description

Maury offers waveguide thermal terminations in several styles and a wide range of waveguide sizes, from WR430 through WR10. The chart below represents a typical sample of the available terminations.

Waveguide terminations are calibrated at frequencies within the applicable frequency range. Maury's MT7250 series Noise Calibration Swept Data Module is included as a tool that allows users to work with non-standard data points in addition to, or in place of the factory standards¹. Please contact our Sales Department for more information.

The physical temperature of the waveguide terminations is 350 kelvins with a stability of ± 0.2 kelvins. These terminations are calibrated with a specific temperature controller, and the two instruments are provided as a unit. A line voltage option must be specified at the time of order.

Available Models

| Model | Frequency Range (GHz) | EIA Waveguide Size | Maximum VSWR |
|-----------|-----------------------|--------------------|--------------|
| MT7005J99 | 3.3 – 4.9 | WR229 ² | 1.07 |
| MT7081J99 | 8.2 – 12.4 | WR90 ³ | 1.10 |
| MT7082J99 | 10.0 – 15.0 | WR75 | 1.08 |
| MT7009J99 | 15.0 – 22.0 | WR51 ³ | 1.10 |
| MT7084J99 | 18.0 – 26.5 | WR42 ³ | 1.08 |
| MT7085J99 | 26.5 – 40.0 | WR28 ³ | 1.10 |
| MT7086J99 | 33.0 – 50.0 | WR22 ³ | 1.15 |
| MT7088J99 | 50.0 – 75.0 | WR15 ³ | 1.15 |
| MT7089J99 | 60.0 – 90.0 | WR12 ³ | 1.15 |
| MT7090J99 | 75.0 – 110.0 | WR10 ³ | 1.15 |

¹ See Maury data sheet 4E-020 and page 145 in this volume.

² Flange mates with applicable CPR and CMR flanges.

³ Flange mates with the applicable military (UG) flange.

Calibration Uncertainty

| Frequency Band (GHz) | Uncertainty (Kelvins) |
|----------------------|-----------------------|
| < 18.0 | ± 0.70 K |
| 18.0 – 40.0 | ± 0.60 K |
| 40.0 – 50.0 | ± 0.65 K |
| 50.0 – 110.0 | ± 1.00 K |

Accessories Provided

- > One (1) MT151C controller
- > One (1) MT151P controller cable
- > One (1) Instrument case

Thermal Terminations – Options and Accessories



MT151C

Temperature Controller, MT151C

A temperature controller is provided with each thermal termination. The controller and the termination are calibrated together and are sold as a unit. A line voltage must be specified at the time of order:

- > Option 22 // 100/120 VAC
- > Option 32 // 220.240 VAC



Instrument Case

Most Maury heated terminations are supplied in a foam-lined instrument case (like the one shown at below) for convenient handling and storage. Please contact our Sales Department for details.

*A typical foam-lined Instrument case with one (1) model **MT7090J99**, one (1) calibrated **MT151C** Controller and one (1) Operating Manual.*

Noise Calibration Swept Data Module

MT7250 SERIES

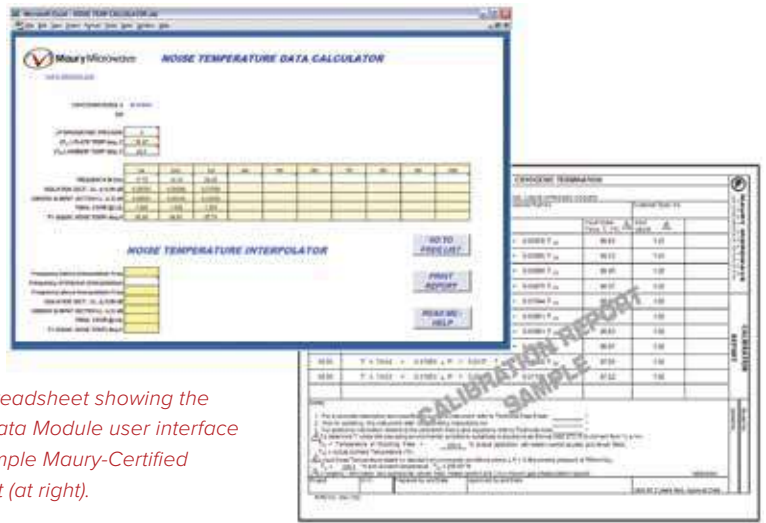

Typical Excel® spreadsheet showing the MT7250 Swept Data Module user interface (above) and a sample Maury-Certified Calibration Report (at right).

Features

- > Multiple Data Points
- > Effective Noise Temperature Calculator
- > Effective Noise Temperature Interpolator
- > Certified Calibration Report Generator
- > Standard and User-Defined Frequencies

Description

Maury cryogenic and thermal terminations, whether stand-alone models or components of Maury noise calibration systems, are calibrated for hot/cold noise temperatures at their output connectors for a number of frequencies. Waveguide units are typically calibrated at specific standard frequencies or data points at

the band edges and the arithmetic center frequency of the waveguide. Coaxial units are calibrated within the frequency range the connector type is rated for. Maury offers the MT7250 series Noise Calibration Swept Data Module as a tool that allows users to work with other, non-standard, data points in addition to, or in place of, the factory standards.

The MT7250 series Swept Data Module Software works with Microsoft® Excel® 2003¹ (or later) to give users the ability to generate standardized, or customized, Maury-certified calibration reports for any Maury cryogenic termination, thermal termination or noise calibration system. The data module can be supplied with a new unit at time of purchase, or with a re-certified unit.

¹ Not provided.

The Effective Noise Temperature Calculator

The Effective Noise Temperature Calculator uses measured loss and actual temperature data to produce Maury-certified calibration reports. These reports are based on a) pre-measured data points as shown in the table below, or b) a user-defined or customized set of measured data points, or c) a combination of both.

The Effective Noise Temperature Interpolator

For use as a reference tool, the built-in Effective Noise Temperature Interpolator can be used to generate noise temperatures for non-measured data points within the data band of interest.

Standard Pre-Measured Data Points

| Waveguide or Line | Frequency Band (GHz) | Step Size |
|-------------------|----------------------|-----------|
| 7mm | 0.2 – 18.0 | 0.20 |
| WR229 | 3.3 – 4.9 | 0.01 |
| WR112 | 7.05 – 10.0 | 0.05 |
| WR90 | 8.2 – 12.4 | 0.05 |
| WR75 | 10.0 – 15.0 | 0.10 |
| WR62 | 12.4 – 18.0 | 0.10 |
| WR51 | 15.0 – 22.0 | 0.10 |
| WR42 | 18.0 – 26.5 | 0.10 |
| WR28 | 26.5 – 40.0 | 0.25 |
| WR22 | 33.0 – 50.0 | 0.25 |
| WR15 | 50.0 – 75.0 | 0.50 |
| WR12 | 60.0 – 90.0 | 0.50 |
| WR10 | 75.0 – 110.0 | 0.50 |

Test & Measurement Instrument Amplifiers





—TEST & MEASUREMENT INSTRUMENT AMPLIFIERS



Features and Benefits

- > Based on state-of-the-art GaN PA modules
- > Wideband frequency coverage for modern applications
- > High continuous power across the band
- > High linearity for wideband communications testing
- > Integrated protection circuitry
- > Variable gain adjustment
- > High-resolution display shows amplifier status
- > Burn-in and ageing tested for long-term reliability
- > Advanced electrical test using state-of-the-art measurement equipment

Applications Expertise, Reliability and Support

Not all amplifiers are created equal, so how can you be certain that an amplifier will work for your needs? You deserve to be confident that the amplifiers used with your test-and-measurement lab benches will meet the requirements of your specific applications, are reliable, and are equally well-supported pre-and post-sale. When it comes to application expertise, reliability and support, there is no company that does it better than Maury Microwave.

With more than 60 years of experience, we are the application experts, having designed, manufactured, trained and supported turnkey measurement and modeling device characterization solutions. Our expertise includes specialization in 4G and 5G base station and handset transistor model extraction and validation, RADAR transistor model extraction and validation, 4G, 5G, WiFi and WLAN PA and FEM design and design-validation test (DVT), as well as general 50Ω and non-50Ω characterization.

We are uniquely positioned to combine our measurement and load pull expertise with modern solid-state power amplifier design practices to deliver best-in-class instrument amplifiers. Our amplifiers satisfy a wide range of application-specific requirements including simultaneous high-power, wide bandwidth, low harmonic power and high linearity.

We make use of our extensive test facilities to ensure our amplifiers meet your reliability expectations, testing each shipped unit according to our high standards. Burn-in and ageing tests include prolonged storage under extreme temperature conditions, extended amplifier operation over the entire rated temperature range, and elongated usage at maximum power under CW and pulsed-CW conditions.

After burn-in and ageing, each instrument amplifier is tested using a state-of-the-art vector-receiver measurement system. This system allows us to independently measure power at the fundamental, harmonic and intermodulation frequencies using single-tone and two-tone input signals, as well as true ACPR using wideband modulated signals. Not only are MPA-series amplifiers best-in-class, but so are our test methodologies.

Maury Microwave, the best choice for applications expertise, reliability and support.

Our application team is here to support you through your evaluation, integration and support process.



DATA SHEET
4T-101

Amplifier Frequency Map

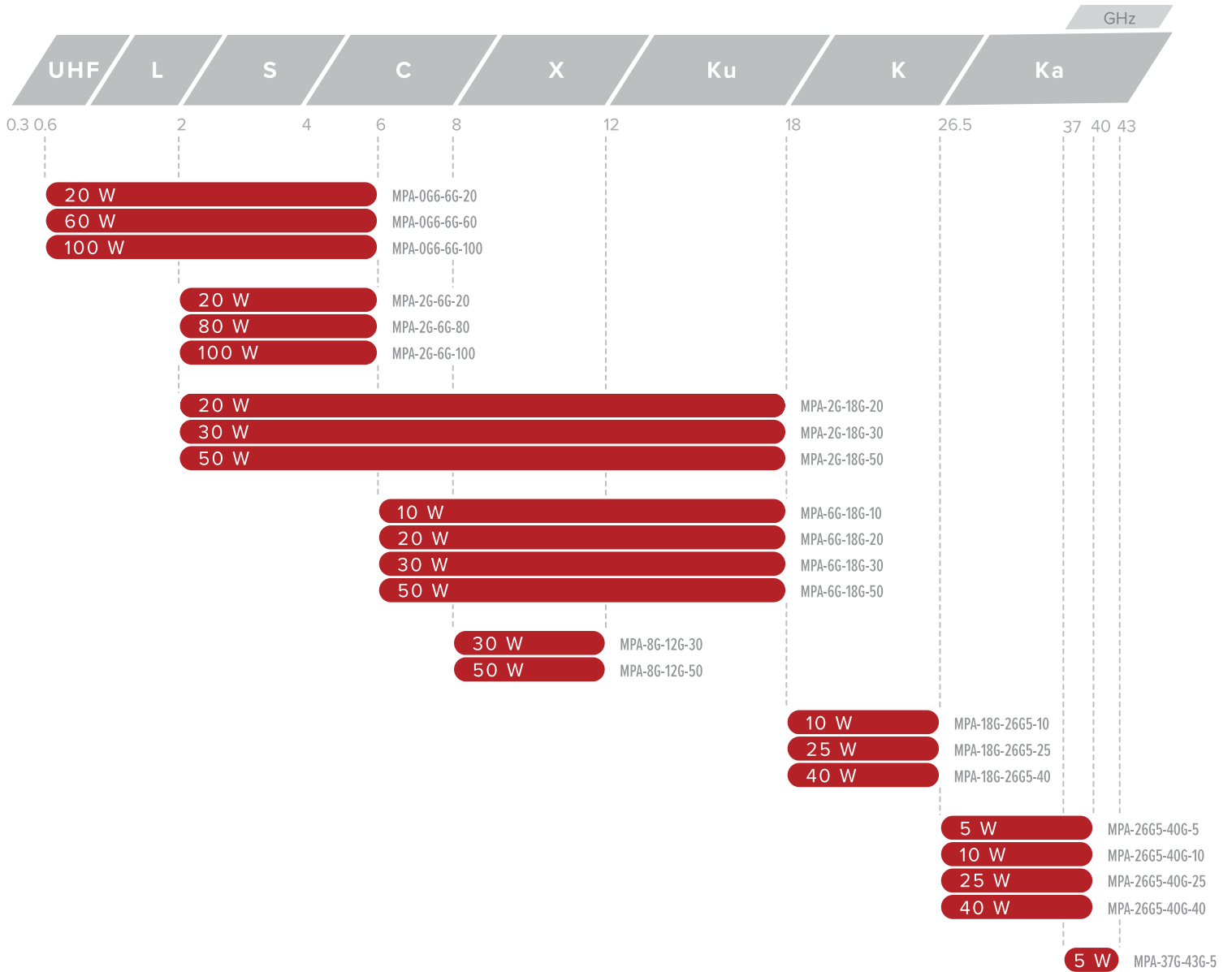

Available Models

| Model Series | Frequency (GHz) | Typical Psat (W) | Min. Psat (W) | Min. Small Signal Gain (dB) | Gain Adj. (dB) Max. | Typ. 2nd Harmonic Power @ Psat (dBc) | Page Reference |
|-----------------|-----------------|------------------|---------------|-----------------------------|---------------------|--------------------------------------|----------------|
| MPA-0G6-6G-20 | 0.6-6 | 20 | 20 | 46 | 20 | -15 | 151 |
| MPA-0G6-6G-60 | 0.6-6 | 60 | 60 | 50 | 20 | -15 | 152 |
| MPA-0G6-6G-100 | 0.6-6 | 100 | 100 | 53 | 20 | -15 | 153 |
| MPA-2G-6G-20 | 2-6 | 20 | 20 | 45 | 20 | -15 | 154 |
| MPA-2G-6G-80 | 2-6 | 80 | 80 | 49 | 20 | -15 | 155 |
| MPA-2G-6G-100 | 2-6 | 100 | 100 | 52 | 20 | -15 | 156 |
| MPA-2G-18G-20 | 2-18 | 20 | 20 | 41 | 20 | -15 | 157 |
| MPA-2G-18G-30 | 2-18 | 30 | 30 | 47 | 20 | -15 | 158 |
| MPA-2G-18G-50 | 2-18 | 50 | 50 | 49 | 20 | -15 | 159 |
| MPA-6G-18G-10 | 6-18 | 10 | 10 | 43 | 20 | -15 | 160 |
| MPA-6G-18G-20 | 6-18 | 20 | 20 | 45 | 20 | -15 | 161 |
| MPA-6G-18G-30 | 6-18 | 30 | 30 | 45 | 20 | -15 | 162 |
| MPA-6G-18G-50 | 6-18 | 50 | 50 | 50 | 20 | -15 | 163 |
| MPA-8G-12G-30 | 8-12 | 30 | 30 | 47 | 20 | -35 | 164 |
| MPA-8G-12G-50 | 8-12 | 50 | 50 | 49 | 20 | -35 | 165 |
| MPA-18G-26G5-10 | 18-26.5 | 10 | 10 | 40 | 15 | NA | 166 |
| MPA-18G-26G5-25 | 18-26.5 | 25 | 20 | 45 | 15 | NA | 167 |
| MPA-18G-26G5-40 | 18-26.5 | 40 | 40 | 49 | 15 | NA | 168 |
| MPA-26G5-40G-5 | 26.5-40 | 5 | 5 | 40 | 15 | NA | 169 |
| MPA-26G5-40G-10 | 26.5-40 | 10 | 10 | 40 | 15 | NA | 170 |
| MPA-26G5-40G-25 | 26.5-40 | 25 | 20 | 43 | 15 | NA | 171 |
| MPA-26G5-40G-40 | 26.5-40 | 40 | 40 | 43 | 15 | NA | 172 |
| MPA-37G-43G-5 | 37-43 | 5 | 5 | 33 | 15 | NA | 173 |

MPA-0G6-6G-20

0.6-6 GHz, 20W

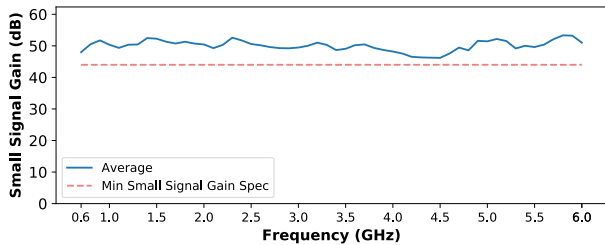
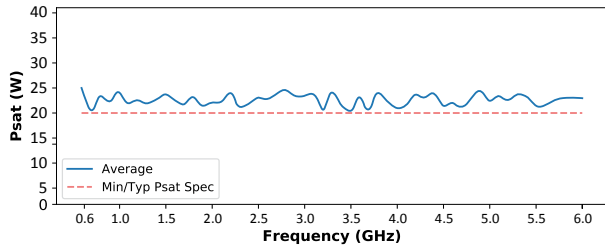

Specifications

Frequency Range:0.6-6 GHz
Psat:Typical 20 W, Minimum 20 W
Input Power:.....Maximum 0 dBm
Small Signal Gain:Minimum 46 dB
Gain Flatness:.....Typical ± 4 dB
Gain Adjustment:.....20 dB
VSWR (Input):.....Maximum 2:1
2nd Harmonic Power @ Psat:Typical -15 dBc
Spur @ Psat:.....Typical -65 dBc
IM3' @ 13 dB back off:Typical -39 dBc
IM3' @ 3 dB back off:.....Typical -27 dBc
Unconditionally Stable
VSWR Load @Psat:3:1
ECCN:.....EAR99
Warranty:.....24 months

* 10 MHz Tone spacing

Mechanical Specifications

Enclosure Type:.....B
Weight:26 lbs
RF Input/Output:SMA Female

Environmental Specifications

Operating Temp:.....0°C to 50°C
Storage Temp:.....-25°C to 65°C

MPA-0G6-6G-60

0.6-6 GHz, 60W

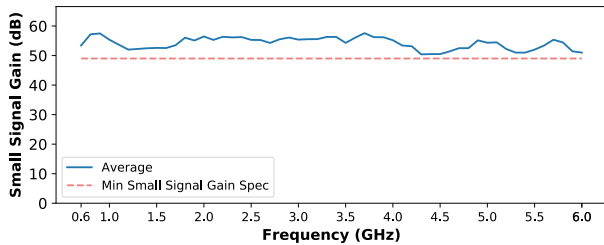
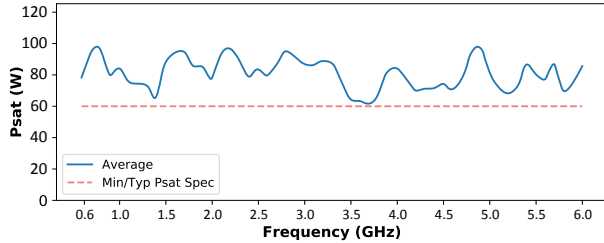

Specifications

Frequency Range:0.6-6 GHz
Psat:Typical 60 W, Minimum 60 W
Input Power:.....Maximum 0 dBm
Small Signal Gain:Minimum 50 dB
Gain Flatness:.....Typical ± 4 dB
Gain Adjustment:.....20 dB
VSWR (Input):.....Maximum 2:1
2nd Harmonic Power @ Psat:Typical -15 dBc
Spur @ Psat:.....Typical -65 dBc
IM3' @ 13 dB back off:Typical -39 dBc
IM3' @ 3 dB back off:.....Typical -25 dBc
Unconditionally Stable
VSWR Load @Psat:3:1
ECCN:.....EAR99
Warranty:.....24 months

* 10 MHz Tone spacing

Mechanical Specifications

Enclosure Type:.....A
Weight:42.3 lbs
RF Input/Output:Type N Female

Environmental Specifications

Operating Temp:.....0°C to 50°C
Storage Temp:.....-25°C to 65°C

MPA-0G6-6G-100

0.6-6 GHz, 100W

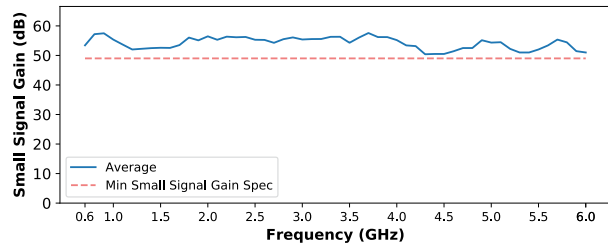
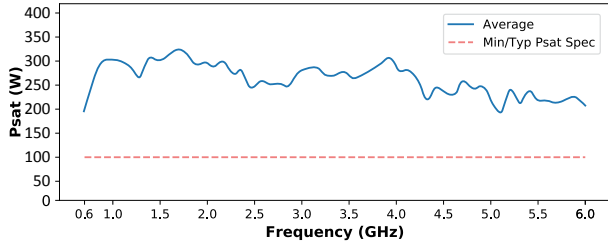

Specifications

Frequency Range:0.6-6 GHz
 Psat:Typical 100 W, Minimum 100 W
 Input Power:.....Maximum 0 dBm
 Small Signal Gain:Minimum 50 dB
 Gain Flatness:.....Typical ± 4 dB
 Gain Adjustment:.....20 dB
 VSWR (Input):.....Maximum 2:1
 2nd Harmonic Power @ Psat:Typical -15 dBc
 Spur @ Psat:.....Typical -65 dBc
 IM3' @ 13 dB back off:Typical -39 dBc
 IM3' @ 3 dB back off:.....Typical -25 dBc
 Unconditionally Stable
 VSWR Load @Psat:3:1
 ECCN:.....EAR99
 Warranty:.....24 months

** 10 MHz Tone spacing*

Mechanical Specifications

Enclosure Type:.....C
 Weight:84 lbs
 RF Input/Output:Type N Female

Environmental Specifications

Operating Temp:.....0°C to 50°C
 Storage Temp.:.....-25°C to 65°C

MPA-2G-6G-20

2-6 GHz, 20W

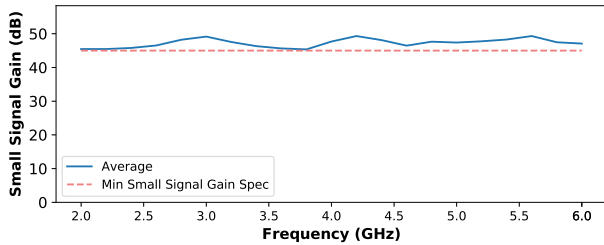
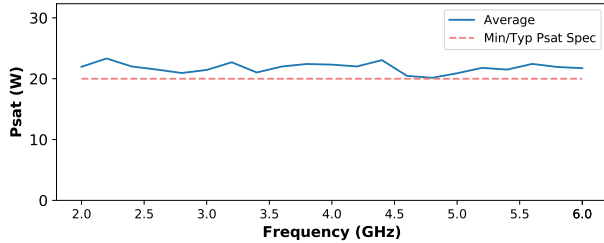

Specifications

Frequency Range:2-6 GHz
 Psat:Typical 20 W, Minimum 20 W
 Input Power:.....Maximum 0 dBm
 Small Signal Gain:Minimum 45 dB
 Gain Flatness:.....Typical ± 2 dB
 Gain Adjustment:.....20 dB
 VSWR (Input):.....Maximum 2:1
 2nd Harmonic Power @ Psat:Typical -15 dBc
 Spur @ Psat:.....Typical -65 dBc
 IM3' @ 13 dB back off:Typical -44 dBc
 IM3' @ 3 dB back off:.....Typical -29 dBc
 Unconditionally Stable
 VSWR Load @Psat:3:1
 ECCN:.....EAR99
 Warranty:.....24 months

** 10 MHz Tone spacing*

Mechanical Specifications

Enclosure Type:.....A
 Weight:19 lbs
 RF Input/Output:SMA Female

Environmental Specifications

Operating Temp:.....0°C to 50°C
 Storage Temp:.....-25°C to 65°C

MPA-2G-6G-80

2-6 GHz, 80W

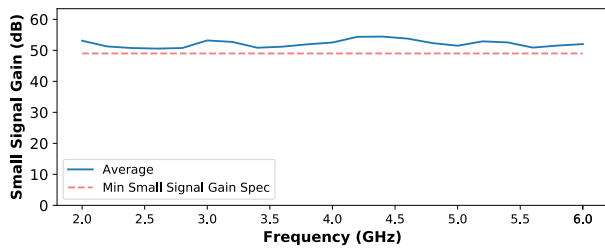
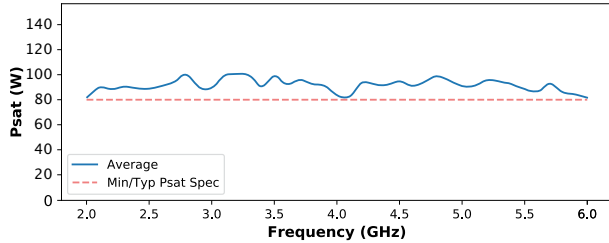

Specifications

Frequency Range:2-6 GHz
Psat:Typical 80 W, Minimum 80 W
Input Power:.....Maximum 3 dBm
Small Signal Gain:Minimum 49 dB
Gain Flatness:.....Typical ± 2 dB
Gain Adjustment:.....20 dB
VSWR (Input):.....Maximum 2:1
2nd Harmonic Power @ Psat:Typical -15 dBc
Spur @ Psat:.....Typical -65 dBc
IM3' @ 13 dB back off:Typical -44 dBc
IM3' @ 3 dB back off:.....Typical -29 dBc
Unconditionally Stable
VSWR Load @Psat:3:1
ECCN:.....EAR99
Warranty:.....24 months

* 10 MHz Tone spacing

Mechanical Specifications

Enclosure Type:.....A
Weight:42.3 lbs
RF Input/Output:Type N Female

Environmental Specifications

Operating Temp:.....0°C to 50°C
Storage Temp:.....-25°C to 65°C

MPA-2G-6G-100

2-6 GHz, 100W

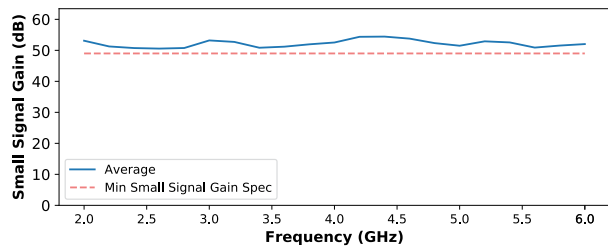
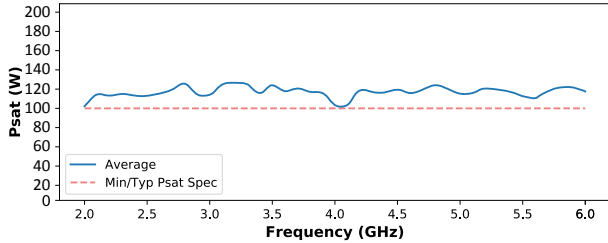

Specifications

Frequency Range:2-6 GHz
 Psat:Typical 100 W, Minimum 100 W
 Input Power:.....Maximum 0 dBm
 Small Signal Gain:Minimum 50 dB
 Gain Flatness:.....Typical ± 2.5 dB
 Gain Adjustment:.....20 dB
 VSWR (Input):.....Maximum 2:1
 2nd Harmonic Power @ Psat:Typical -15 dBc
 Spur @ Psat:.....Typical -65 dBc
 IM3' @ 13 dB back off:Typical -44 dBc
 IM3' @ 3 dB back off:.....Typical -29 dBc
 Unconditionally Stable
 VSWR Load @Psat:3:1
 ECCN:.....EAR99
 Warranty:.....24 months

* 10 MHz Tone spacing

Mechanical Specifications

Enclosure Type:.....A
 Weight:48 lbs
 RF Input/Output:Type N Female

Environmental Specifications

Operating Temp:.....0°C to 50°C
 Storage Temp:.....-25°C to 65°C

MPA-2G-18G-20

2-18 GHz, 20W

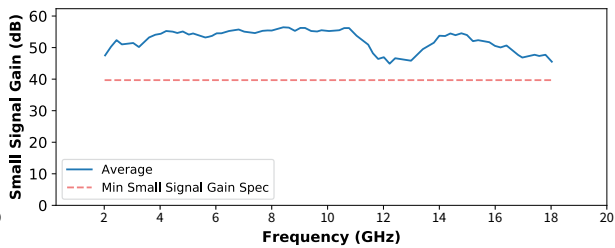
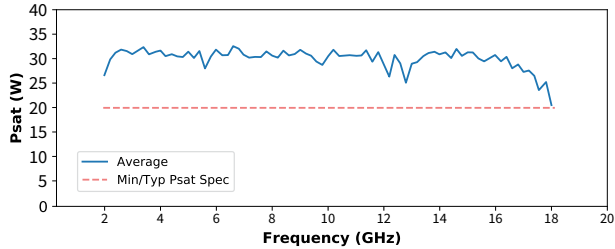

Specifications

Frequency Range:2-18 GHz
Psat:Typical 20 W, Minimum 20 W
Input Power:.....Maximum 5 dBm
Small Signal Gain:Minimum 41 dB
Gain Flatness:.....Typical ± 4 dB
Gain Adjustment:.....20 dB
VSWR (Input):.....Maximum 2:1
2nd Harmonic Power @ Psat:Typical -15 dBc
Spur @ Psat:.....Typical -65 dBc
IM3' @ 13 dB back off:Typical -38 dBc
IM3' @ 3 dB back off:.....Typical -20 dBc
Unconditionally Stable
VSWR Load @Psat:3:1
ECCN:.....EAR99
Warranty:.....24 months

* 10 MHz Tone spacing

Mechanical Specifications

Enclosure Type:.....B
Weight:17.6 lbs
RF Input/Output:SMA Female

Environmental Specifications

Operating Temp:.....0°C to 50°C
Storage Temp:.....-25°C to 65°C

MPA-2G-18G-30

2-18 GHz, 30W

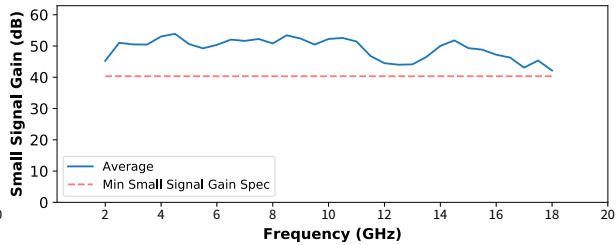
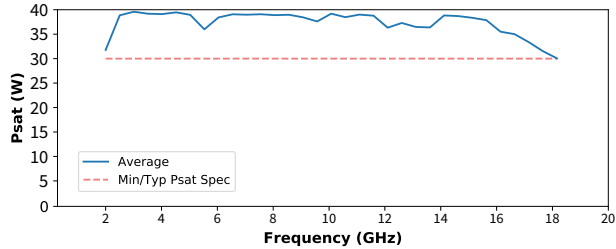

Specifications

Frequency Range:2-18 GHz
 Psat:Minimum 30 W
 Input Power:.....Maximum 5 dBm
 Small Signal Gain:Minimum 47 dB
 Gain Flatness:.....Typical ± 4 dB
 Gain Adjustment:.....20 dB
 VSWR (Input):.....Maximum 2.1:1
 2nd Harmonic Power @ Psat:Typical -15 dBc
 Spur @ Psat:.....Typical -65 dBc
 IM3' @ 13 dB back off:Typical -38 dBc
 IM3' @ 3 dB back off:.....Typical -20 dBc
 Unconditionally Stable
 VSWR Load @Psat:3:1
 ECCN:.....3A001,b4
 Warranty:.....24 months

* 10 MHz Tone spacing

Mechanical Specifications

Enclosure Type:.....A
 Weight:42.3 lbs
 RF Input/Output:SMA Female

Environmental Specifications

Operating Temp:.....0°C to 50°C
 Storage Temp:.....-25°C to 65°C

MPA-2G-18G-50

2-18 GHz, 50W

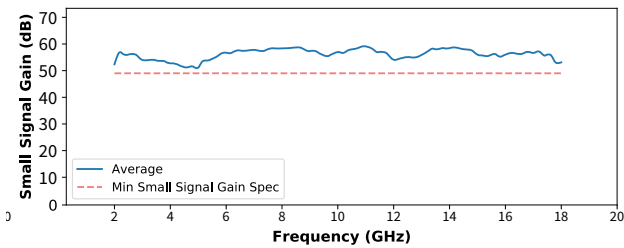
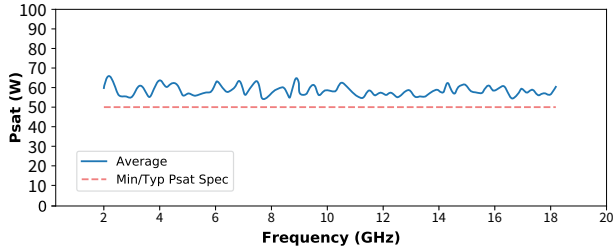

Specifications

Frequency Range:2-18 GHz
 Psat:Typical 50 W, Minimum 50 W
 Input Power:.....Maximum 0 dBm
 Small Signal Gain:Minimum 49 dB
 Gain Flatness:.....Typical ± 4 dB
 Gain Adjustment:.....20 dB
 VSWR (Input):.....Maximum 2.1:1
 2nd Harmonic Power @ Psat:Typical -15 dBc
 Spur @ Psat:.....Typical -65 dBc
 IM3' @ 13 dB back off:Typical -38 dBc
 IM3' @ 3 dB back off:.....Typical -20 dBc
 Unconditionally Stable
 VSWR Load @Psat:3:1
 ECCN:.....3A001,b4
 Warranty:.....24 months

* 10 MHz Tone spacing

Mechanical Specifications

Enclosure Type:.....A
 Weight:48 lbs
 RF Input/Output:Type N Female

Environmental Specifications

Operating Temp:.....0°C to 50°C
 Storage Temp:.....-25°C to 65°C

MPA-6G-18G-10

6-18 GHz, 10W

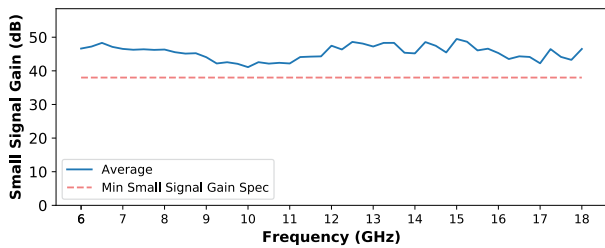
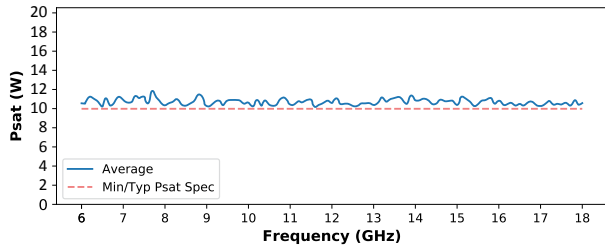

Specifications

Frequency Range:6-18 GHz
 Psat:Typical 10 W, Minimum 10 W
 Input Power:.....Maximum 0 dBm
 Small Signal Gain:Minimum 38 dB
 Gain Flatness:.....Typical ± 3 dB
 Gain Adjustment:.....20 dB
 VSWR (Input):.....Maximum 2:1
 2nd Harmonic Power @ Psat:Typical -15 dBc
 Spur @ Psat:.....Typical -65 dBc
 IM3' @ 13 dB back off:Typical -35 dBc
 IM3' @ 3 dB back off:.....Typical -20 dBc
 Unconditionally Stable
 VSWR Load @Psat:3:1
 ECCN:.....EAR99
 Warranty:.....24 months

** 10 MHz Tone spacing*

Mechanical Specifications

Enclosure Type:.....B
 Weight:20 lbs
 RF Input/Output:SMA Female

Environmental Specifications

Operating Temp:.....0°C to 50°C
 Storage Temp:.....-25°C to 65°C

MPA-6G-18G-20

6-18 GHz, 20W

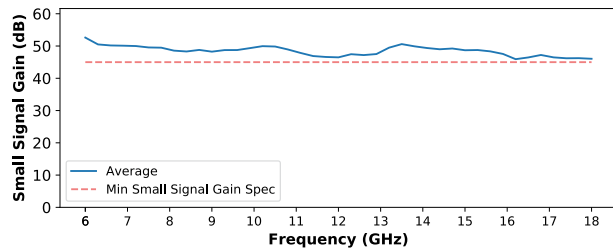
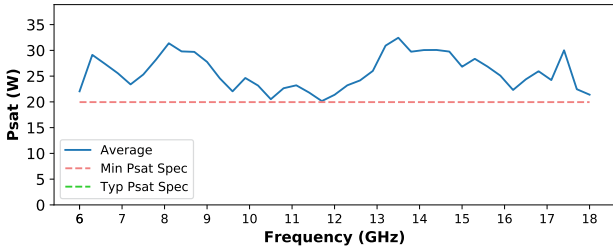

Specifications

Frequency Range:6-18 GHz
 Psat:Minimum 20 W
 Input Power:.....Maximum 5 dBm
 Small Signal Gain:Minimum 45 dB
 Gain Flatness:.....Typical ± 3 dB
 Gain Adjustment:.....20 dB
 VSWR (Input):.....Maximum 2:1
 2nd Harmonic Power @ Psat:Typical -15 dBc
 Spur @ Psat:.....Typical -65 dBc
 IM3' @ 13 dB back off:Typical -35 dBc
 IM3' @ 3 dB back off:.....Typical -20 dBc
 Unconditionally Stable
 VSWR Load @Psat:3:1
 ECCN:.....3A001,b4
 Warranty:.....24 months

* 10 MHz Tone spacing

Mechanical Specifications

Enclosure Type:.....B
 Weight:16.9 lbs
 RF Input/Output:SMA Female

Environmental Specifications

Operating Temp:.....0°C to 50°C
 Storage Temp:.....-25°C to 65°C

MPA-6G-18G-30

6-18 GHz, 30W

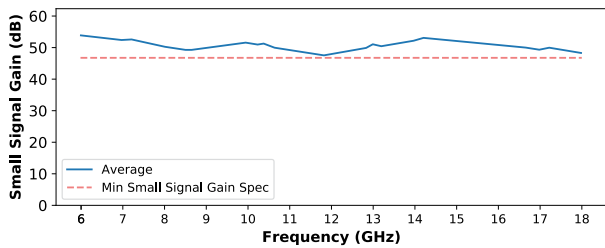
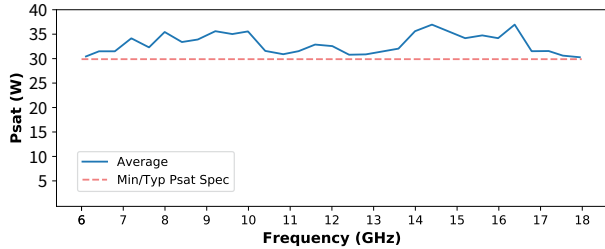

Specifications

Frequency Range:6-18 GHz
 Psat:Typical 30 W, Minimum 30 W
 Input Power:.....Maximum 0 dBm
 Small Signal Gain:Minimum 48 dB
 Gain Flatness:.....Typical ± 3 dB
 Gain Adjustment:.....20 dB
 VSWR (Input):.....Maximum 2:1
 2nd Harmonic Power @ Psat:Typical -15 dBc
 Spur @ Psat:.....Typical -65 dBc
 IM3' @ 13 dB back off:Typical -35 dBc
 IM3' @ 3 dB back off:.....Typical -20 dBc
 Unconditionally Stable
 VSWR Load @Psat:3:1
 ECCN:.....3A001,b4
 Warranty:.....24 months

* 10 MHz Tone spacing

Mechanical Specifications

Enclosure Type:.....A
 Weight:42 lbs
 RF Input/Output:SMA Female

Environmental Specifications

Operating Temp:.....0°C to 50°C
 Storage Temp:.....-25°C to 65°C

MPA-6G-18G-50

6-18 GHz, 50W

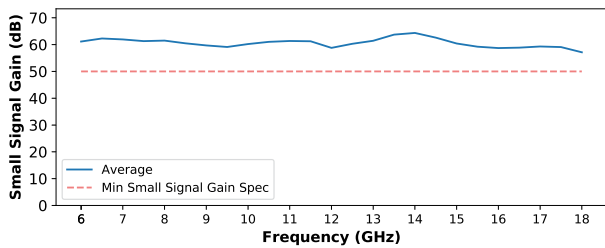
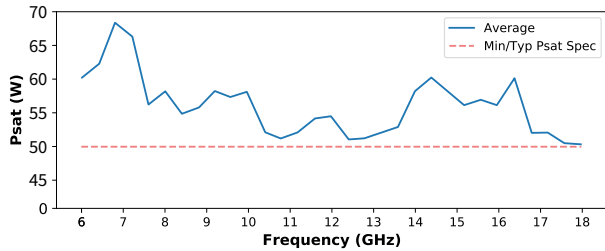

Specifications

Frequency Range:6-18 GHz
 Psat:Minimum 50 W
 Input Power:.....Maximum 3 dBm
 Small Signal Gain:Minimum 50 dB
 Gain Flatness:.....Typical ± 3 dB
 Gain Adjustment:.....20 dB
 VSWR (Input):.....Maximum 2:1
 2nd Harmonic Power @ Psat:Typical -15 dBc
 Spur @ Psat:.....Typical -65 dBc
 IM3' @ 13 dB back off:Typical -37 dBc
 IM3' @ 3 dB back off:.....Typical -20 dBc
 Unconditionally Stable
 VSWR Load @Psat:3:1
 ECCN:.....3A001,b4
 Warranty:.....24 months

** 10 MHz Tone spacing*

Mechanical Specifications

Enclosure Type:.....A
 Weight:42.3 lbs
 RF Input/Output:Type N Female

Environmental Specifications

Operating Temp:.....0°C to 50°C
 Storage Temp:.....-25°C to 65°C

MPA-8G-12G-30

8-12 GHz, 30W

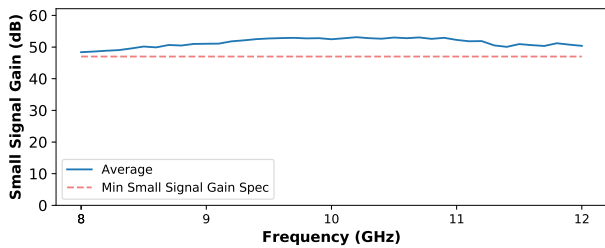
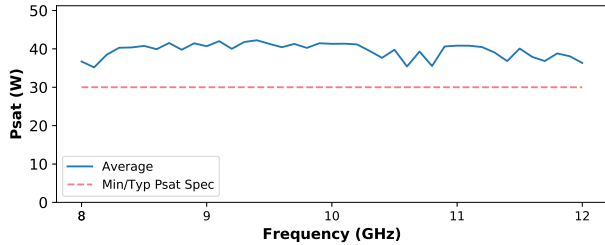

Specifications

Frequency Range:8-12 GHz
 Psat:Typical 30 W, Minimum 30 W
 Input Power:.....Maximum 0 dBm
 Small Signal Gain:Minimum 47 dB
 Gain Flatness:.....Typical ± 3 dB
 Gain Adjustment:.....20 dB
 VSWR (Input):.....Maximum 2:1
 2nd Harmonic Power @ Psat:Typical -35 dBc
 Spur @ Psat:.....Typical -65 dBc
 IM3' @ 13 dB back off:Typical -33 dBc
 IM3' @ 3 dB back off:.....Typical -23 dBc
 Unconditionally Stable
 VSWR Load @Psat:3:1
 ECCN:.....EAR99
 Warranty:.....24 months

** 10 MHz Tone spacing*

Mechanical Specifications

Enclosure Type:.....B
 Weight:22 lbs
 RF Input/Output:SMA Female

Environmental Specifications

Operating Temp:.....0°C to 50°C
 Storage Temp:.....-25°C to 65°C

MPA-8G-12G-50

8-12 GHz, 50W

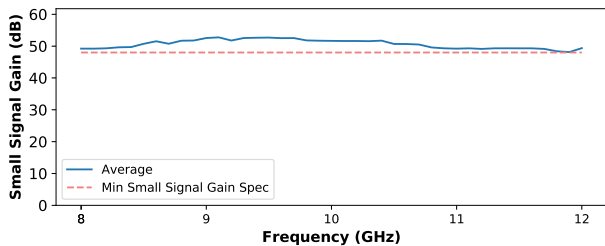
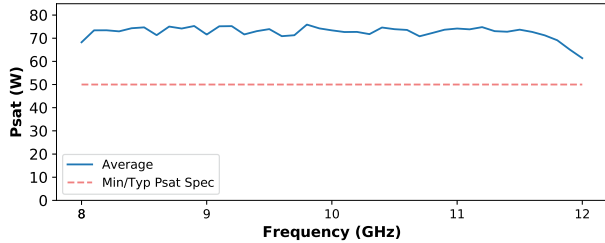

Specifications

Frequency Range:8-12 GHz
 Psat:Typical 50 W, Minimum 50 W
 Input Power:.....Maximum 0 dBm
 Small Signal Gain:Minimum 49 dB
 Gain Flatness:.....Typical ± 3 dB
 Gain Adjustment:.....20 dB
 VSWR (Input):.....Maximum 2:1
 2nd Harmonic Power @ Psat:Typical -35 dBc
 Spur @ Psat:.....Typical -65 dBc
 IM3' @ 13 dB back off:Typical -33 dBc
 IM3' @ 3 dB back off:.....Typical -23 dBc
 Unconditionally Stable
 VSWR Load @Psat:3:1
 ECCN:.....3A001,b4
 Warranty:.....24 months

* 10 MHz Tone spacing

Mechanical Specifications

Enclosure Type:.....A
 Weight:42.3 lbs
 RF Input/Output:Type N Female

Environmental Specifications

Operating Temp:.....0°C to 50°C
 Storage Temp:.....-25°C to 65°C

MPA-18G-26G5-10

18-26.5 GHz, 10W

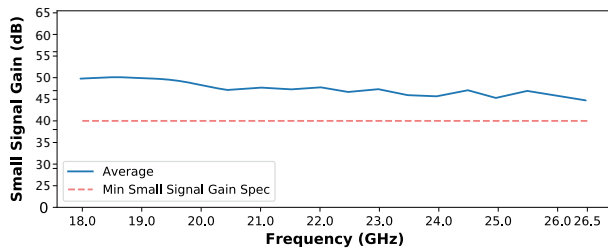
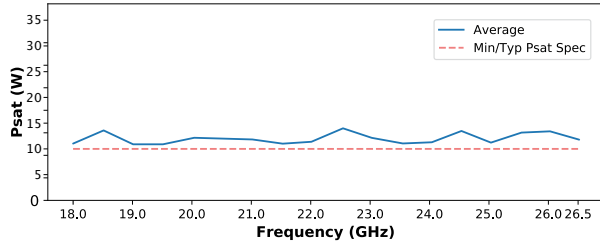

Specifications

Frequency Range:18-26.5 GHz
 Psat:Typical 10 W, Minimum 10 W
 Input Power:.....Maximum 5 dBm
 Small Signal Gain:Minimum 40 dB
 Gain Flatness:.....Typical ± 3 dB
 Gain Adjustment:.....15 dB
 VSWR (Input):.....Maximum 2:1
 Spur @ Psat:.....Typical -65 dBc
 Unconditionally Stable
 VSWR Load @Psat:3:1
 ECCN:EAR99
 Warranty:.....24 months

** 10 MHz Tone spacing*

Mechanical Specifications

Enclosure Type:.....B
 Weight:15.2 lbs
 RF Input/Output:SMA Female

Environmental Specifications

Operating Temp:.....0°C to 50°C
 Storage Temp:.....-25°C to 65°C

MPA-18G-26G5-25

18-26.5 GHz, 25W

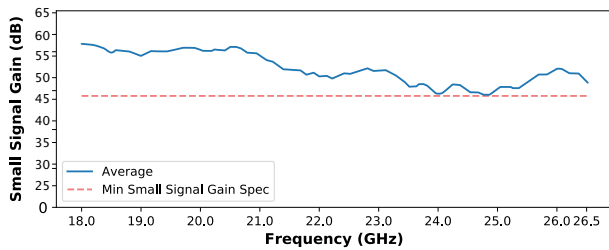
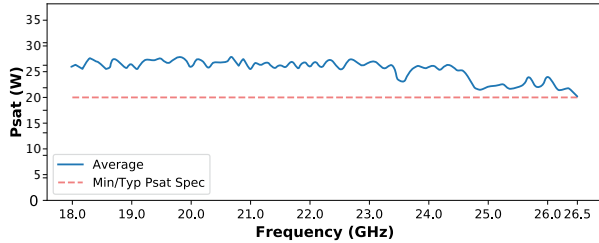

Specifications

Frequency Range:18-26.5 GHz
 Psat:Typical 25 W, Minimum 20 W
 Input Power:.....Maximum 3 dBm
 Small Signal Gain:Minimum 46 dB
 Gain Flatness:.....Typical ± 4 dB
 Gain Adjustment:.....15 dB
 VSWR (Input):.....Maximum 2:1
 Spur @ Psat:.....Typical -65 dBc
 Unconditionally Stable
 VSWR Load @Psat:3:1
 ECCN:3A001.b4
 Warranty:.....24 months

** 10 MHz Tone spacing*

Mechanical Specifications

Enclosure Type:.....A
 Weight:26 lbs
 RF Input/Output:SMA Female/
 WR42

Environmental Specifications

Operating Temp:.....0°C to 50°C
 Storage Temp:.....-25°C to 65°C

MPA-18G-26G5-40

18-26.5 GHz, 40W

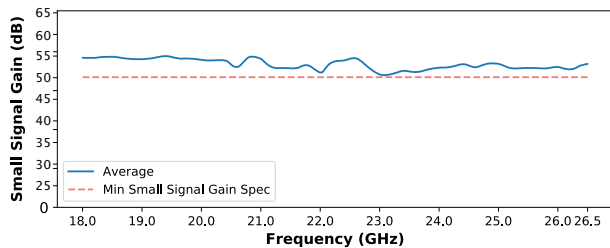
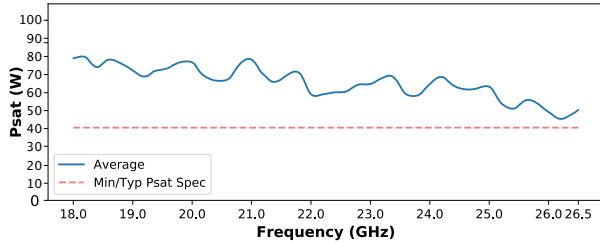

Specifications

Frequency Range:18-26.5 GHz
 Psat:Typical 40 W, Minimum 40 W
 Input Power:.....Maximum 5 dBm
 Small Signal Gain:Minimum 49 dB
 Gain Flatness:.....Typical ± 4 dB
 Gain Adjustment:.....15 dB
 VSWR (Input):.....Maximum 2:1
 Spur @ Psat:.....Typical -65 dBc
 Unconditionally Stable
 VSWR Load @Psat:3:1
 ECCN:3A001.b4
 Warranty:.....24 months

* 10 MHz Tone spacing

Mechanical Specifications

Enclosure Type:.....A
 Weight:48 lbs
 RF Input/Output:SMA Female/
 WR42

Environmental Specifications

Operating Temp:.....0°C to 50°C
 Storage Temp:.....-25°C to 65°C

MPA-26G5-40G-5

26.5-40 GHz, 5W

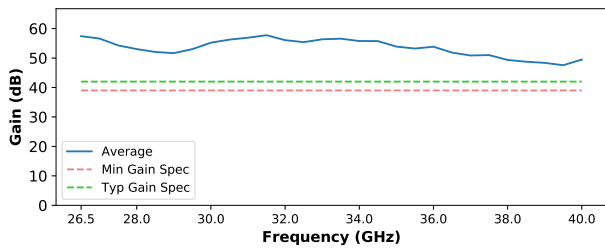
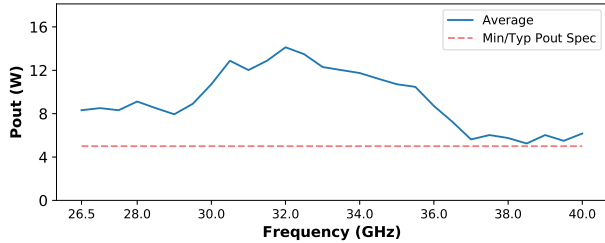

Specifications

Frequency Range:26.5-40 GHz
 Psat:Typical 5 W, Minimum 5 W
 Input Power:.....Maximum 0 dBm
 Small Signal Gain:Minimum 40 dB
 Gain Flatness:.....Typical ± 5 dB
 Gain Adjustment:.....15 dB
 VSWR (Input):.....Maximum 2:1
 Spur @ Psat:.....Typical -65 dBc
 Unconditionally Stable
 VSWR Load @Psat:3:1
 ECCN:.....3A001.b4
 Warranty:.....24 months

Mechanical Specifications

Enclosure Type:.....B
 Weight:16.9 lbs
 RF Input/Output:2.92mm Female

Environmental Specifications

Operating Temp:.....0°C to 50°C
 Storage Temp:.....-25°C to 65°C

MPA-26G5-40G-10

26.5-40 GHz, 10W

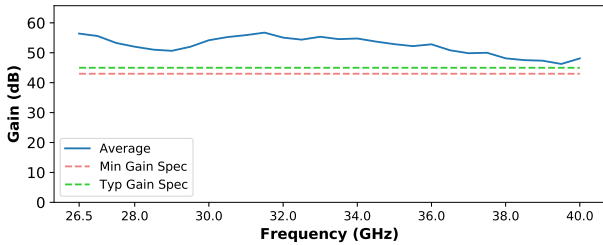
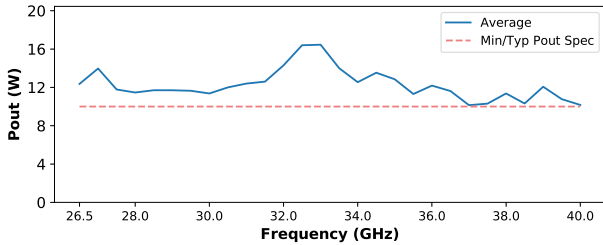

Specifications

Frequency Range:26.5-40 GHz
 Psat:Typical 10 W, Minimum 10 W
 Input Power:.....Maximum 0 dBm
 Small Signal Gain:Minimum 40 dB
 Gain Flatness:.....Typical ± 5 dB
 Gain Adjustment:.....15 dB
 VSWR (Input):.....Maximum 2:1
 Spur @ Psat:.....Typical -65 dBc
 Unconditionally Stable
 VSWR Load @Psat:3:1
 ECCN:3A001.b4
 Warranty:.....24 months

Mechanical Specifications

Enclosure Type:.....B
 Weight:29 lbs
 RF Input/Output:2.92mm Female

Environmental Specifications

Operating Temp:.....0°C to 50°C
 Storage Temp:.....-25°C to 65°C

MPA-26G5-40G-25

26.5-40 GHz, 25W

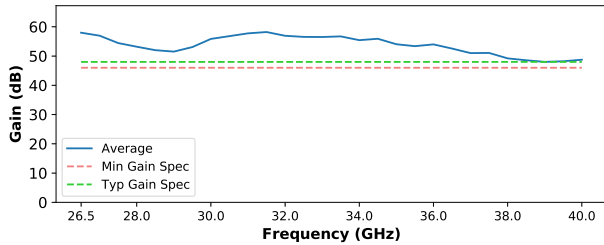
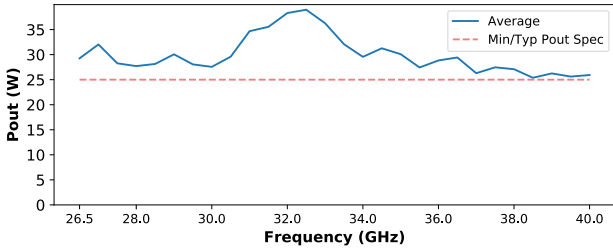

Specifications

Frequency Range:26.5-40 GHz
P_{sat}:Typical 25 W, Minimum 20 W
Input Power:.....Maximum 0 dBm
Small Signal Gain:Minimum 43 dB
Gain Flatness:.....Typical ±5 dB
Gain Adjustment:.....15 dB
VSWR (Input):.....Maximum 2:1
Spur @ P_{sat}:.....Typical -65 dBc
Unconditionally Stable
VSWR Load @P_{sat}:3:1
ECCN:.....3A001.b4
Warranty:.....24 months

Mechanical Specifications

Enclosure Type:.....A
Weight:42.3 lbs
RF Input:.....2.92mm Female
RF Output:.....WR28 flange

Environmental Specifications

Operating Temp:.....0°C to 50°C
Storage Temp:.....-25°C to 65°C

MPA-26G5-40G-40

26.5-40 GHz, 40W

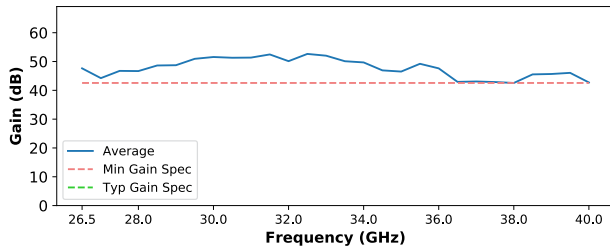
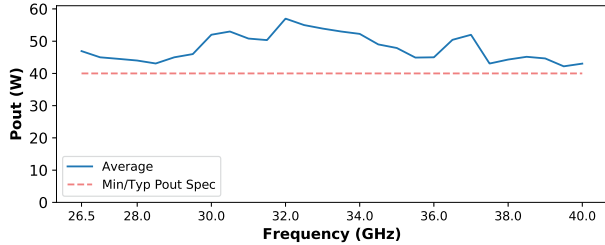

Specifications

Frequency Range:26.5-40 GHz
 Psat:Typical 40 W, Minimum 40 W
 Input Power:.....Maximum 0 dBm
 Small Signal Gain:Minimum 43 dB
 Gain Flatness:.....Typical ± 5 dB
 Gain Adjustment:.....15 dB
 VSWR (Input):.....Maximum 2:1
 Spur @ Psat:.....Typical -65 dBc
 Unconditionally Stable
 VSWR Load @Psat:3:1
 ECCN:.....3A001.b4
 Warranty:.....24 months

Mechanical Specifications

Enclosure Type:.....C
 Weight:59 lbs
 RF Input:.....2.92mm Female
 RF Output:WR28 flange

Environmental Specifications

Operating Temp:.....0°C to 50°C
 Storage Temp:.....-25°C to 65°C

MPA-37G-43G-5

37-43 GHz, 5W

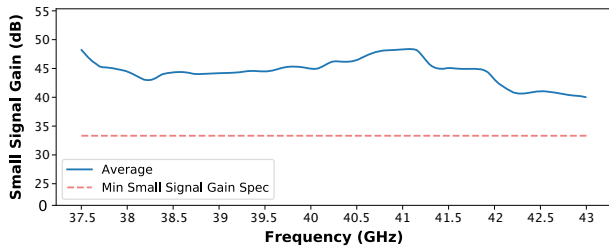
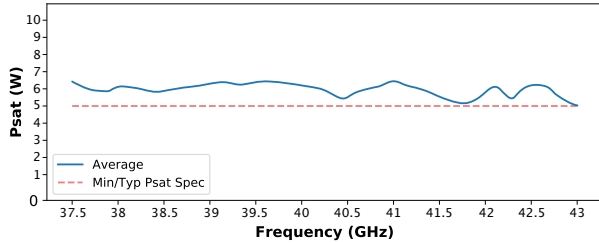

Specifications

Frequency Range:37-43 GHz
Psat:Minimum 5 W
Input Power:.....Maximum 2 dBm
Small Signal Gain:Minimum 33 dB
Gain Flatness:.....Typical ± 4 dB
Gain Adjustment:.....15 dB
VSWR (Input):.....Maximum 2:1
Spur @ Psat:.....Typical -65 dBc
Unconditionally Stable
VSWR Load @Psat:3:1
ECCN:3A001.b4
Warranty:.....24 months

Mechanical Specifications

Enclosure Type:.....B
Weight:14.33 lbs
RF Input/Output:2.4mm Female

Environmental Specifications

Operating Temp:.....0°C to 50°C
Storage Temp:.....-25°C to 65°C

A

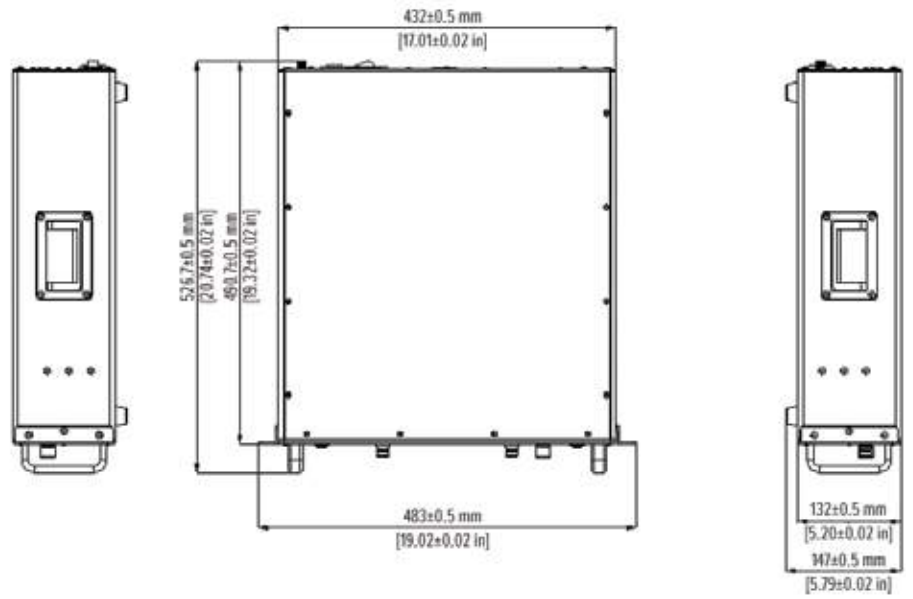

B

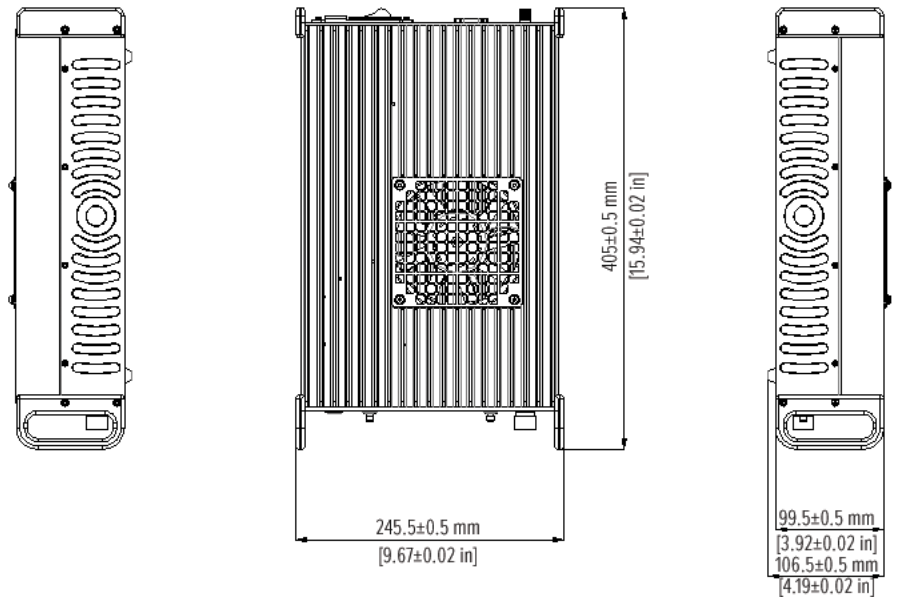

C

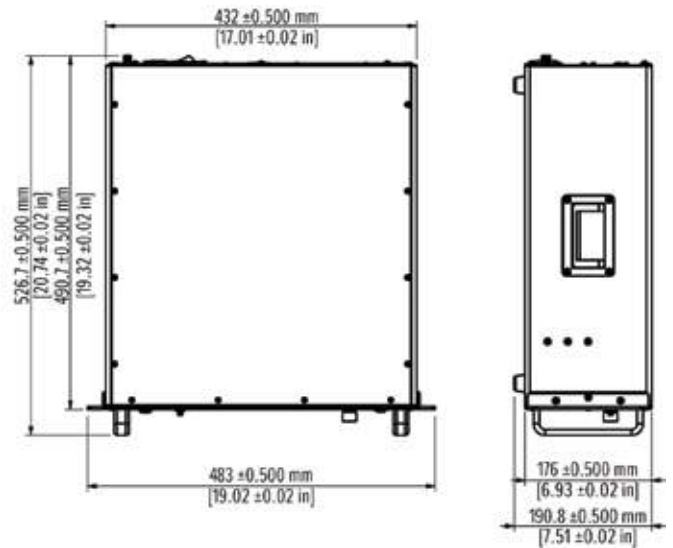

Maximizing Up-Time

All MPA-series amplifiers go through an extensive burn-in and ageing process to ensure high reliability and maximize up-time. We do recognize that, however unlikely, problems tend to arise at the most inconvenient moments, often when measurement systems are in the highest demand.

As a courtesy to our customers, Maury retains a pool of common amplifiers which can be used during the repair process. The frequencies and powers of the amplifiers offered as part of the courtesy pool may vary from time to time and are subject to availability.

Beyond our courtesy pool, we offer service level agreements (SLA) that include dedicated backup amplifiers to ensure availability during the warranty period and are shipped within two business days of notice. With an SLA, we can maximize up-time and ensure systems are available for use.

Please inquire with your Maury Sales contact for details.

Semi-Custom and Custom Amplifiers

Semi-Custom and Custom Amplifiers

Not finding what you need in our standard offering? Maury offers semi-custom and custom amplifiers to meet your application requirements.

Semi-Custom Amplifiers

Looking for something not-quite “off-the-shelf”? Do you need a little more power? A slightly different frequency band? A bit more gain? Maury’s semi-custom amplifiers may be just what you need. We will modify our standard amplifiers to meet your application needs while maintaining all the benefits of our standard offering. Contact Maury Sales and we’ll work on delivering a solution that upgrades your test bench to “State-of-the-Art”.

Custom Amplifiers

Looking for something even more specialized? Maury can go beyond modifying our standard “off-the-shelf” amplifiers and customize a solution for your unique application, including:

- > Electrical: frequency range, output power, gain, harmonic power, spurious signals levels, intermodulation levels, noise floor...
- > Protection and indications: LCD display, over-current protection, over-heat protection...
- > Mechanical and environmental: connectors and positioning, cooling, temperature range, dimensions....

Please complete a Custom Amplifier Questionnaire; we will compare your requirements with our capabilities and determine whether we can assist with your custom requirements.

Note: all custom amplifiers requests are evaluated on a case-by-case basis; completing a questionnaire does not ensure Maury will be able to offer an amplifier to meet your requirements; all custom amplifiers will include comprehensive Terms and Conditions (T&C) and will be accompanied by a set of Acceptance Test criteria (ATP).

Specifications Definitions

| Parameter | Extended Parameter (if required) | Description and/or Usefulness of Parameter | Notes | Units |
|-------------------|--|--|--|-------|
| Psat | Saturated Output Power | Defines the maximum output power that can be sustained without any damage or long term reliability issues. | Psat is achieved once an increment of 1dB input power results in an increased output power less than 0.2dB | dBm |
| Input Power | | Defines the maximum input power that can be injected into the amplifier without any damage or long term reliability issues. | | dBm |
| Small Signal Gain | | Defines the difference between the output power and input power under small signal conditions. Specification allows a user to budget the required input power in order to reach the desired output power. | Power Gain measured under 50ohm conditions with a -30dBm input signal | dB |
| Gain Flatness | Gain Flatness as a Function of Frequency | Defines the maximum deviation of Gain over the frequency range of the amplifier. May be an important consideration for wideband power measurements. | Small Signal Gain variation vs frequency at -30dBm input power | dB |
| Gain Adjustment | | Defines the range of gain achievable by varying the position of the gain knob. May be an important consideration for measurements which require less gain than maximum, or require a level of gain variability during the measurement. | The lowest achievable Gain is equal to the average Small Signal Gain minus Gain adjustment. | dB |
| VSWR (input) | Input Voltage Standing Wave Ratio | Defines maximum Input VSWR; a low VSWR ensures sufficient signal transmission between signal generator and amplifier. | VSWR measured with a VNA under small signal conditions (-30dBm input power) | |
| Harmonic Power | | Defines relative power at harmonic frequencies compared with the power at the fundamental frequency. May be important for applications where injecting harmonic powers created by the amplifier may alter DUT performance or invalidate measurement results. | Power at the harmonic frequencies are measured while the power at the fundamental frequency is set to typical Psat. $P_{2H} = P_{210} - P_{10}$ $P_{3H} = P_{310} - P_{10}$ | dBc |

| | | | | |
|---|---|---|--|-----|
| Spur | Spurious Signals | Defines relative power at non-harmonic frequencies compared with the power at the fundamental frequency. May be important when measuring the stability of a DUT and oscillations. | Power at non-harmonic frequencies are measured while the power at the fundamental frequency is set to typical Psat. | dBc |
| IM3 @13dB back-off and IM3 @3dB back-off | Third-Order Intermodulation Product | Defines the relative power at intermodulation frequencies for a multi-tone source signal. May be an important consideration for the accurate measurement of DUT linearity performance. | Power at the high and low-third order intermodulation product frequencies are measured while the power at the carrier frequencies with 10 MHz offset are set to 13dB and 3dB back-off from typical Psat. $IM3_L = P_{2f1-f2} - P_{f1}$ $IM3_H = P_{2f2-f1} - P_{f2}$ | dBc |
| Unconditionally Stable | Unconditionally Stable with K>1 | An unconditionally stable amplifier will not oscillate regardless of the impedance presented to it. | K-factor is calculated using S-parameters with a -30dBm input signal | |
| VSWR Load @Psat | Load Voltage Standing Wave Ratio Tolerance at Output Port | Defines maximum Output VSWR which can be presented to the amplifier on RF output port without reflecting a large power which could potentially damage the amplifier. This parameter is specified at typical Psat. | Placing an isolator/circulator on the output port is a best-practice and increases the protection of the amplifier significantly | |

Parameters

Parameters may be rated as typical, minimum or maximum based on the following definitions:

- > **Typical (typ):** the actual value will be greater than or equal to the typical specification over 80% of the frequency range.
- > **Minimum (min):** the actual value will be greater than or equal to the minimum specification over 100% of the frequency range.
- > **Maximum (max):** the actual value will be less than or equal to the maximum specification for 100% of the frequency range.

Measurement & Modeling Device Characterization Solutions





— MEASUREMENT & MODELING DEVICE CHARACTERIZATION SOLUTIONS

IVCAD Advanced Measurement & Modeling Software

Powered by

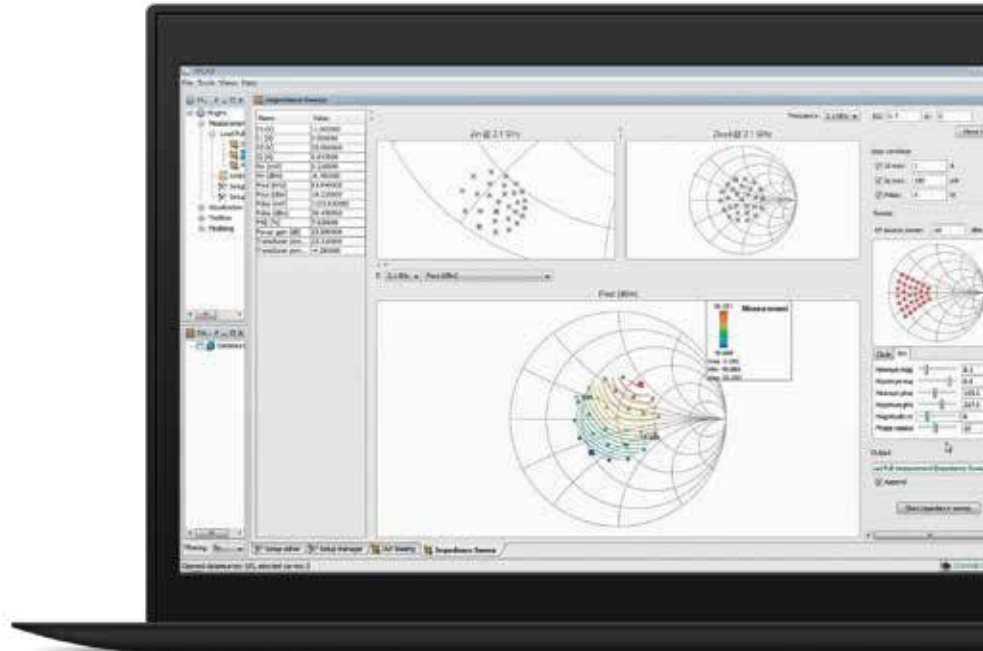

MT930 Series

Maury IVCAD Software Completes the Cycle from Pulsed-IV and S-Parameters, to Harmonic Load Pull, to Compact Transistor Models!

Introduction

IVCAD advanced measurement and modeling software, offered by Maury Microwave and AMCAD Engineering supports multiple load pull techniques including traditional load pull using external instrumentation, VNA-based load pull, active load pull and hybrid load pull. It performs DC-IV and pulsed-IV measurements and incorporates device modeling tools. Its modern visualization capabilities give users a greater ability to view, plot and graph measurement data in an intuitive manner.

IVCAD Software Suite Models

- MT930B1 – IVCAD Basic Visualization
- MT930B2 – IVCAD Advanced Visualization Add-On
- MT930C – IVCAD Vector-Receiver Load Pull
- MT930D1 – IVCAD Traditional Load Pull
- MT930D2 – IVCAD Harmonic, Spectrum and Vector Analyzer Add-On
- MT930E – IVCAD DC-IV Curves
- MT930F – IVCAD CW S-Parameters
- MT930GA – IVCAD Time-Domain LSA Add-On
- MT930GB – IVCAD Keysight NVNA Support Add-On
- MT930H – IVCAD Active Load Pull
- MT930J – IVCAD Pulsed IV Curves
- MT930K – IVCAD Pulsed S-Parameters
- MT930L – IVCAD Scripting Language
- MT930M1 – IVCAD Linear Model Extraction
- MT930M2A – IVCAD Nonlinear Model Extraction, III-V
- MT930M2B – IVCAD Nonlinear Model Extraction, LDMOS
- MT930P – IVCAD Measurement Toolbox
- MT930Q – IVCAD Stability Analysis Tool (STAN)
- MT930R1 – IVCAD EPHD Behavioral Model Extraction



DATA SHEET
4T-022

Advanced Measurement & Modeling

The consolidation of industry players and an overall reduction in acceptable time-to-market has led to a demand for streamlined and efficient measurement and modeling device characterization tools. Maury Microwave, along with strategic partner AMCAD Engineering, have succeeded in this challenge by releasing its IVCAD measurement and modeling device characterization software, the most complete commercial solution to cover the design flow from component to circuit to system.

Pulsed IV, Pulsed RF and Compact Transistor Modeling (III-V and LDMOS)

The design flow begins with component-level linear and nonlinear model extraction of popular transistor technologies such as GaN FET and LDMOS.

First, IVCAD, in conjunction with a BILT pulsed-IV system and pulsed-network analyzer will measure synchronized pulsed-IV and pulsed S-parameter data under varying gate and drain bias conditions. Specific pulse widths will be set in order to eliminate self-heating and operate the transistor under quasi-isothermal conditions. The quiescent gate and drain voltages will be set to isolate and model gate-lag and drain-lag trapping phenomena. Measurements

can be repeated under varying chuck temperatures, varying pulse widths and quiescent bias points, to extract an electrothermal model component.

AMCAD III-V and LDMOS model extraction is performed within the IVCAD platform; the same tool used to record relevant measurements is also used to extract the complete compact model. The measured S-parameters are used to extract a linear model consisting of extrinsic (pad capacitances, port metallization inductances, port ohmic resistances) and intrinsic parameters (channel capacitances, ohmic resistances, mutual inductance, output capacitance and resistance). Synchronized pulsed IV and pulsed S-parameter are used to extract nonlinear capacitances, voltage controlled output current source, diodes, breakdown generator, thermal and trapping circuits.

Load Pull (Vector-Receiver and Traditional)

Load pull involves varying the load impedance presented to a device-under-test (DUT) at one or more frequencies and measuring its performance, including output power at the fundamental and harmonic frequencies, gain, efficiency, intermodulation distortion... Load pull can be used for amplifier design, model extraction, model validation, performance testing as function of mismatch, and to test the robustness of finished systems, among other things.

Once a nonlinear compact model has been extracted, load pull can be used for model refinement by adjusting nonlinear parameters to better match the nonlinear measurements. Load pull can also be used for model validation by overlaying simulated and measured transistor performance as a function of load impedance presented to the transistor.

IVCAD supports multiple forms of traditional (scalar, modulated) and vector-receiver (VNA-based, real-time) load pull methodologies. Traditional load pull includes CW and pulsed-CW single-tone and two-tone, as well as modulated input signals, fundamental and harmonic impedance control on the source and load, passive impedance generation techniques, under DC and pulsed bias stimulus. Vector-receiver load pull includes CW and pulsed-CW single-tone and two-tone input signals, fundamental and harmonic impedance control on the source and load, passive, active and hybrid-active impedance generation techniques, time-domain waveform NVNA load pull, under DC and pulsed bias stimulus.

Passive load pull allows engineers to use mechanical impedance tuners to vary the source and load impedance presented to the DUT. Passive load pull is available at the fundamental and harmonic frequencies.



Active load pull replaces passive tuners at one or more frequencies with “active tuners”, which use a magnitude and phase controllable source to inject power into the output of the DUT, thereby creating the “reflection” signal needed to vary the impedance presented. Active load pull overcomes the mechanical and VSWR challenges presented by harmonic passive tuners, as well as tuning isolation challenges between the different frequencies related to the combined movement of the tuner’s slugs.

Hybrid-active load pull combines the strengths of active and passive load pull, allowing the passive tuner to act as a prematch, to lower the power required by the “active tuner”, and divide-and-conquer multiple frequencies.

Time-domain NVNA load pull allows for the recording of voltage and current waveforms and load lines in addition to the typical measurement parameters. This additional information can be useful in studying the sensitivity of a transistor as well as class of operation.

Synchronized pulsed-RF pulsed-bias load pull uses the BILT PIV system to bias the DUT for a true pulsed measurement. Pulsing the bias can set the thermal state of the transistor and avoid self-heating. It is also useful to MMIC applications in which the bias will be pulsed.

Behavioral Modeling

Behavioral modeling is a “black-box” modeling technique which models the DUT’s response to a specific set of stimuli (input power, bias, impedance...). Compared with compact models which completely define the characteristics of the transistor, behavioral models define only the “behavior” and static models are

valid under the conditions in which they were extracted. Behavioral models are useful in several applications: to hide the details of the transistor specifics while concentrating on its performance and response (ideal for public distribution), to improve the speed of simulation (behavioral models will generally simulate faster than a compact model containing the same data), to model a packaged component, or even a complete circuit or system (incompatible with compact modeling).

IVCAD supports three behavioral modeling methodologies: Keysight’s X-Parameters and AMCAD’s Multi-Harmonic Volterra (MHV) and Enhanced PHD. X-Parameters are the result of poly-harmonic distortion methodology (harmonic superposition) which uses harmonic extraction tones to quantify the harmonic nonlinearities of a DUT. The MHV modeling technique is based on harmonic superposition combined with dynamic Volterra theory resulting in a model that can handle both low frequency and high frequency memory effects. The strength of MHV modeling is that it enables accurate and reliable simulations in commercial RF circuit or system simulators, even when using complex modulated wideband signals. Thanks to this accuracy, the most important figures of merit of RF systems can be analyzed safely (e.g., EVM, ACPR, IM3, etc.).

Enhanced PHD (EPHD) is ideal for behavioral modeling of amplifiers in which extrapolation of loading conditions may be required beyond those used in the modeling extraction process. Behavioral modeling within IVCAD is transparent to the user. Sweep plans (impedances, power, bias...) are

defined and the measurement is run as normal, however the software will communicate with the relevant model extraction application and present a completed model upon completion of the measurement routine.

Stability Analysis of Circuits

Once an amplifier or integrated circuit has been designed on a circuit simulator, it is critical to test the design for low- and high-frequency oscillations. IVCAD offers a Stability Analysis module (STAN) which is compatible with commercial circuit simulation tools. Single-node and multi-node analysis identifies the cause and localization of oscillations. Parametric analysis determines oscillations as a function of varying input power, bias, load impedance and stabilization network parameters (resistance values). Monte Carlo analysis discovers oscillations as a function of manufacturing dispersions and tolerances.

Whether being used for a single purpose or across multiple modeling, design and production groups, IVCAD measurement and modeling device characterization software suite offers an intuitive, methodical and efficient solution for first-pass design success and quickest time to market.

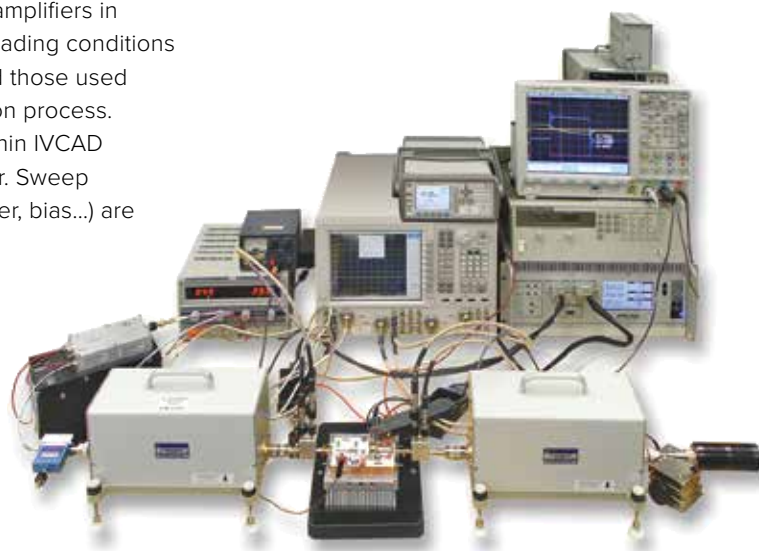

MT930B1 IVCAD Basic Visualization

IVCAD offers a modern and intuitive basic visualization package for IV, S-Parameters and Load Pull data.

- > Basic I(V) Viewer plots IV curves of Vd, Vg, Id and Ig
- > IV Trace Viewer
- > Basic S Parameter Viewer plots S-parameters in standard and custom formats including log magnitude, linear magnitude, phase, polar, and Smith Chart
- > Basic Load Pull Viewer plots impedance sweeps and power sweeps with advanced filtering capabilities

Dockable windows allow users to create and save custom IVCAD environments. Templates allow users to save their preferred visualization graphs and recall or share with colleagues. Data Editor allows users to create new parameters based on equations and visualize alongside measurement data. Export allows users to save graphs and plots as JPG or PDF files for reporting. Visualization is compatible with Maury Microwave and common commercial data formats.

*Visualization of
S-Parameters,
IV Curves, Pulse
Shape and
3D Load Pull
Contour*

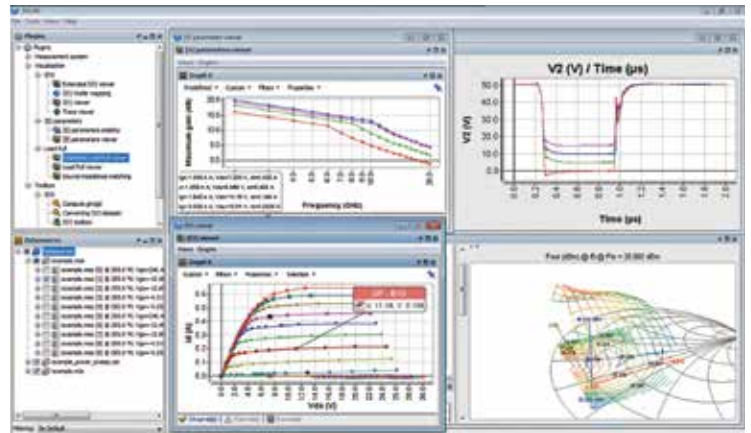

MT930B2 IVCAD Advanced Visualization Add-On

MT930B2 is an add-on module for MT930B1 which enables advanced visualization capabilities including:

- > Extended IV Viewer
- > I(V) Wafer Mapping
- > S parameter stability analysis
- > Extended Load Pull Viewer
- > Load Pull time domain visualization
- > Magic Source Pull

Extended IV Viewer – enables users to visualize a transistor's pulsed IV characteristics versus time. This is useful in observing dynamic self-heating in the saturated region while moving different time markers. A second use is to determine the ideal measurement windows, i.e. the steady-state measurement area, so that the measurement data is not recorded in an area of overshoot or ringing. This is critical in defining the minimum pulse width for any given measurement, since the ideal value is tied to transistor size, bias tees, cables, etc, and can only be determined by visualizing the shape of the pulse over time.

I(V) Wafer Mapping – makes use of IVCAD's automated probe station control for step-and-repeat IV measurements and plots critical IV characteristics as a function of transistor over the wafer. DC G_m and G_d characteristics can be dynamically observed, as well as Gate Lag and Drain Lag over the wafer.

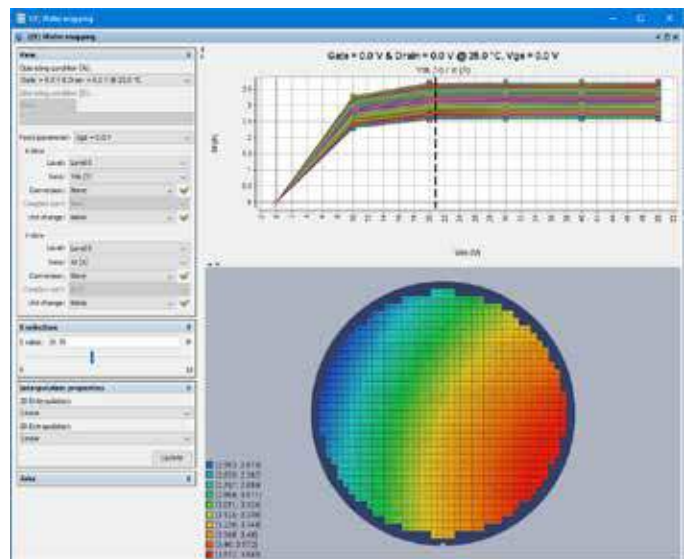

S-parameter stability analysis – allows users to visualize source and load stability circles extracted from linear S parameter measurements. Constant available gain and operating gain circles are also plotted and updated in real-time as a function of frequency.

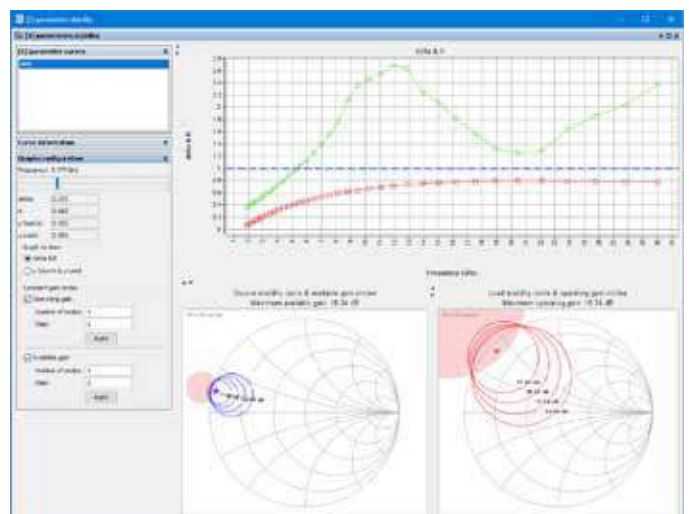

Extended Load Pull viewer – enables users to dynamically plot XY graphs and Smith Chart contours based on a dependency variable, such as input power, output power, gain compression, efficiency or EVM. The viewer links two independent plots, such that the first plot is used to determine the dependency value, while the second plot is automatically updated as a function of the dependency value, and can be customized on the fly. Extended Load Pull viewer is invaluable when sorting through large sets of measurement data, such as nested measurements (i.e. load pull over a region of the Smith Chart, while sweeping power at each load).

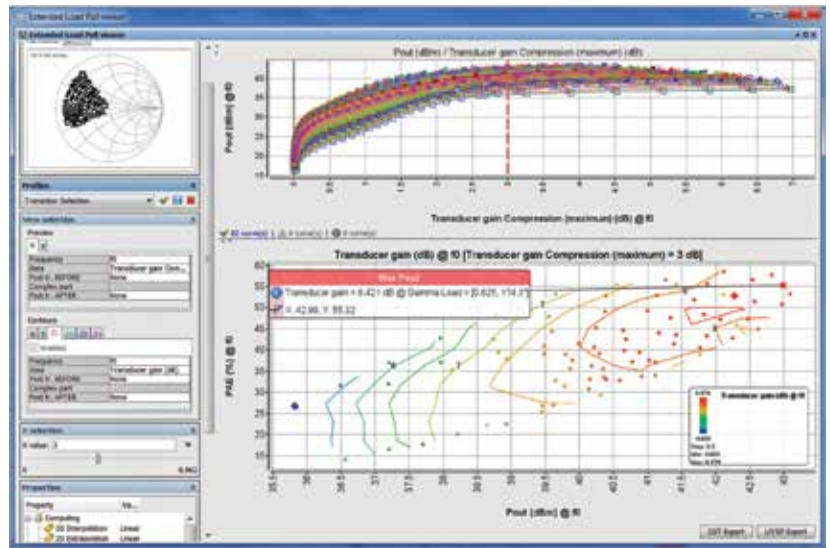

Load Pull Time Domain visualization – enables the plotting of voltage and current waveforms and load lines measured using the MT930G IVCAD Time-Domain Waveforms add-on module for MT930C IVCAD Vector-Receiver Load Pull. In addition, linear models extracted using MT930M1 IVCAD Linear Model Extraction can be used to de-embed the time-domain waveforms to the intrinsic transistor reference plane, and intrinsic RF load lines can be superimposed with Pulsed IV plots to give valued information regarding high efficiency operating classes (i.e. Class F, Inverse Class F...). Markers can be placed at different powers to visualize the effects of gain compressions on load line saturation.

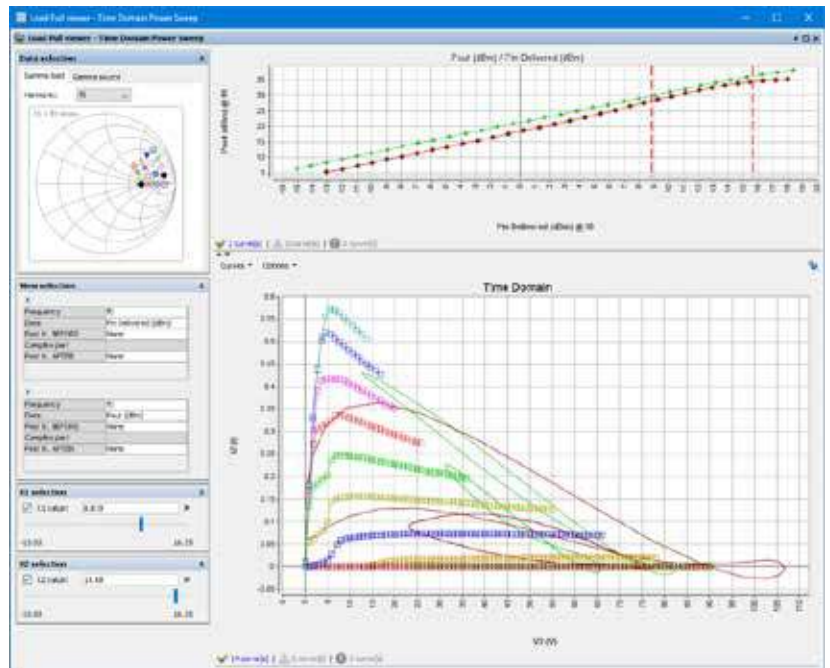

Magic Source Pull (Source Pull Converter) – Large signal input impedance can be found by measuring DUT a- and b-waves at the DUT reference plane. A patented technique simulates source matching, without varying the source impedance. Even under extremely mismatched conditions this “virtual source matching” is highly reliable, provided the DUT is sufficiently unilateral ($S_{21} \gg S_{12} + 50\text{dB}$). Simulated source contours are drawn, and trade-offs between maximum gain, efficiency and other parameters can be viewed in real-time without multiple source-load measurement iterations. Direct computation of the input VSWR versus source power and source impedance is also enabled.

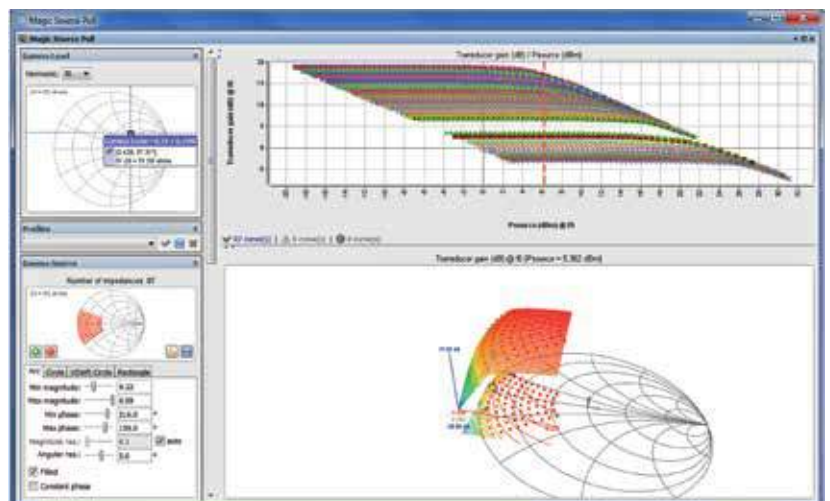

MT930C IVCAD Vector-Receiver Load Pull

IVCAD offers a modern, efficient methodology for load pull measurements, with low-loss couplers between the tuners and DUT. Connecting the couplers to a VNA allows real-time measurement of a- and b-waves at the DUT reference plane, presenting vector information not normally made available. IVCAD measures the actual impedances presented to the DUT without assumptions of pre-characterized tuner positioning or losses. Extremely accurate transistor's input impedance derived from the a- and b-waves results in properly-defined delivered input power, true power added efficiency and true power gain measurements. Output powers at each frequency, fundamental and multiple harmonics, are made available as are multi-tone carrier and intermodulation powers.

Key Features:

- > Supports single-tone and two-tone CW and pulsed-CW drive signals
- > Fundamental and harmonic impedance control on source and load
- > Automatically measures and calculates available parameters based on instrumentation
- > DC and pulsed bias with interactive bias control
- > Measure Z_{in} in real-time to determine $P_{in,delivered}$
- > Automatically tune the source tuner to the complex conjugate match of Z_{in} for maximum power delivered to the DUT
- > Measure actual Z_l load impedances presented to DUT
- > Two-tone IMD load pull using PNA-X
- > Automatically de-embed and correct S-parameters of components between tuner and DUT
- > Advanced peak search algorithm determines the region of maximum performance
- > Real-time visualization of load contours and power sweeps
- > Integrate VRLP and TLP in one setup
- > Export data to CSV or MDF

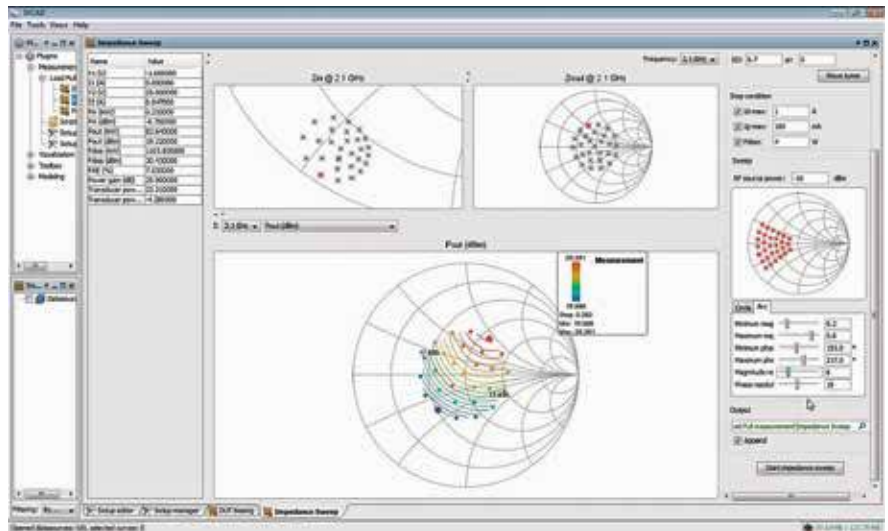

Impedance Sweep at Fixed Power

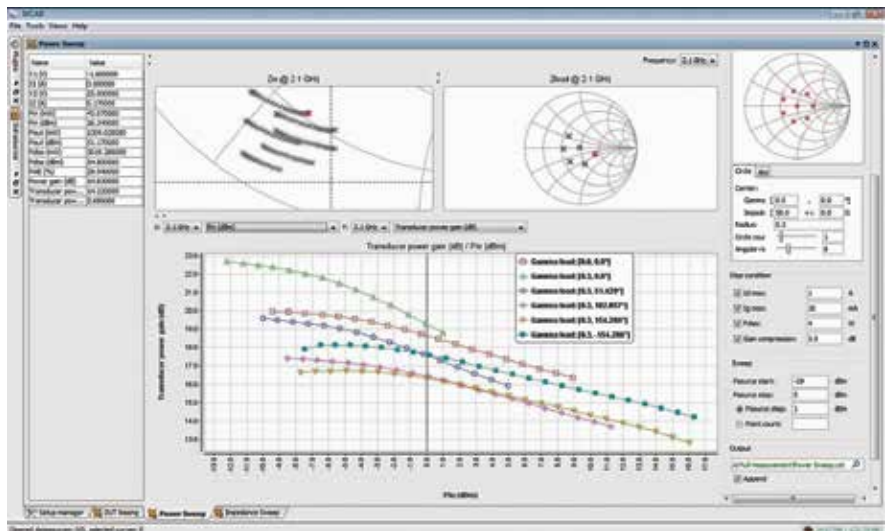

Power Sweep at Multiple Impedances

Advanced Sweep Plan – available with both MT930C and MT930D1; by performing sweeps at multiple impedances, sufficient data is gathered that target parameters can be changed post-measurement without the need for additional measurement iterations. The same data set can be used to plot selected parameters at a constant input power, parameters at a constant output power, and parameters at constant compression level. This process greatly reduces total measurement time by gathering sufficient data first-pass, and shifting capabilities towards data visualization and analysis. Sweep parameters include DUT biasing, probe map, impedance sweep, frequency sweep, and power Sweep. Advanced capabilities include changing setup File, measurement configuration, output File During Sweep and stop conditions throughout the plan, as well as adding nestable loops, wait times and messages.

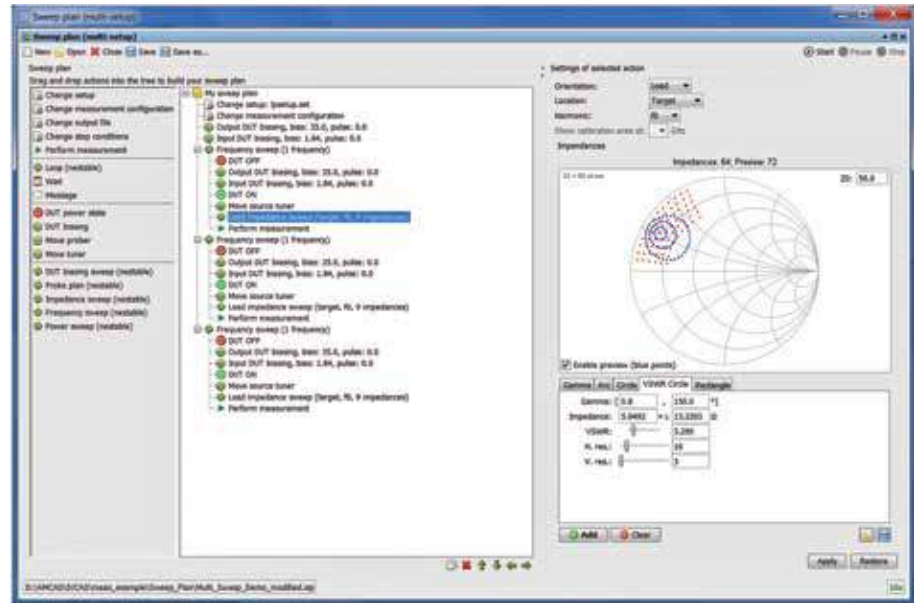

Advanced Sweep Plan Varying Bias, Impedance and Power

MT930D1 Traditional Load Pull and MT930D2 Harmonic, Spectrum and Vector Analyzer Add-On

IVCAD offers a flexible solution for traditional load pull based on power meters and optional spectrum or vector signal analyzers. In its simplest configuration, IVCAD can use a single signal source and power meter to measure power, gain, and efficiency. Adding an optional second power meter will enable input signal monitoring or reflection power measurements, or powers at harmonically separated frequencies when combined with a multiplexer. Adding an optional spectrum

analyzer will enable the measurement of power at fundamental and harmonic frequencies. Adding an optional second source and spectrum analyzer will enable the measurement of two-tone IMD products. Adding an optional vector signal source and vector spectrum analyzer will enable the measurement of ACPR and EVM for modulated signals. IVCAD uniquely enables multiple calibration techniques including S-parameter calibration and power calibration with and without input power meters.

MT930D1 – includes CW and pulsed-CW single tone load pull using a power meter to measure output power

MT930D2 – is an add-on module for MT930D1 and enables the addition of a multiplexer with multiple power meters for harmonic power measurements, a spectrum analyzer for harmonic power measurements and two-tone IMD measurements (when paired with a second or two-tone signal source), a vector analyzer for modulated signal measurements of ACPR and EVM (when paired with a vector signal generator), and harmonic load pull (when paired with compatible impedance tuners.)

Advanced Sweep Plan – See Advanced Sweep Plan description in MT930C.

Key Features

- > Supports single-tone and two-tone CW and pulsed-CW and modulated drive signals
- > Fundamental and harmonic impedance control on source and load
- > Automatically measures and calculates available parameters based on instrumentation
- > DC and pulsed bias with interactive bias control
- > S-parameter and power calibration methodologies
- > Harmonic load pull using power meters or spectrum analyzers
- > Two-tone IMD load pull using spectrum analyzers
- > Modulated load pull using vector analyzers
- > Real-time visualization of load contours and power sweeps
- > Integrate VRLP and TLP in one setup
- > Export data to CSV or MDF

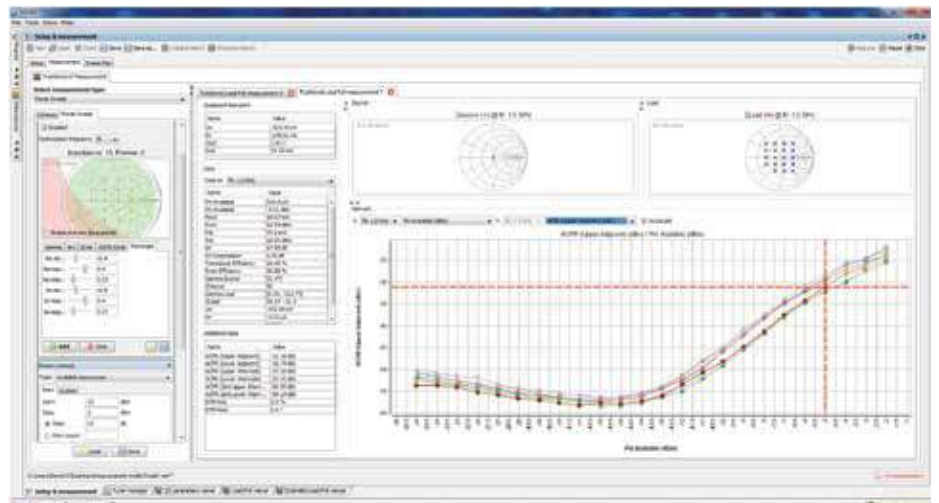
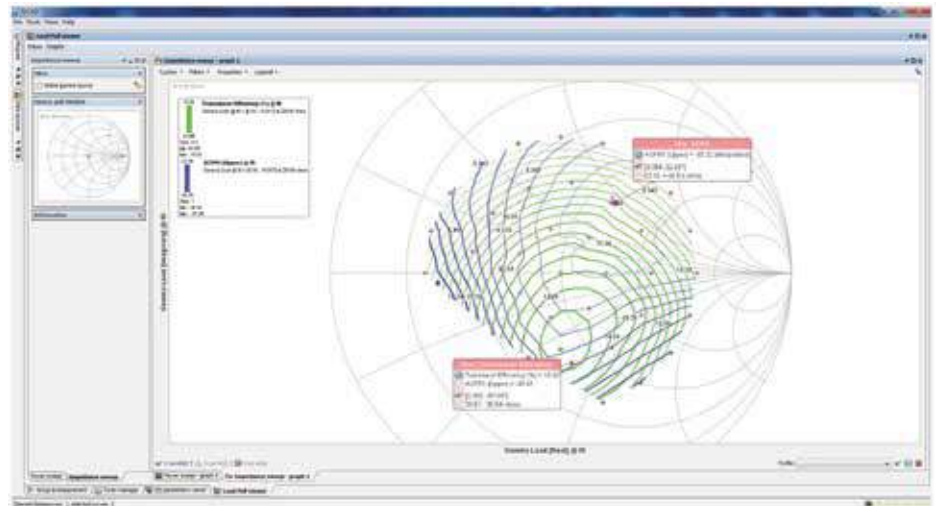

MT930E IVCAD IV Curves

MT930E is a standalone module which enables DC-IV curves to be generated for a list of drain and gate voltages.

MT930F IVCAD CW S-Parameters

MT930F is an add-on module for MT930E which enables CW S-parameters to be measured at each DC IV bias point.

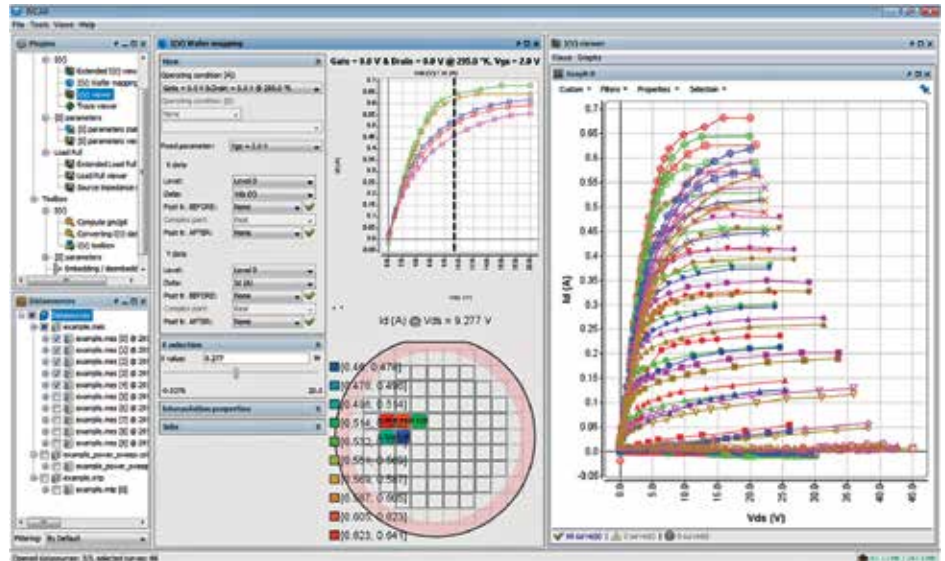

IV Curves at Various Wafer Positions

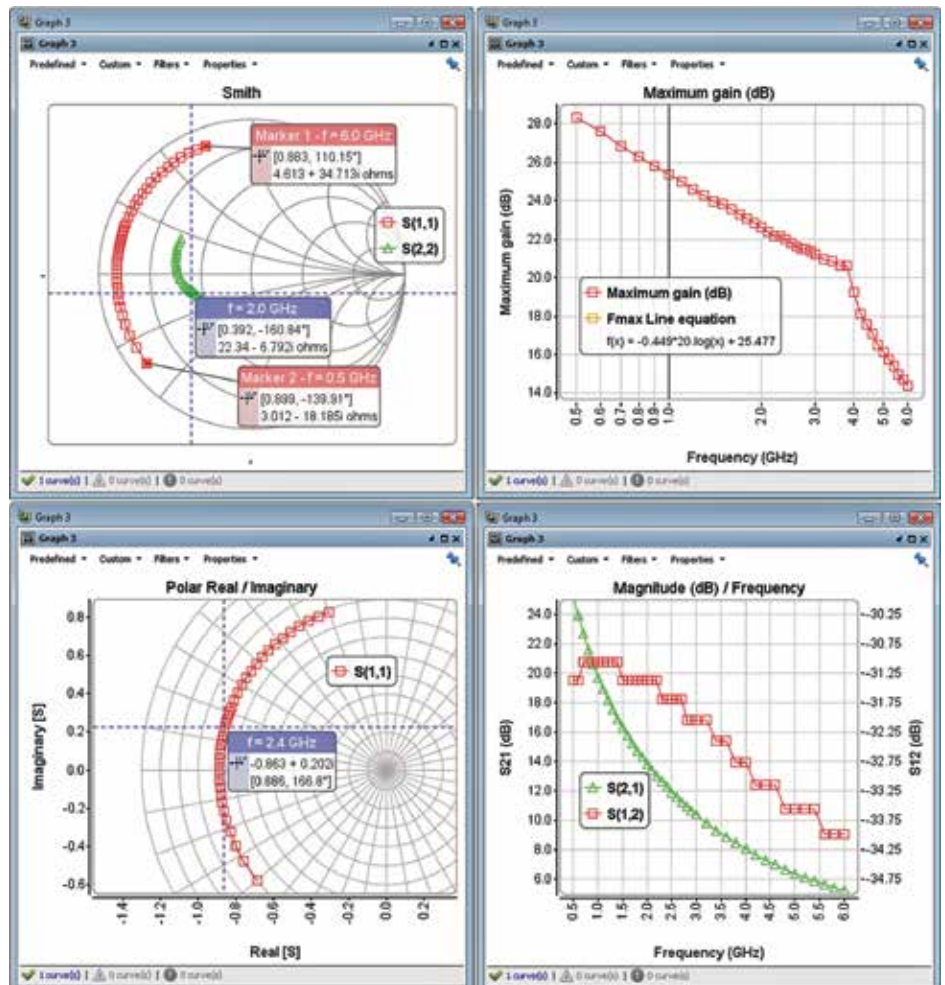

S-Parameters Plotted on Smith Chart, Maximum Gain, Polar, and Magnitude

MT930GA IVCAD Time-Domain LSA Add-On

MT930GA is an add-on module for MT930C Vector-Receiver Load Pull which enables time-domain large signal analysis and waveform reconstruction when used with supported VNAs and comb generators (harmonic phase references), and does not require third-party nonlinear VNA software. The LSA add-on records the phase dependency of harmonic content and allows a- and b-waves, voltage and current waveforms, and load lines to be displayed for each measurement state (impedance/power/bias) and can be de-embedded to the device reference plane.

Time-domain analysis, or Waveform Engineering, allows the analysis of currents and voltages at the device input and output terminals in order to identify the DUT's mode of operation. This tool is useful in the study and design of advanced amplifier classes of operation including E, F, J and K and their inverses.

When used in combination with MT930R1 IVCAD EPHD Behavioral Model Extraction, an enhanced Poly-Harmonic Distortion behavioral model can be extracted for each measurement state with no significant addition of time.

MT930GB IVCAD Keysight NVNA Support Add-On

MT930GB is an add-on module for MT930C Vector-Receiver Load Pull which enables time-domain large signal analysis and waveform reconstruction in conjunction with Keysight PNA-X network analyzer with NVNA software option enabled.

MT930GB relies on the NVNA application to measure the phase dependency of harmonic content and allows a- and b-waves, voltage and current waveforms, and load lines to be displayed for each measurement state (impedance/power/bias) and can be de-embedded to the device reference plane.

With the appropriate PNA-X options, MT930GB also enables the extraction of X-parameters behavioral models.

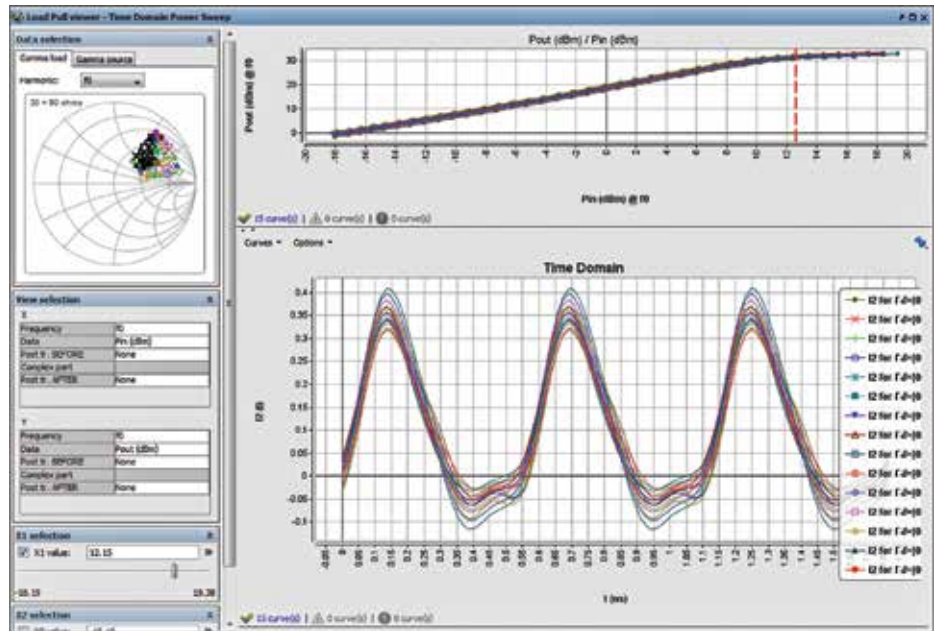

Output Current Waveforms at Constant Input Power Under Varying Load Impedances

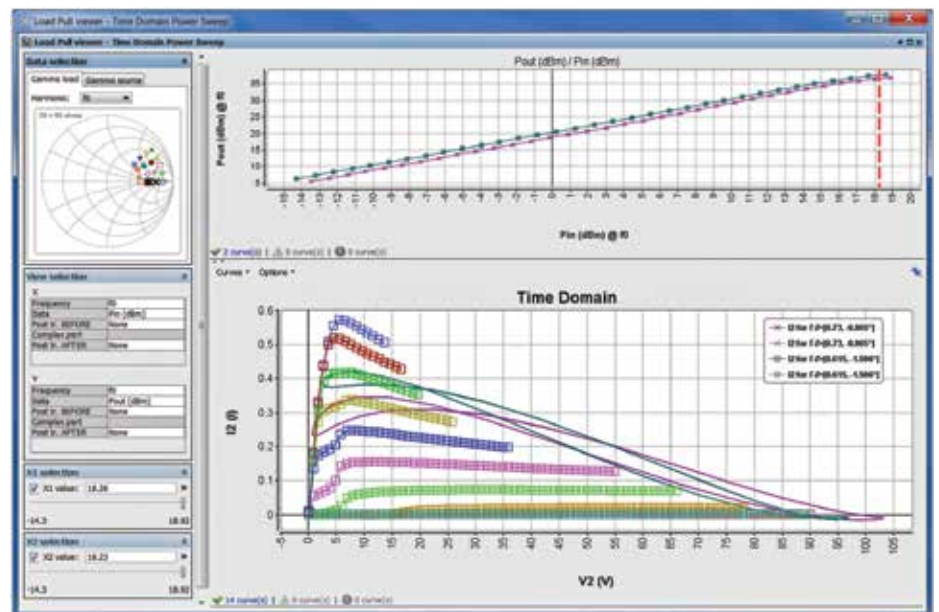

DC and RF Load Lines at Constant Input Power Under Varying Load Impedances



MT930H IVCAD Active Load Pull

MT930H is an add-on module for MT930C Vector -Receiver Load Pull which enables active load pull in conjunction with internal and external sources for fundamental and harmonic load pull measurements. Considering our DUT as a two-port device shown below, Γ_L is nothing more than a_2/b_2 , or the ratio between the reflected- and forward-traveling waves. A generalized form of the formula can be written as

$$\Gamma_{x,n}(f_n) = \frac{a_{x,n}(f_n)}{b_{x,n}(f_n)}$$

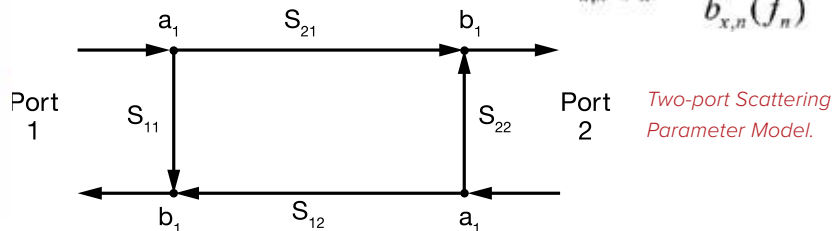

Key Features

- > Enhanced active load pull algorithm for faster and safer convergence

A closer examination of the formula $\Gamma_L = a_2/b_2$ reveals that there is no limitation on separating the sources of a_2 and b_2 . It is obvious that b_2 is the wave coming from the device, of which we have no direct control; however a_2 need not be a reflected version of b_2 but can be a new signal entirely!

Active Load Pull – Active injection load pull, more commonly referred to as active load pull, relies on external sources to inject a signal into the output of the DUT, thereby creating a_2 . Because a_2 is no longer limited to a fraction of the original reflected signal, as is the case with the traditional passive mechanical tuner, external amplifiers may be used to increase a_2 nearly indefinitely so that Γ_L can achieve unity. The simple active tuning chain consists of a signal source, a variable phase shifter and a variable gain stage, shown in the diagram below. Common signal generators that have built-in amplitude and phase control of the injected signal are ideal for active load pull.

Harmonic load pull, or tuning impedances at multiple frequencies simultaneously, becomes simple when using active load pull techniques. A multiplexer can be used to merge multiple active tuning paths, one per frequency,

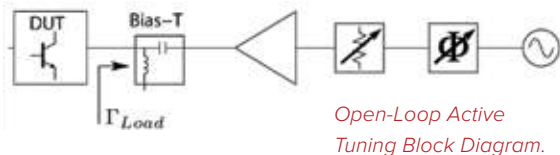

so that $\Gamma_{x,n}(f_n) = \frac{a_{x,n}(f_n)}{b_{x,n}(f_n)}$ is satisfied.

Any losses inherent to multiplexers are easily overcome by the amplifiers used in each active tuning chain.

Hybrid-Active Load Pull – Both traditional passive mechanical tuner systems and active injection load pull systems have their advantages and disadvantages. While mechanical tuners are simple, less expensive and can handle high power, there is no physical way to overcome the losses involved with the system that limit achievable Γ_L . While active load pull systems are extremely quick, capable of $\Gamma_L=1$ and easily integrated for harmonic measurements on-wafer, high-power setups require more-expensive band-limited amplifiers.

It is possible to obtain the advantages of both systems while minimizing the disadvantages, using a technique referred to as hybrid load pull. Hybrid load pull refers to a combination of active and passive tuning in the same system. Traditional passive mechanical tuners can be used to reflect high power at the fundamental frequency allowing a much smaller active injection signal, using much smaller amplifiers, to overcome losses and achieve $\Gamma_L=1$. Additionally, since the powers at harmonic frequencies are often well below the power of the fundamental signal, less-expensive wideband amplifiers may be used with active tuning to accomplish active harmonic load pull with $\Gamma_{L,n}=1$. In both cases, only a low power is required for active tuning.

**MT930H IVCAD Active Load Pull
(continued)**

Hybrid-Active Load Pull at 30–50 GHz



Output Power and PAE Contours at High-Gamma Enabled by Hybrid-Active Load Pull

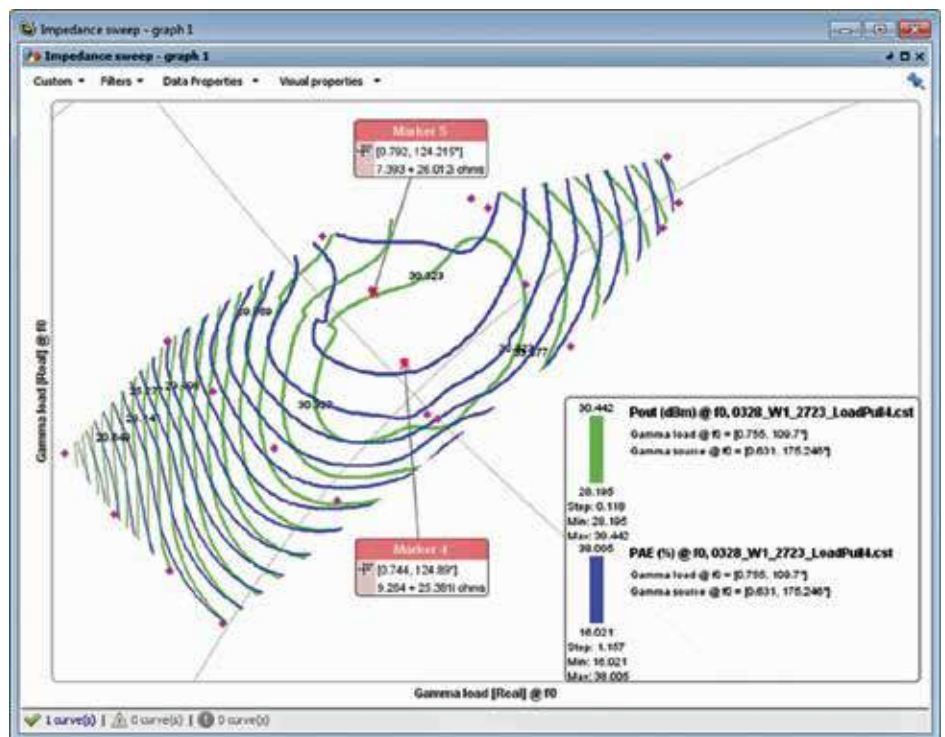

MT930J IVCAD Pulsed IV Curves

MT930J is a stand-alone module for advanced Pulsed IV measurements using dedicated pulsing hardware (e.g., AMCAD's BILT Pulsed IV system).

Current-voltage (IV) measurements are used to describe the relationship between the input and output currents and voltages of a device. Standard GaN Field Effect Transistors (FETs) are characterized by measuring the output current as a function of output voltage for swept input voltages. Because GaN devices tend to self-heat and are susceptible to trapping effects, it is important to pulse voltages between a quiescent and hot value and define appropriate pulse-widths. By pulsing the voltage, a lower average power will be delivered to the device thereby reducing self-heating. Such a measurement allows for near-isothermal performance.

IVCAD enables the visualization of trapping phenomena, gate lag and drain lag, on GaN transistors. It is a simple task to view trapping effects as a function of varying quiescent bias.

IVCAD has implemented full wafer control by interfacing with Cascade Nucleus software.

Key Features:

- > Pulsed configuration and calibration of all instruments (including PIV system and VNA) controlled by IVCAD
- > Graphical pulsed chronogram easily defines gate, drain, RF source and measurement windows
- > Sweep input or output voltages in linear, adaptive and custom voltage steps
- > IV trace screenshot visualizes IV waveform without the need for an oscilloscope
- > VNA operated in NBW for enhanced accuracy S-parameters
- > Multiple stop conditions for voltages, currents, powers and temperatures
- > Automated probe station control
- > Export data to ICCAP, ADS and Microwave Office

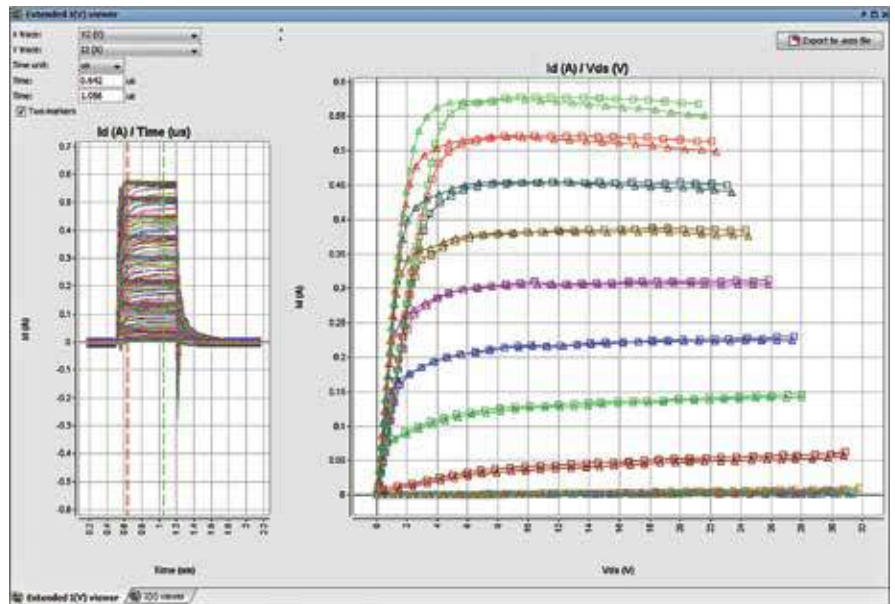

Pulsed IV Curves Plotted at Different Times with Pulse

MT930K IVCAD Pulsed S-Parameters

MT930K is an add-on module to MT930J which enables synchronized Pulsed S-Parameter measurement in conjunction with Pulsed IV.

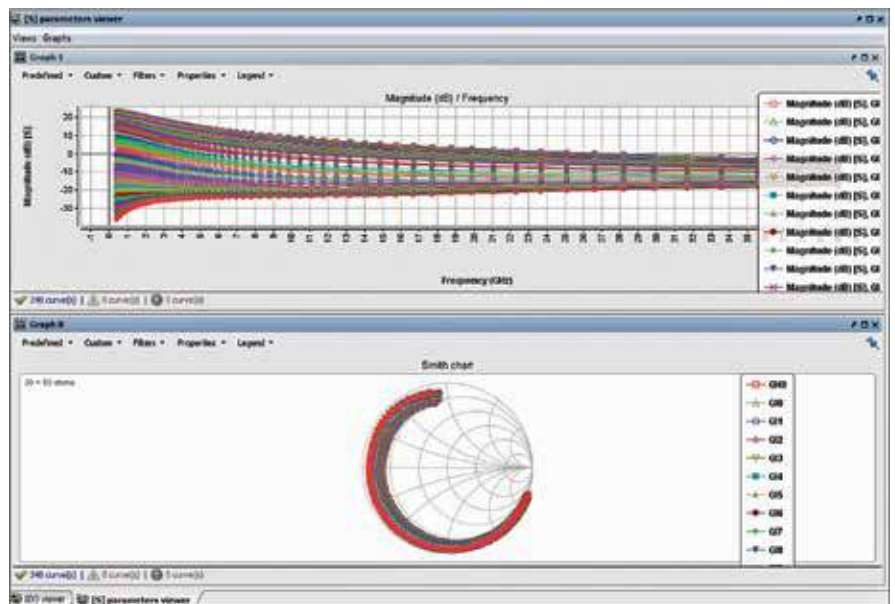

Pulsed S-Parameters Under Varying Bias Conditions

MT930L IVCAD Scripting Language

MT930L is an add-on module to MT930C/D/J/K which enables complex test sequencing through a dedicated scripting language.

Scripting is available both internally to IVCAD and as an external script server. The script server allows users to run IVCAD as slave software, controlled by an external application, through TCP/IP sockets.

TCP/IP sockets allow programs to talk through a network, but a communication between two programs on the same computer can also be established.

Internal scripting is managed by the script editor, which includes functions divided into several categories:

Concurrency – functions related to threading

User interfaces – functions related to creating windows, docking windows, fonts, labels, 2D and 3D graphs, wafer maps

I/O – functions related to logging events, printing messages, reading and writing characters, managing files and directories

Math – functions related to math, values, vectors, arrays, rows, factorial operations, complex numbers, conversions, exponents, interpolation, trigonometry

Measurements – functions related to impedance control, IV control, probe station control, tuner control, setup management

Scripting – functions related to loops, conditions, if/else

SQL – functions related to database management

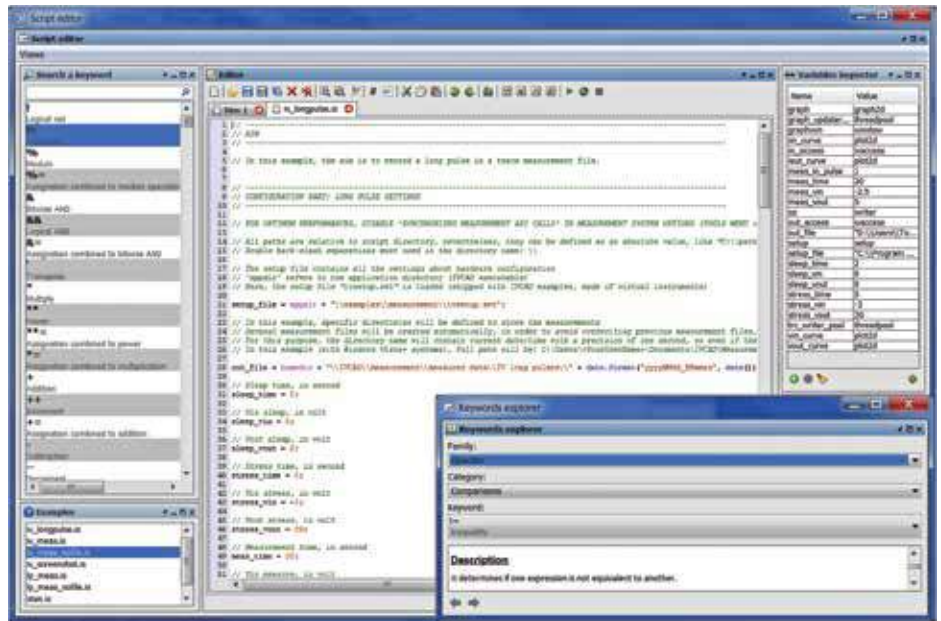

Script File Tuning Source and Load Within IVCAD



Script Server

MT930M1 IVCAD Linear Model Extraction

MT930M1 is an add-on module to MT930J and MT930K for Linear Model Extraction.

Linear Model Extraction is used to determine the extrinsic parameters (parasitic elements) and intrinsic parameters of III-V and LDMOS transistors. Linear modeling fits measured data to linear model equations, and can be automatically optimized or manually tuned to solve for values of the extrinsic (R_g , L_g , C_{pg} , R_d , L_d , C_{pd} , R_s , L_s) and intrinsic parameters.

Linear model extraction is a critical first step in the transistor modeling process, and any errors resulting from linear model inaccuracies will prevent the extraction of nonlinear models. A wizard guides users through a step-by-step process in order to eliminate user errors and ensure first-pass linear model extraction success. Validation is provided by comparing intrinsic elements through a multi-bias extraction. Netlist export is available at each level of the linear model extraction process.

The resulting linear model can be used with MT930M2A and MT930M2B to generate nonlinear models, or exported to commercial circuit simulators. The linear model can also be used to de-embed time-domain load pull data to the intrinsic device reference plane, and visualize intrinsic load lines for advanced amplifier classes.



Linear Model Comparing Measured And Optimized Data

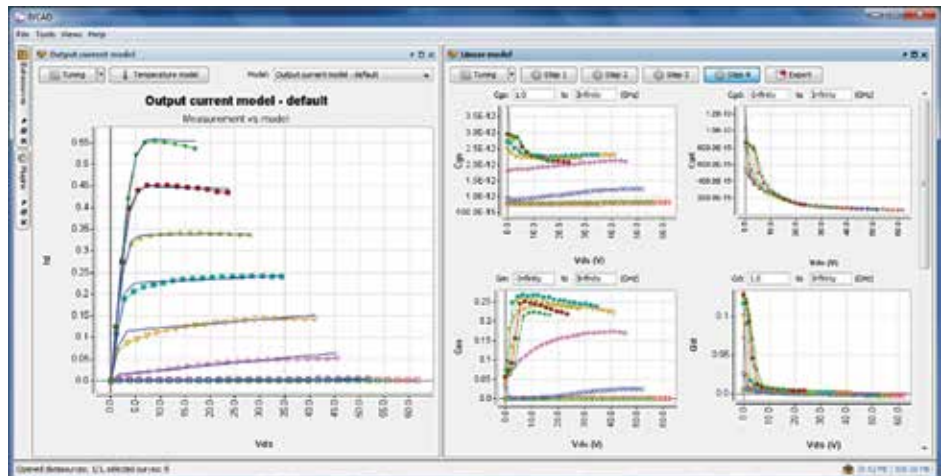

Multi-Bias Capacitances and Transconductance Model Extraction

MT930M2A IVCAD Nonlinear Model Extraction, III-V

MT930M2A is an add-on module to MT930M1 for Nonlinear Model Extraction of III-V device technologies. The extrinsic parameters measured through linear modeling (MT930M1) are used to extract intrinsic parameters.

In quasi-isothermal conditions, MT930M2 uses synchronized pulsed IV/RF measurements to extract the parameters of the AMCAD nonlinear equations that describe the nonlinear capacitances, diodes, and current sources of the transistor. Pulse widths are kept sufficiently short in order to avoid a strong temperature variation during the pulse duration and the duty cycle is kept sufficiently low in order to avoid a mean variation of the temperature, so that the transistor's pulsed IV measurements are obtained under quasi-isothermal operating conditions. S-parameters are measured in the steady-state region of the signal.

Nonlinear Capacitance Model Extraction – For III-V or LDMOS transistors, thanks to a selection of the IV plots close to the expected RF load line, the capacitance values will be extracted according to the instantaneous V_{gs} and V_{ds} values. In

order to extract an accurate and robust model regarding the convergence of the simulation, the nonlinear models will be provided under the form of a “one dimension” formulation. Thus C_{gd} will be a function of intrinsic V_{gd} while C_{gs} will be a function of the intrinsic V_{gs} voltage. The comprehensive parameters of these equations can be tuned manually or optimized automatically. For III-V transistors C_{ds} is provided as a linear model; for LDMOS transistors C_{ds} is provided as a nonlinear capacitance model.

Diode Parameter Extraction – For III-V transistors, the gate current will be accurately modeled by two diodes (D_{gs} and D_{gd}), biased in forward mode.

The manual or automatic tuning of the diode's parameters provides an accurate fit of the positive gate current at low V_{ds} and high V_{gs} voltages. The negative gate current for high V_{ds} voltages in pinch-off conditions is provided by a breakdown generator.

Output Current Extraction – A specific algorithm is used to extract the output current source model, which provides a reliable description of the I_{ds} current for different V_{ds} and V_{gs} voltages.

The formulation used enables an accurate description of the output current sources and its derivatives (gm, gd). The comprehensive parameters of these equations can be tuned manually or optimized automatically.

MT930M2A uses a modified Tajima current source model for III-V transistors.

IVCAD employs a comprehensive library and flexible formula editor which allows users to create custom model parameters and parameter extraction equations. Users can implement proprietary equations based on their own experiences and expertise, and benefit from IVCAD's optimization algorithms and GUIs.

MT930M2B IVCAD Nonlinear Model Extraction, LDMOS

MT930M2B is an add-on module to MT930M1 for Nonlinear Model Extraction of LDMOS transistors. The extrinsic parameters measured through linear modeling (MT930M1) are used to extract intrinsic parameters.

MT930M2B uses a proprietary AMCAD current source model for LDMOS transistors.

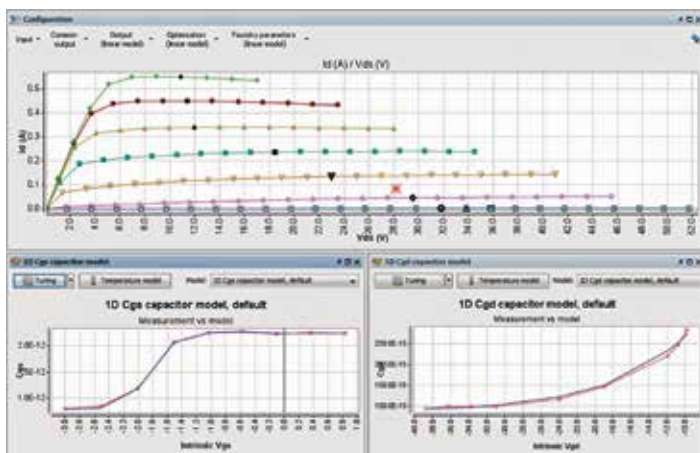

Capacitance Model Extraction Showing Excellent Match Between Measurement and Modeled Data

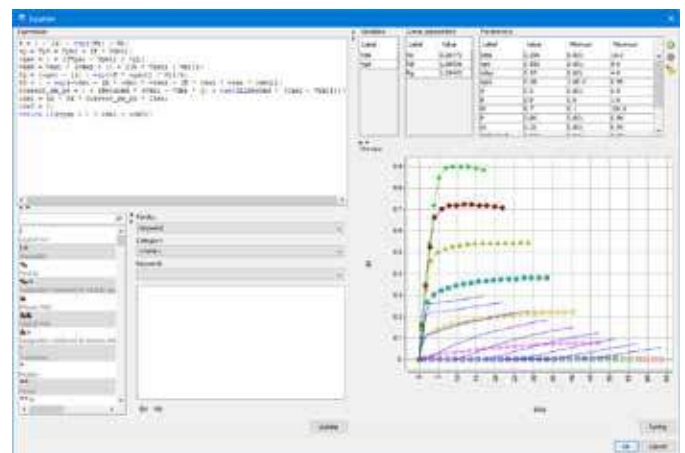

Equation Editor for Nonlinear Model Extraction

Current Source Extraction
 Showing Excellent Match
 Between Measured And
 Modeled Data

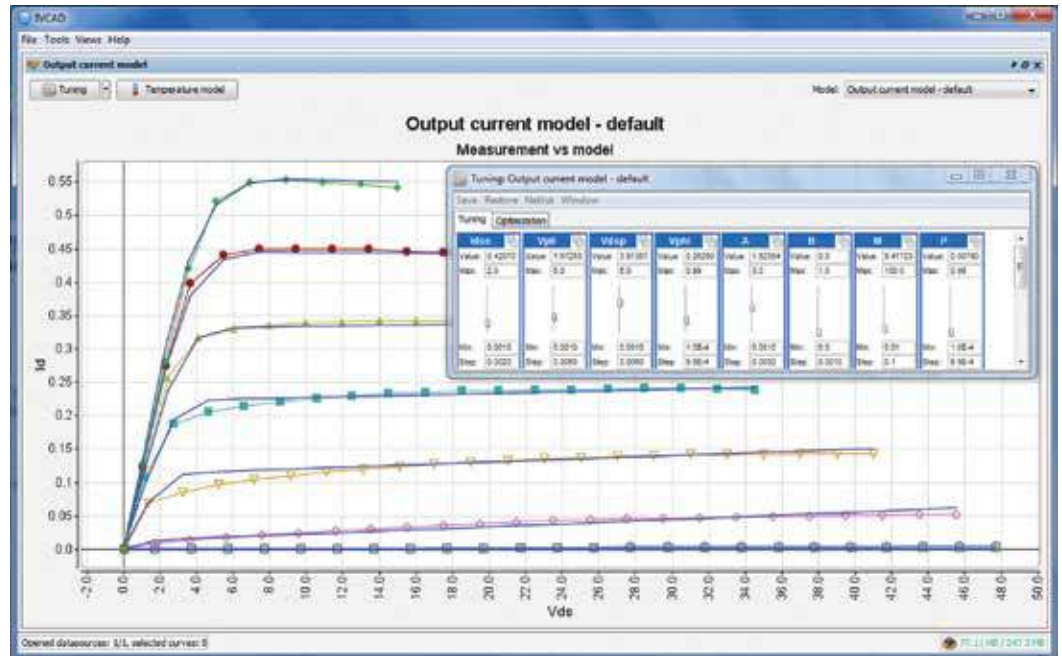

AMCAD III-V Model Template

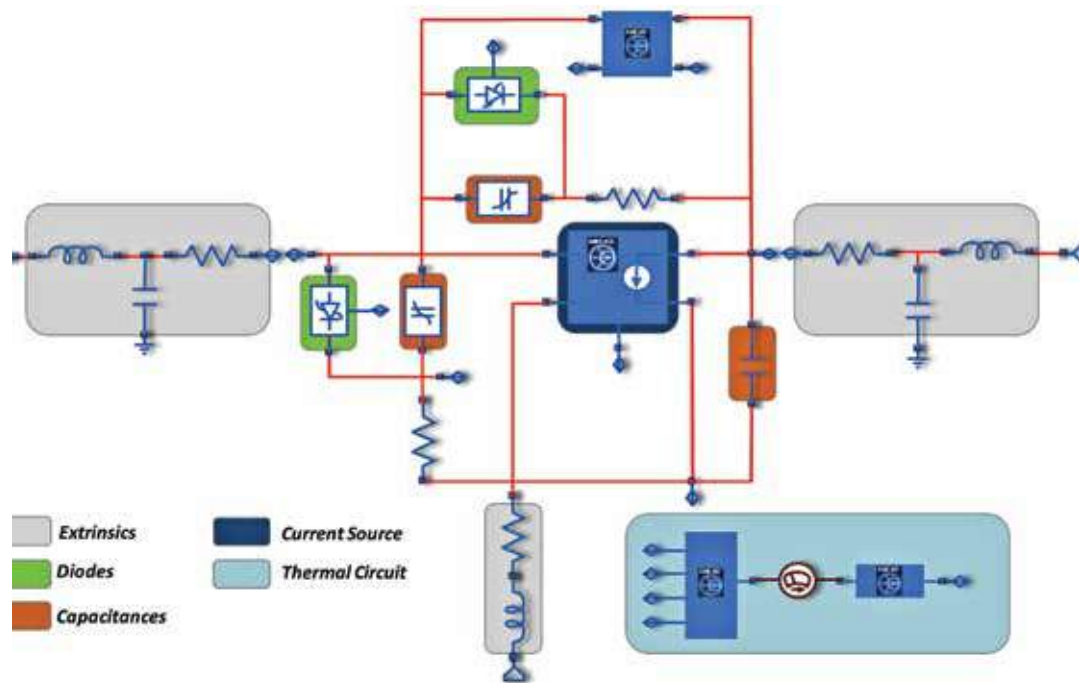

MT930P Toolbox

MT930P is a stand-alone module which enables useful mathematical tools post-measurement.

- > IV Tools – compute gm/gd, convert IV data sets, interpolate/extrapolate IV points.
- > S-parameters – TRL fixture extraction, interpolate/extrapolate S-parameters.
- > De-embedding – de-embedding S-parameters, intrinsic de-embedding of S-parameters based on linear model.
- > Converter – mathematical calculator for converting phase, power, VSWR, impedance.

MT930Q IVCAD Stability Analysis Tool

Stability Analysis Tool (STAN) is a revolutionary stability analysis technique for microwave circuits, which is valid for both small-signal and large-signal regimes. This tool is able to detect and determine the nature of oscillations, such as parametric oscillations in power amplifiers, that may be functions of the input drive signal. Knowledge of the type of oscillation mode facilitates the insertion of stabilization networks, with a better balance between the required oscillation avoidance and maintaining the original circuit performances.

The STAN approach calculates a single-input, single-output (SISO) transfer function for a circuit of interest linearized around a given steady state. A simulated frequency response of the linearized circuit is fitted to a rational polynomial transfer function by means of frequency-domain identification algorithm. If no poles on the right-half plane (RHP) are found, it is considered stable.

Key Features:

- > Single-node analysis
- > Multi-node analysis
- > Parametric analysis under varying load impedances
- > Parametric analysis under varying input signal power
- > Monte Carlo analysis
- > Compatible with IC, MMIC and hybrid-amplifier designs
- > Templates supplied

STAN is compatible with major commercial circuit simulator tools.

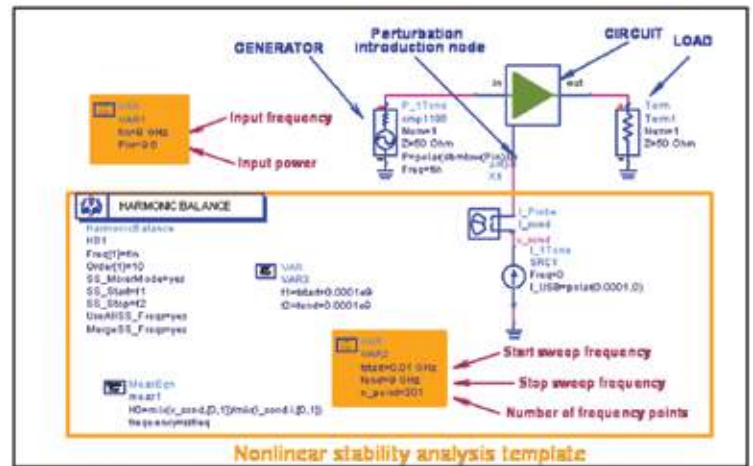

Nonlinear Stability Analysis Template

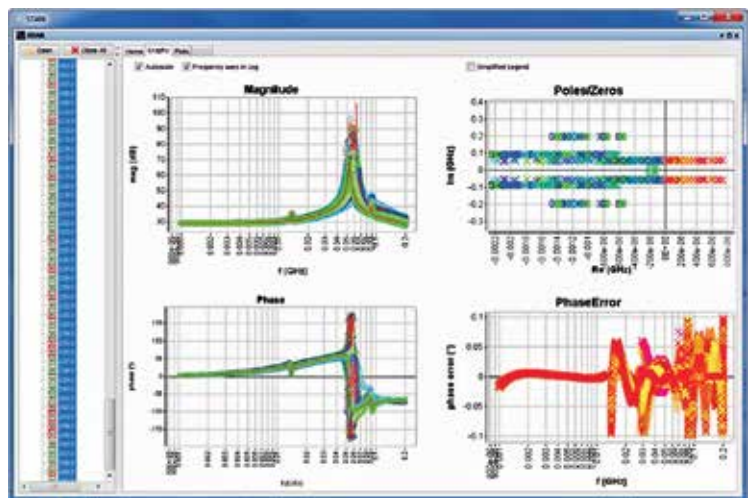

STAN Tool Graphical User Interface

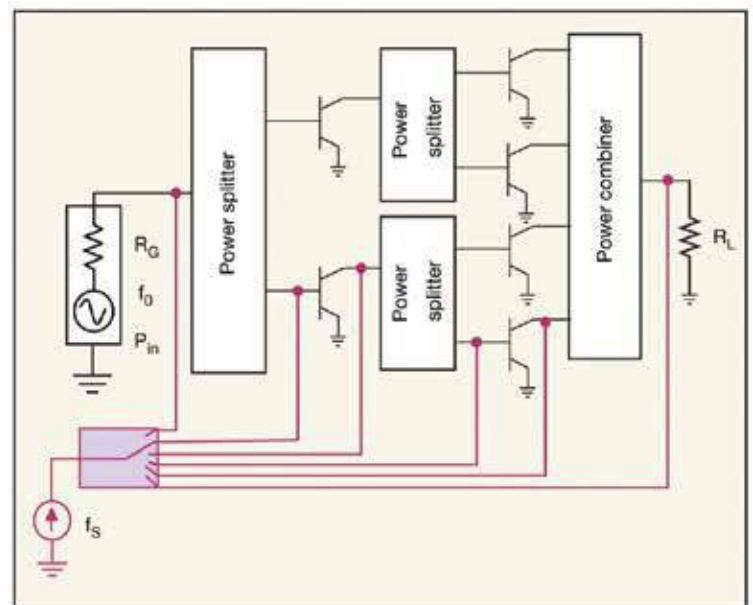

Diagram Showing a Multinode Stability Analysis of an RF/microwave Amplifier

MT930R1 IVCAD EPHD Behavioral Model Extraction

MT930R1 is a stand-alone module for Enhanced PHD (EPHD) behavioral model extraction directly from Vector-Receiver Load Pull measurement data.

The EPHD Model is based on Poly-Harmonic Distortion theory with a dynamic power expansion order. The methodology has been designed for simulation requirements where loading conditions are significantly different than those used during the measurement, and accurate interpolation and/or extrapolation is required.

Based on successful industry implementation, the EPHD behavioral model has been proven to show excellent robustness and convergence even when a DUT sees a dynamic load impedance modulation, which is typical in the case of highly nonlinear classes of operation (i.e. Class C).

MT930R1 is especially useful for the behavioral model extraction of packaged transistors to be used in the design of power amplifier circuits.

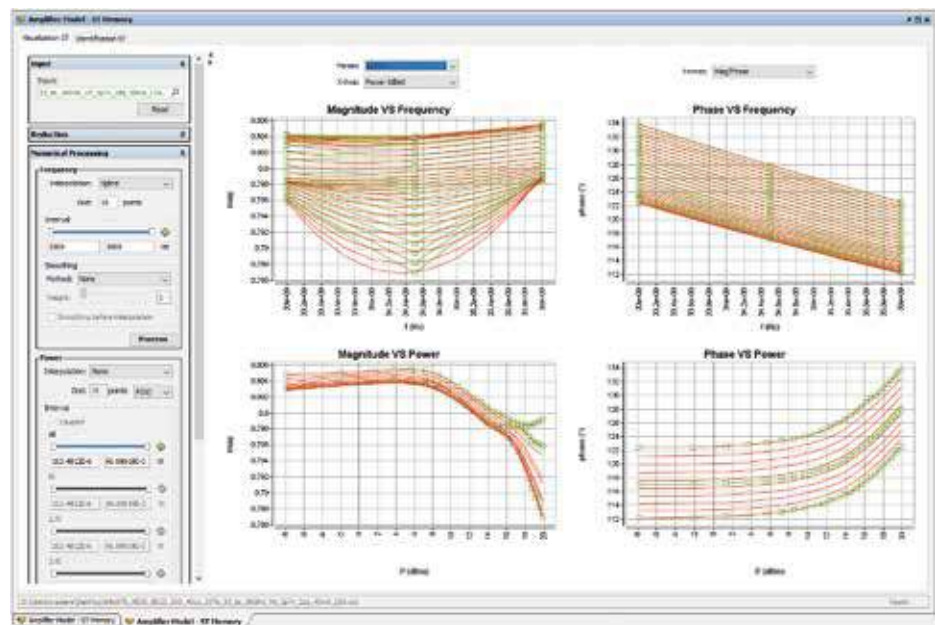

Visualization of Behavioral Model Terms

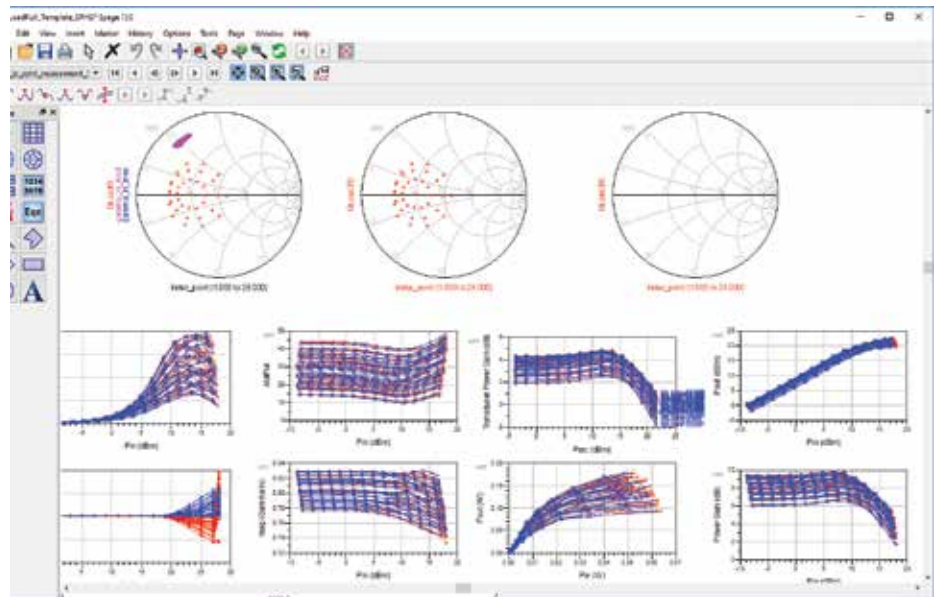

ADS Comparison of Measured and Modeled Performance Parameters

Vertigo MT920-Series MMW-STUDIO

MILLIMETER-WAVE AND SUB-
THZ CHARACTERIZATION
SOFTWARE

Powered by

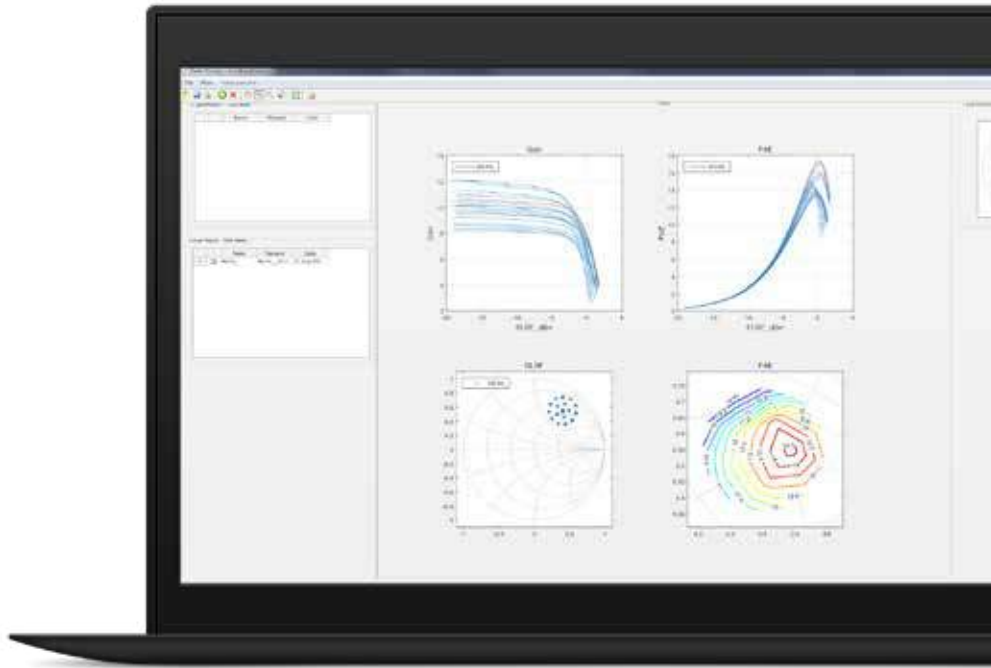

Introduction

MT920A MMW-STUDIO is a software suite designed to work with waveguide-banded millimeter-wave VNA systems and add accurate and repeatable high-resolution power control. The software enables the direct measurement of vector corrected power at the DUT reference plane, as well as control over the power delivered to the DUT. Doing so allows engineers to perform gain compression power sweep measurements over the available levels of power, and to perform S-parameter measurements at any arbitrary power level.

MMW-Studio Models:

MT920A — MMW-STUDIO, mmW Studio High resolution power control for S-parameters and gain compression power sweep measurements

MT920B — MMW-STUDIO, mmW Studio Active load pull at millimeter-wave and sub-THz frequencies add-on

MT920C — MMW-STUDIO, mmW Studio Data display



DATA SHEET
4T-024

MMW-STUDIO enables:

- > S-parameters measurements at user-specified power levels
- > Fundamental powers (P_{in} , P_{av} , P_{load}), gain and efficiency measurements at 50Ω
- > High-resolution power control for accurate and repeatable vector-corrected 50Ω gain compression power sweep measurements
- > Calibrated measurements at DUT reference plane
- > Support for most commercial waveguide extenders up to 1.1 THz
- > Power, frequency and bias sweep

MT920B MMW-STUDIO LP is a software add-on, which when used in conjunction with a Vector Modulation Unit (VMU), enables control over the magnitude and phase of the signals delivered to the input and output of the DUT. This enables an engineer to set arbitrary impedances, or perform active load pull measurements, where the magnitude of reflection presented to the DUT is achieved by controlling the reflected a_2 wave and fulfilling $\Gamma = a_2/b_2$.

MMW-STUDIO LP adds:

- > Arbitrary impedance control / active load pull
- > Measurements of fundamental powers (P_{in} , P_{av} , P_{load}) at arbitrary impedance

The system takes advantage of the frequency multiplication provided by millimeter wave extenders to extend active impedance tuning up to 1.1 THz.

MMW-STUDIO and MMW-STUDIO LP empower conventional waveguide banded millimeter-wave VNA systems to perform power measurements, large signal testing and active load-pull without using power meters¹, passive impedance tuners or additional test-sets, thereby taking advantage of the large dynamic range and high speeds of the VNA's receivers while maintaining a seamless setup configuration and user experience. These capabilities are critical for:

- > Small/large signal model extraction of high frequency transistors up to f_T/f_{max}
- > Small/large signal model validation of high frequency transistors up to f_T/f_{max}
- > Prototype testing and optimization of (sub)THz active circuits
- > Research and development, design validation test, and on-wafer production test

¹A waveguide-flanged power meter is needed during calibration but is not employed for direct power measurement of the DUT.

Power control at millimeter-wave and sub-THz frequencies

Typical millimeter-wave S-parameter measurement systems use banded waveguide extenders to measure at the frequencies of interest, each having a fixed output power determined by the response of the up-conversion chain. Because of the nonlinearity of this response across frequency, the power at the output of the extender will vary as a function of frequency, with a flatness as high as 10 dB over the entire band. Some vendors will offer optional manual attenuators, but these are cumbersome to use and do not offer the high dynamic range required to fully characterize a DUT. In addition, the conventional power-control loop of the VNA is excluded from the measurement path which makes controlling the power complicated.

MMW-STUDIO employs a proprietary calibration procedure and algorithm to control the power delivered to the DUT at every frequency supported by the banded waveguide extender. The system block diagram, typical power flatness of a banded waveguide extender, and power control using MMW-STUDIO are shown in Figure 1.

The procedure is comprised of four steps, and is outlined in Figure 2:

1. S-parameter calibration at waveguide test-port. VNA S-parameter calibration using TRL or LRM methods
2. Power calibration

Using a waveguide-flanged power meter connected to one of the mm-wave extenders, the absolute power is measured across frequency and associated with the measurement of waves using the VNA's receivers. This procedure empowers the system to directly measure power using the VNA instead of a power meter.

3. Power levelling

The nonlinear power responses of the millimeter-wave extenders are characterized by sweeping the frequency at different input power levels (the control dynamic range) in order to cover the entire extender dynamic range (the detection dynamic range). This results in the creation of a look-up-table (LUT) which associates the power set by the VNA to the power available at the waveguide test-port at each frequency. This LUT is used to set any arbitrary power at the test-port, within the extender module's dynamic range.

4. Probe-tips/on-wafer calibration

The effect of wafer probes can be characterized using MMW-STUDIO's calibration GUI, or by using external software (such as WinCal XE). The measurement reference plane is then transferred from the waveguide extender to the probe-tip.

After the system is calibrated, MMW-STUDIO allows, in the entire frequency range of the employed waveguide-banded mm-wave extenders:

- > S-parameters measurements with arbitrary power control at each frequency, defined at the DUT reference plane.
- > Gain compression power sweep measurements over large dynamic ranges at the DUT reference plane.
- > Measurements of fundamental powers (P_{in} , P_{av} , P_{load}), gain and efficiency at 50Ω

Figure 1:

a) Simplified schematic of a conventional mm-wave VNA setup based on waveguide banded module. When coupled with an external controlling computer and a power meter, MMW-STUDIO can be used to allow power control

b) Power available at the waveguide port of a commercially available WR5 VNA extender, without power control (asterisks) and with fixed -30 dBm power control using MMW-STUDIO (filled square)

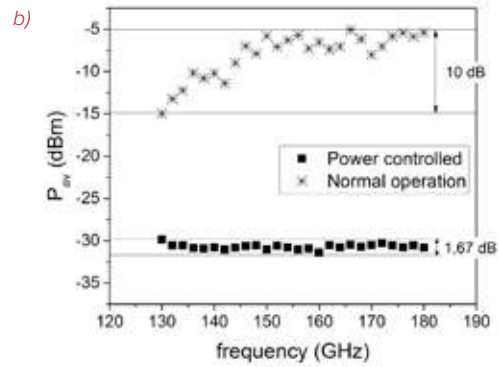
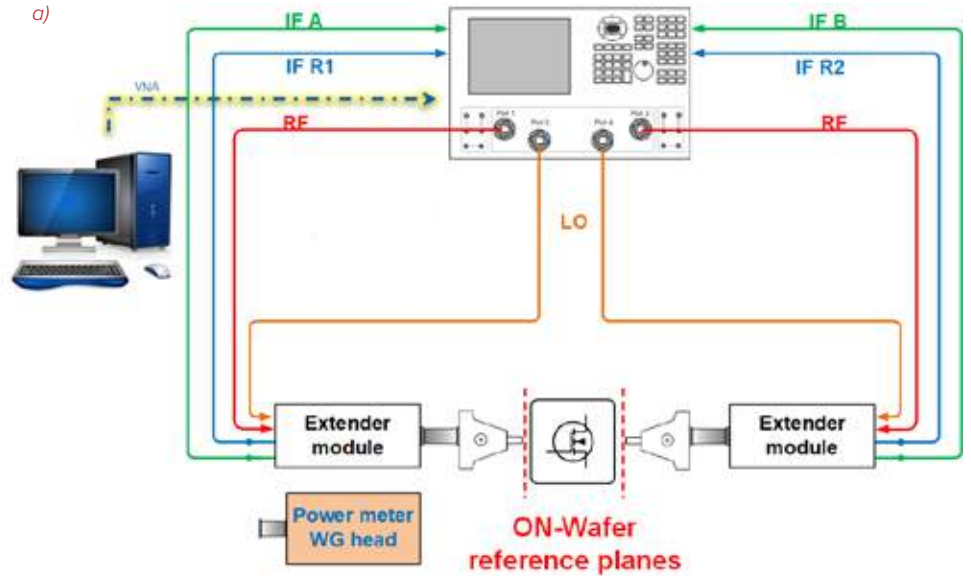
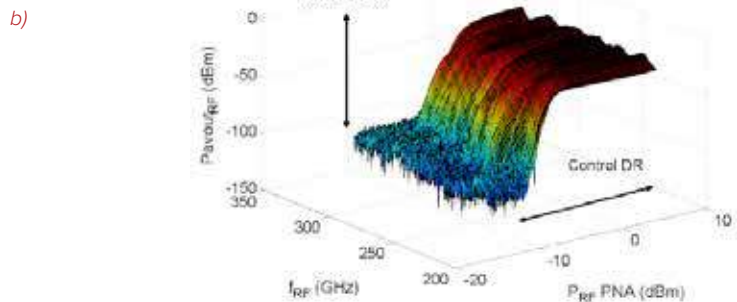
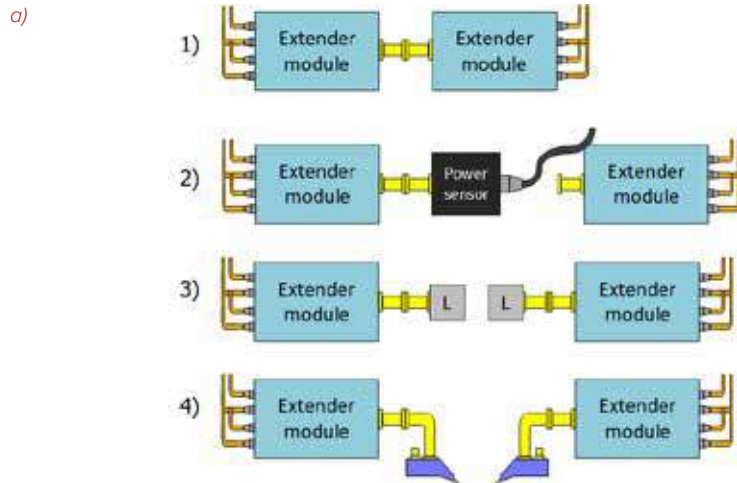

Figure 2:

a) Calibration steps for MMW-STUDIO

b) LUT resulting of a power levelling using commercially available WR3 extender modules



Load pull at millimeter-wave and sub-THz frequencies

An introduction to load pull

Load Pull is the act of presenting a set of controlled impedances to a device under test (DUT) and measuring a set of parameters at each point. By varying the impedance, it is possible to fully characterize the performance of a DUT and use the data to:

- > Verify simulation results of a transistor model (model validation).
- > Gather characterization data for model extraction (behavioral model extraction).
- > Design amplifier matching networks for optimum performance (amplifier design).
- > Ensure a microwave circuit's ability to perform after being exposed to high mismatch conditions (ruggedness test).
- > Confirm the stability or performance of a microwave circuit or consumer product under non-ideal VSWR conditions (stability/performance/conformance/antenna test).

Figure 3a—Example of load pull measurements with Output Power (Pout) contours plotted on a Smith Chart.

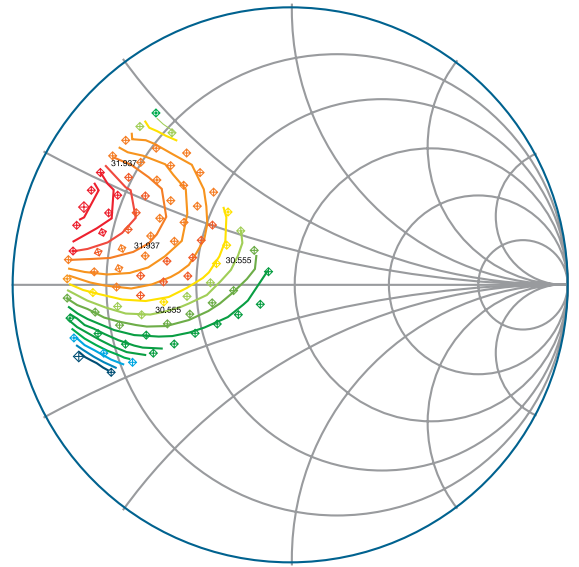

Figure 3b—Iso Pout Contours Measured @ 1.85 GHz

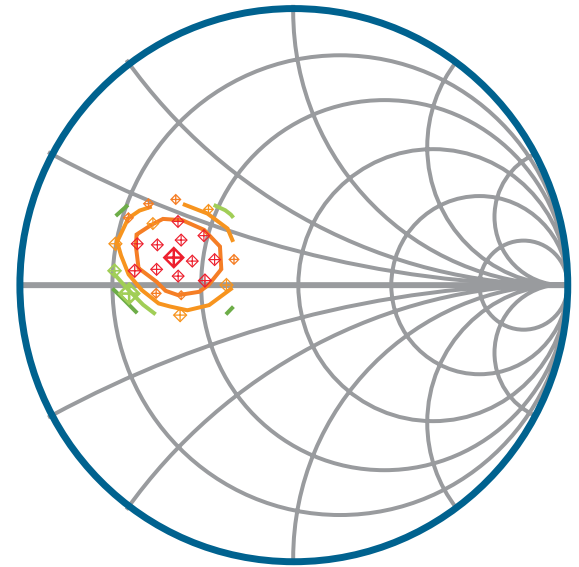
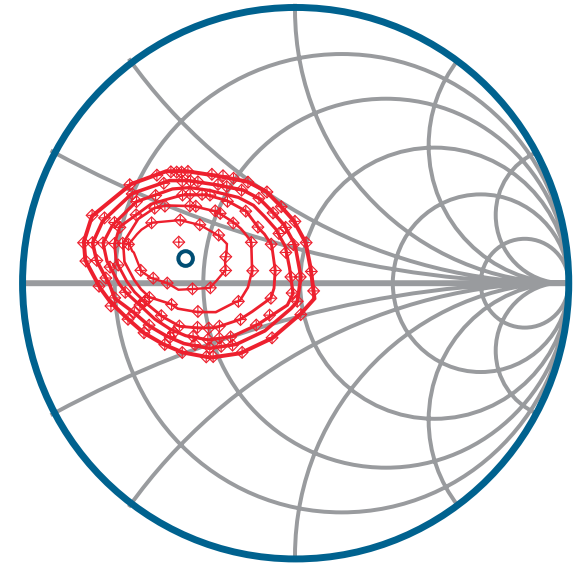

Figure 3c—Iso Pout Contours Simulated @ 1.85 GHz



Active load pull

In order to understand how the impedance presented to a DUT is varied, we must first consider the DUT as a two-port network shown in Figure 4.

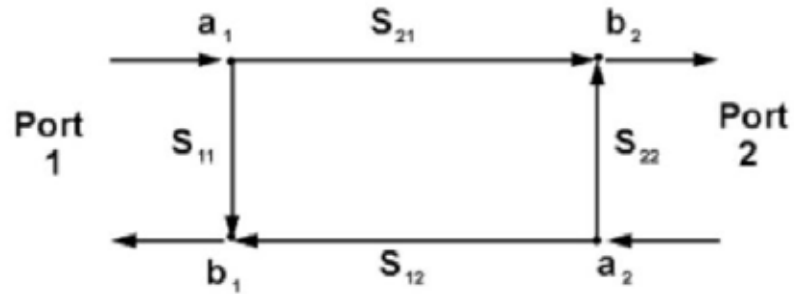

Figure 4: Two-port representation of a DUT

The two-port network consists of four waves, a_1 , b_1 , b_2 and a_2 .

- > a_1 is the input signal which is injected into port 1 of the DUT
- > b_1 is the input signal which is reflected from the input of the DUT due to the mismatch between the DUT's input impedance and the load impedance of the input network
- > b_2 is the signal which emerges from port 2 of the DUT
- > a_2 is the output signal which is reflected from the output of the DUT due to the mismatch between the DUT's output impedance and the load impedance of the output network

The magnitude of reflection presented to the DUT is calculated as $\Gamma_L = \frac{a_2}{b_2}$. The magnitude and phase of the reflection presented to the load of the DUT can be varied by changing the magnitude and phase of the signal a_2 . In other words, any load impedance $Z_L = \frac{Z_0(1-\Gamma_L)}{1+\Gamma_L}$ can be presented to the DUT as long as the signal a_2 can be achieved.

With regards to active load pull, the signal a_2 is a vector combination of the reflected portion of b_2 due to the mismatch between the DUT's output impedance and the load impedance of the output network, and a new signal created by a signal generator with magnitude and phase variability (referred to as an active tuning loop). An example block diagram of an active tuning loop is shown in Figure 5.

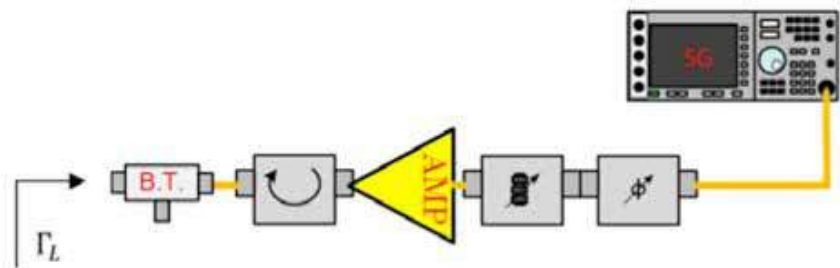

Figure 5: Output network of a simple active load-pull setup

In order to perform active load pull, it is necessary to have a vector-receiver capable of accurately measuring the a- and b-waves, as well as signal generator(s) capable of generating output tuning signals.

Millimeter-wave and sub-THz active load pull

The challenge with active load pull at millimeter-wave and sub-THz frequencies using waveguide extenders is solving how to adjust the magnitude and phase of the a_2 signal in order to obtain the desired Γ_L . MMW-STUDIO LP's methodology is to manipulate the magnitude and phase of the low-frequency signal going into the waveguide extender before the frequency multiplication occurs. This results in a change of the high-frequency signal's magnitude and phase, and when fully characterized, can be used to set an arbitrary a_2 wave and hence perform active load pull. The low-frequency signal is generated using the internal, low-phase-noise, synthesizer of the VNA. The magnitude and phase of the signal is manipulated using a vector modulator unit (VMU), which allows an arbitrary impedance to be set. Like lower frequency active load pull, the high dynamic-range receivers of the VNA are used to measure the a_1 , b_1 , a_2 and b_2 waves.

A simplified system block diagram of a millimeter-wave and sub-THz load pull system is shown in Figure 6. Compared with the typical 50Ω system shown in Figure 1, the main differences are as follows:

1. The RF signal for both P1 and P2 is obtained from a single shared VNA source
2. VMUs are placed between the VNA and the millimeter-wave extender modules
3. Control signals (CS1 and CS2) are used to tune the output signal of the VMU and are generated using an external digital-to-analog converter (DAC)

During active load pull, a single-tone signal is generated by the internal synthesizer of the VNA, at a frequency $f_{vna} = \frac{f_{meas}}{N}$,

where f_{meas} is the intended millimeter-wave measurement frequency, and N is the multiplication factor of the millimeter-wave extender module. Using CS1 (and the VMU) the power available at P1 is controlled and provided to the DUT. The response, b_2 , of the DUT is measured at frequency f_{meas} using the receiver path of the extender module at P2 and the VNA receivers. The a_2 wave needed to synthesize a desired Γ_L is computed, and achieved using CS2, the VMU and iterative measurements. Finally, the a- and b-waves are measured at the DUT reference plane and used to compute all the quantities of interest (reflection coefficients, fundamental powers, gain and efficiency).

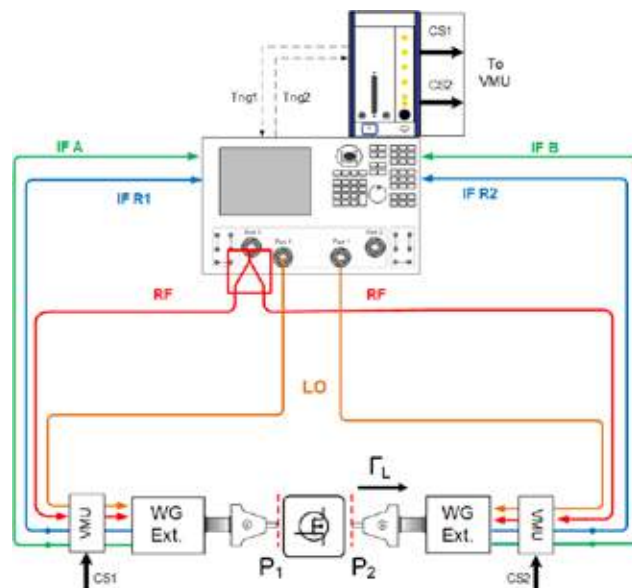

Figure 6: Simplified schematic of a load-pull architecture controllable with MMW-STUDIO LP

MT920A MMW-STUDIO – High resolution power control for S-parameters and gain compression power sweep measurements

MMW-STUDIO is the base module required for high resolution power control for S-parameters and gain compression power sweep measurements. It consists of the following capabilities:

- > Instrument control² (VNA, power meter, bias control)
- > Millimeter-wave VNA configuration (compatible with most commercial mm-wave extenders up to 1.1 THz)
- > Full calibration routine
- > Frequency, power and bias (up to two bias sources) sweeps
- > Small-signal measurements (standard/power-controlled S-parameters)
- > Large-signal measurements (P_{out} , P_{in} , P_{avs} , G_t , G_p , E_{ff} , PAE, V_{in} , V_{out} , I_{in} , I_{out}) at 50Ω

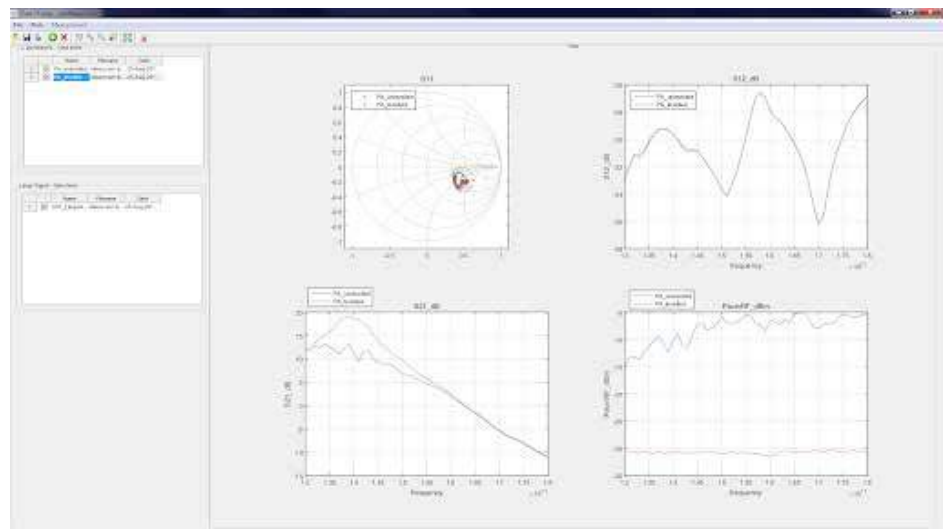

Figure 7: Measurements of S-parameters of a two-stage power amplifier in the frequency range between 130 GHz and 180 GHz, without power levelling (blue) and with power levelling (red).

² Please see list of compatible devices

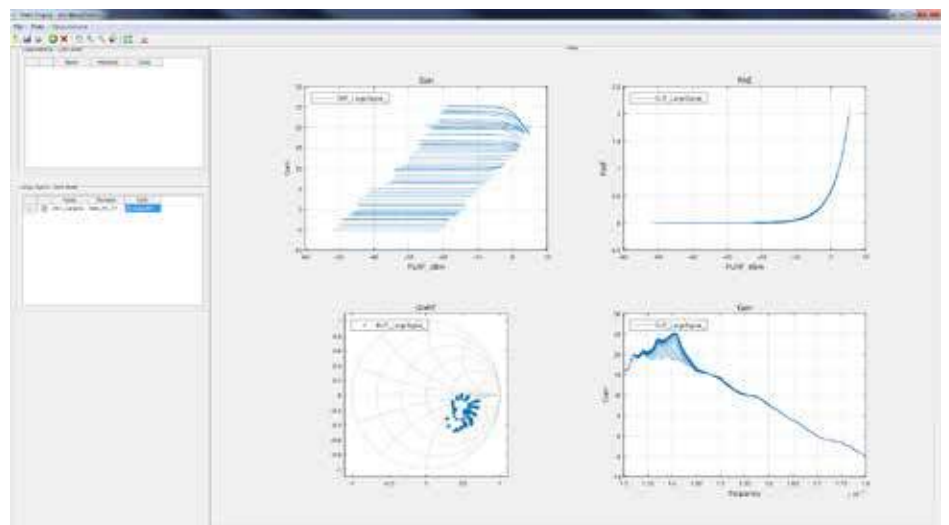

Figure 8: Large signal (power sweep) measurement of a two-stage power amplifier, at multiple frequencies (51 in the range 130 GHz to 180 GHz) for an input power range between -45 and -13 dBm

MT920B MMW-STUDIO LP – Active load pull at millimeter-wave and sub-THz frequencies add-on

MT920B MMW-STUDIO LP is an add-on option to MT920A MMW-STUDIO which enables active load-pull measurements. In addition to the capabilities of the base module MMW-STUDIO, MMW-STUDIO LP provides:

- > Additional instrument control (VMU, DACs)
- > Fundamental load impedance control
- > Large-signal measurements (P_{out} , P_{in} , P_{avs} , G_r , G_p , E_{fp} , PAE, V_{in} , V_{out} , I_{in} , I_{out}) at any controlled load impedance

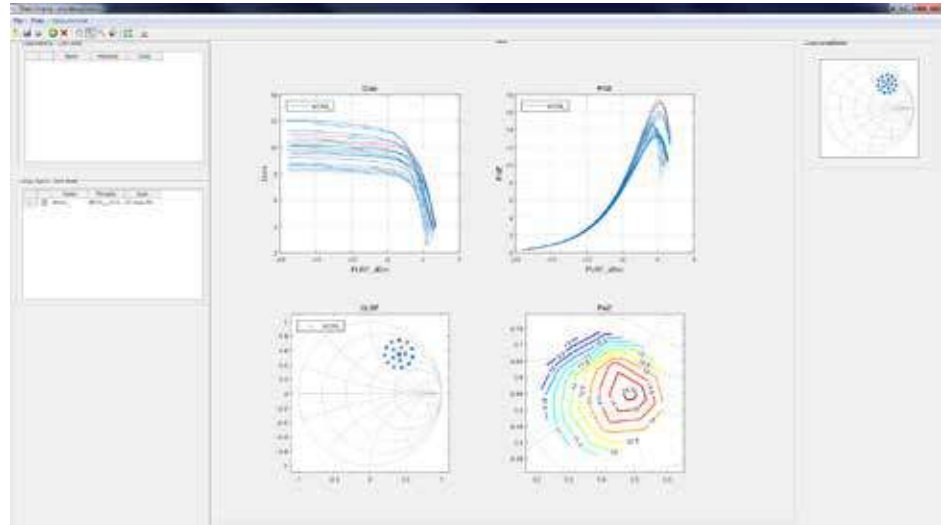

Figure 9: Data Display, showing results an active load-pull measurement of a SiGe 130nm HBT over 15 loading condition, at 75 GHz, for a set input power sweep from -30 to -2 dBm. In the plots: Power gain vs. power delivered to the load, PAE vs available power at the input, measured load impedances, PAE contour at P1dB.

Note: a VMU is required to perform active load pull using MMW-STUDIO LP

MT920C MMW-STUDIO DD –Data display

MT920C MMW-STUDIO DD is the standalone version of the data display GUI and allows visualization and data analysis of measurements performed with MMW-STUDIO and MMW-STUDIO LP.

Hardware (VMU) models

A Vector Modulator Unit (VMU) is a required accessory for MMW-STUDIO LP in order to perform millimeter-wave and sub-THz active load pull.

VMU201802

VMU201802 are vector modulator units that are mounted on top of the waveguide extender modules. A single VMU201802 connects to a one waveguide extended module, and hence two VMUs are required per system.

| | Min. | Typ. | Max. | Ext. |
|-----------------|-------|------------|--------|------------|
| Pin | 4 dBm | 8 dBm | 13 dBm | - |
| Pout | - | - | 13 dBm | - |
| Frequency range | - | 8 - 18 GHz | - | 5 – 20 GHz |
| Vdc I,Q (abs) | 0 V | - | 1 V | - |

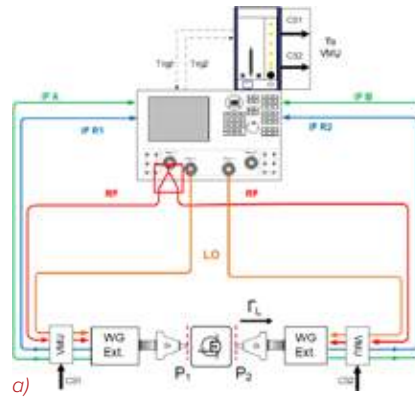

a) Figure 10:

a) Basic schematic architecture of the MMW-STUDIO LP employing VMU201802.



b)

b) Example of system implementation for load-pull measurements using MMW-STUDIO; 2x VMU201802 are mounted directly on WR10 OMLN5260-60003 extender.



a)

Figure 11:

a) Example of VMU201802 casing (please notice, color and dimension may slightly change).



b)

b) Mounting detail of a VMU201802 on an OML N5260-60003 extender.

VMU201901

VMU201901 are vector modulator units that are mounted in a standard 19" rack. A single VMU201901 connects to two waveguide extender modules, and hence only one VMU is required per system.

| | Min. | Typ. | Max. | Ext. |
|-----------------|-------|------------|--------|------------|
| Pin | 9 dBm | 13 dBm | 17 dBm | - |
| Pout | - | - | 10 dBm | - |
| Frequency range | - | 8 - 18 GHz | - | 5 – 20 GHz |
| Vdc I,Q (abs) | 0 V | - | 1 V | - |

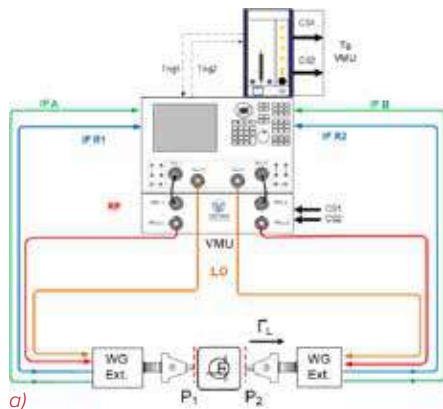

a)

Figure 12:

a) Basic schematic architecture of the MMW-STUDIO LP employing VMU201901.



b)

b) Example of system implementation for load-pull measurements using MMW-STUDIO LP and VMU201901. The VMU is now a single rack-mount box, fixed under the VNA. In this setup, VDI VNAX WR6.5 extenders are used.

Typical system performance

The performance of an millimeter-wave active load pull system (i.e. absolute power control, power handling, dynamic range, stability of power and impedance, etc.) is highly dependent on the specific millimeter-wave VNA system used and is influenced by both the VNA and the waveguide extender modules, and can vary from system to system.

The following table shows typical performance measured on commercially available VNAs and extender modules.

| Frequency (GHz) | Stability of Amplitude $\sigma(\Gamma)$ | Stability of Phase $\sigma(\angle\Gamma)$ (deg) |
|-----------------|--|--|
| 96 | 0.002 | 0.05 |
| 140 | 0.0035 | 0.33 |
| 180 | 0.0016 | 0.17 |
| 288 | 0.001 | 0.29 |
| 500 | 0.0046 | 0.57 |

Reported performances:

- > Stability of $|\Gamma_L|$: reports the capability to reproduce a certain loading condition, and the variation on the absolute value, at a specific frequency, over 100 measurements, averaged over four different points on the Smith Chart. This value is reported as an absolute standard deviation (std).
- > Stability of $\angle\Gamma_L$: reports the capability of reproduce a certain loading condition, and the variation on the phase (in degrees), at a specific frequency, over 100 measurements, averaged over four different points on the Smith Chart. This value is reported as an absolute standard deviation (std).

Supported instrumentation

VNA

- > Keysight N5222A or N5222B (or higher frequency) PNA with options 401 and 080/S93080A/S93080B
- > Keysight N5242A or N5244B (or higher frequency) PNA-X with options 400 and 080/S93080A/S93080B
- > Rohde & Schwarz ZNA26 (or higher frequency) with 4-ports and options B16, K4 and K8

Power meters

- > Keysight/Agilent/HP E4418/19A/B EPM Series Power meter
- > Keysight N1913/14A EPM Series Power meter
- > Erickson/VDI PM4 and PM5

DC sources/Parameter Analyzers

- > Keysight/Agilent E5270B
- > Keysight/Agilent HP4142B
- > Keysight/Agilent 66xxA
- > Keysight/Agilent 662xA
- > Keysight/Agilent E364xA
- > Keysight/Agilent E3631A
- > Keysight/Agilent E5260
- > Keysight/Agilent N57xx
- > Keysight/Agilent B2900
- > Keysight/Agilent/HP 4156C
- > Keithley 2400 series

DACs

- > NI PXIe-4463
- > NI PXI-6733
- > NI PXI-5422

Note: supported instrumentation is being continuously updated. Please contact us for a list of the latest instruments, or to request support for an unsupported instrument.

ATSv5 Automated Tuner System Software

MT993 SERIES



MT993B

Noise Characterization Application Software

General

The MT993B noise characterization application software is designed to operate with ATS tuners and determine the noise parameters of a linear device, module or sub-assembly. The program is provided as part of an ATS system specified for noise characterization separately as model MT993B.

Noise Parameters

Good noise performance is a critical element of most receiving systems. Knowledge of the noise parameters which define the noise performance of a device can be an invaluable aid to the receiver/amplifier designer by saving hours of design time and reducing, or even eliminating, “cut-and-try” iterations.

An ATS system, operating with the Maury noise application software, can provide fast, accurate measurements of minimum noise figure, optimum source reflection coefficient, and equivalent noise resistance. The program will also provide the gain parameters of the device and has a built-in general purpose S-parameter measurement program. All measurements can be de-embedded to the device input and output planes. The software provides for both data and graphical hard copy outputs.

Interactive Measurement Mode

This is a single frequency display that permits the user to: a) measure the device noise parameters; b) measure noise figure and gain at any available source impedance; c) select the noise parameter measurement method; and d) select the impedances used in the noise parameter determination or let the software determine these automatically. Constant noise figure and gain circles can also be plotted on the source impedance Smith Chart. An advanced sweep plan is available to define fully-automated, multi-frequency, multi-bias noise characterization projects.

Swept Noise Display

The measured parameters can be simultaneously displayed versus frequency and bias. A mouse or cursor key controlled marker provides for readouts at measured or interpolated points. Data smoothing (1st or 2nd order) is available, and graphics scales are user-controlled. Noise parameters as well as maximum gain, associated gain and stability factor (k) are tabulated and available for printout below the plots.

Noise Statistics Display

This is a statistics window screen which shows agreement between the noise parameter solution and individual points. The noise parameter solution is also displayed so the effect of changing options can be immediately seen. This display may be toggled between calibration and DUT measurement data so the effect of calibration options can be seen on the measured DUT data.

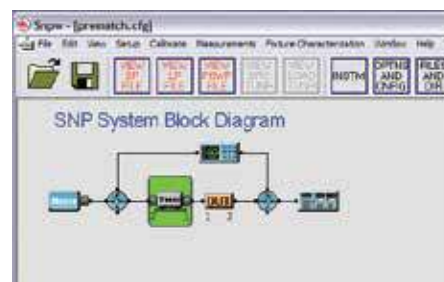

Typical setup for performing noise characterization measurements.

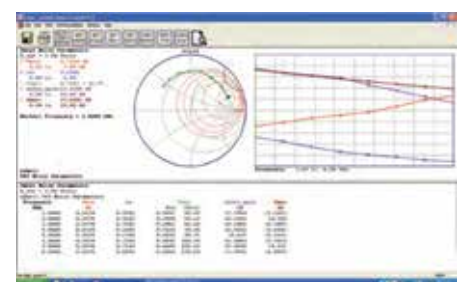

Typical swept noise display.



DATA SHEET
4T-020B

MT993B01

High-Speed Noise Parameter Measurement Option

General

The MT993B01 high-speed noise parameter measurement option (patent pending) operates with the MT993B noise characterization application software and Keysight's PNA-X to take advantage of the built-in noise receiver and fast sweep capability of the analyzer. This typically speeds up the calibration and measurement time by 200X – 400X; making it practical to sweep a much larger frequency set. Typical test bench setups are simplified (as shown in the photograph below), which reduces the number of cables and connections, thus helping to stabilize the setup. This setup produces data that is smoother and has less scatter than traditional methods of noise measurement. The fast measurement speed eliminates temperature drift, and using a VNA with an internal noise receiver simplifies the setup and makes it much more stable and consistent.

Benefits and Features

The MT993B01 option includes two key features that contribute to the breakthrough speed improvement: 1) The ATS tuner is characterized with one set of states (physical tuner positions) that are selected to give a reasonable impedance spread over the frequency band of interest; and 2) the noise power measurement is swept over the frequency range at each state, so that the tuner only moves to each position once; thereby minimizing tuner movement.

The much higher speed makes it practical to always do a full in-situ calibration to minimize errors, and to measure more frequencies to get a better view of scatter and cyclical errors, and to be able to use smoothing with more confidence. The higher frequency density also enhances accuracy by reducing shifts due to aliasing.



Typical setup for performing high-speed noise parameter measurements.

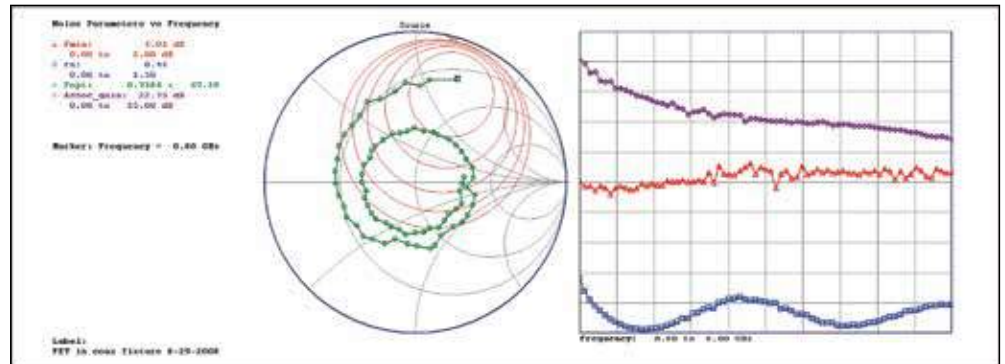

Measured noise parameter data using MT993B01 (no smoothing).

Programmers Addition (MT993E)

MT993E is an option which allows external control of ATS software through a programming interface called SNP DLL. MT993E is useful for users that want to control ATS from a third party application such as C++, C#, LabVIEW or MATLAB.

System Control Option (MT993F)

MT993F is an option that extends the capability of MT993B to provide automated switching between S-parameters and Noise Parameters from a single setup.

MT993F is required when using switches for Noise Parameter measurements. Switches can be external, integrated into NSM/NRM, or integrated inside the measurement instrument (i.e. Keysight Technologies PNA-X).

DC I-V Curve Option (MT993G)

MT993G is an option that extends the capability of MT993B to provide for automatic measurement and display of device DC current-voltage curves. For FET devices, the measurement display is a family of output current versus output voltage curves with input voltage as the parameter. For bipolar devices, the measured display is a family of output current versus output voltage curves with input current as the parameter. A maximum dissipation value can be entered which will cause each sweep to terminate when that condition is reached.

Fixture Characterization Option (MT993J)

MT993J is a standalone option that enables the S-Parameters of a test fixture or probe setup to be determined from two network analyzer calibrations. First, a 2-port calibration at the coaxial cable reference plane (or similar) is performed; second, a 2-port calibration at the DUT reference plane is performed. The resulting calibrations are mathematically compared and two separate S-Parameter files, each one representing a fixture half, are generated.

Automated Mobile Testing System Software (AMTS)

MT910 SERIES



Introduction

Mobile phones must guarantee proper functioning in non-ideal real-world environments, such as a lost or damaged antenna, usage in a tunnel or locker, being held close to the body or in a pocket surrounded by coins, etc. Each of these scenarios can be regarded as non-ideal from an RF standpoint, meaning non-50Ω. We are able to use a single tuner to vary the VSWR magnitude and phase seen by the antenna port of the phone and test its performance in transmit and receive mode.

The Maury Automated Mobile Test System Software (AMTSv3) is a standalone application designed specifically to automate the testing of mobile phones in transmit and receive modes, for output power and sensitivity respectively, as a function of VSWR magnitude and phase.

What AMTSv3 Can Do For You

AMTSv3 offers a simple, fast and cost-effective solution tailored for mobile phone testing outside of the 50Ω environment. This solution automates mobile phone testing in TX/RX modes over a multitude of channels/frequencies, battery voltages and power levels. It works by combining:

- > Maury's MT910 Series Automated Mobile Testing System software to
 - > Control the system
 - > De-embed VSWR and power levels to DUT reference
 - > Control variable DC supply to mimic battery voltages
 - > Automate measurements
- > A Maury MT98x Automated Tuner, which sets non-50Ω impedance; and
- > A Keysight or Rohde & Schwarz Wireless Communications Test Set, which (acting as a base station) sets active channel and power levels, and measures power and bit-error-rate.

- > If thermal stability issues exist
- > If your phone's design is acceptable as is, or if some components need to be redesigned
- > If specific performance problems result from batch manufacturing

These are just a few of the ways you can use Maury MT910 AMTS software and ATS tuners to extend your mobile phone testing capability beyond the 50Ω environment.

Available Models Supported Wireless Data Communications Standards

| Model | Description (See details on page 216) |
|--------|---------------------------------------|
| MT910* | Mobile Phone Tester |
| MT910A | GSM Standard |
| MT910B | WCDMA Standard |
| MT910C | CDMA2000 Standard |
| MT910D | LTE Standard |
| MT910E | TD-SCDMA Standard |

**MT910 requires at least one standard (MT910A, MT910B, MT910C, MT910D or MT910E).*

By analyzing the test results obtained using this solution you can learn:

- > What level of antenna mismatch is acceptable, based on real-life testing against your VSWR requirements
- > If your mobile phone meets the minimum performance requirements under pre-defined VSWR and voltage conditions
- > If your phone's performance degrades after a large VSWR sweep plan



DATA SHEET
4T-021

MT910: Mobile Phone Tester

Transmit Load Pull — The goal of load pull in the phone's transmit mode is to measure the output power as a function of VSWR magnitude and phase. A Wireless Communication Test Set is used in signaling mode to establish a call with a mobile phone, specify a channel/frequency (e.g., ARFCN 128 is 824 MHz uplink and 869 MHz downlink for GSM850), set the power control level (e.g., PCL 5 is 33 dBm at GSM850) and measure the power delivered from the phone at given VSWR magnitude and phase.

Receive Load Pull — The goal of load pull in RX mode is the sensitivity-measurement of the phone; at what power level will a user-specified bit-error rate (BER) be achieved, as a function of VSWR magnitude and phase. A Wireless Communication Test Set is used in signaling mode to establish a call with a mobile phone, specify a channel/frequency, and send a low-power burst (in the order of -105 to -110 dBm) to the phone and measure the resulting BER. Maury MT910 series software will vary the burst-power until the required BER is achieved.

Manual Testing — Simple manual testing is achieved by entering single values of channel/frequency, battery voltage, VSWR magnitude and phase.

Test Automation — The measurement routine is automated thanks to the use of an advanced graphic test sequencer which allows the user to enter a list of channels/frequencies, battery voltages, VSWR magnitudes and phases.

Compatible Instruments — Keysight 8960, Keysight E7515A UXM, R&S CMU200, R&S CMW500.

MT910A: GSM Standard

Adds GSM Standard to MT910 Mobile Phone Tester

Supported Technology: GSM 850,900,1800,1900.

Measurements Supported:

- > TX power – Transmit Power
- > Modulation – Frequency Error & Phase Error (RMS & PEAK)
- > Spectrum – due to Modulation [23 frequencies]
 - > Due to Switching [9 frequencies]
- > Sensitivity (search algorithm w/ adjustable start level)
 - > 2.439% RBER

MT910B: WCDMA Standard

Adds WCDMA Standard to MT910 Mobile Phone Tester

Supported Technology: WCDMA Bands I, II, V, VI, VIII

Measurements Supported:

- > TX power – Transmit Power
- > Modulation – Freq Error, MAG Error, Phase Error, EVM (Avg)
- > Spectrum – ACLR at 5 and 10 MHz [+ and –]
- > Sensitivity (search algorithm w/ adjustable start level)
 - > 0.1% BER

MT910C: CDMA2000 Standard

Adds CDMA2000 Standard to MT910 Mobile Phone Tester

Supported Technology: CDMA2000 BC0, BC1

Measurements Supported:

- > TX power – Transmit Power
- > Modulation – Carrier Frequency Error, Waveform Quality
- > Spectrum – ACP at 870, 885, 900 & 1,980 MKz [+ and –]
- > Sensitivity (search algorithm w/ adjustable start level)
 - > 0.5% FER with Confidence Level >95%

MT910D: LTE Standard

Adds LTE Standard to MT910 Mobile Phone Tester

Supported Technology: LTE Standard

Measurements Supported:

- > TX power – Transmit Power
- > Modulation – EVM, Mag Error, Phase Error, Frequency Error, IQ Offset
- > Spectrum – ACLR at UTRA frequencies
- > Sensitivity (search algorithm w/ adjustable start level)
 - > 5.0% BER

MT910E: TD-SCDMA Standard

Adds TD-SCDMA Standard to MT910 Mobile Phone Tester

Supported Technology: TD-SCDMA Standard

Measurements Supported:

- > TX power – Transmit Power
- > Modulation – EVM, Mag Error, Phase Error, Frequency Error
- > Spectrum – ACLR at ± 1.6 MHz and ± 3.2 MHz
- > Sensitivity (search algorithm w/ adjustable start level)
 - > 0.5% BER

Automated Tuners

GENERAL INFORMATION



What is load pull?

Load Pull is the act of presenting a set of controlled impedances to a device under test (DUT) and measuring a set of parameters at each point. By varying the impedance, it is possible to fully characterize the performance of a DUT and use the data to:

- > Verify simulation results of a transistor model (model validation)
- > Gather characterization data for model extraction (behavioral model extraction)
- > Design amplifier matching networks for optimum performance (amplifier design)
- > Ensure a microwave circuit's ability to perform after being exposed to high mismatch conditions (ruggedness test)
- > Confirm the stability or performance of a microwave circuit or consumer product under non-ideal VSWR conditions (stability/performance/conformance/antenna test)

Example of load pull measurements with Output Power (Pout) contours plotted on a Smith Chart.

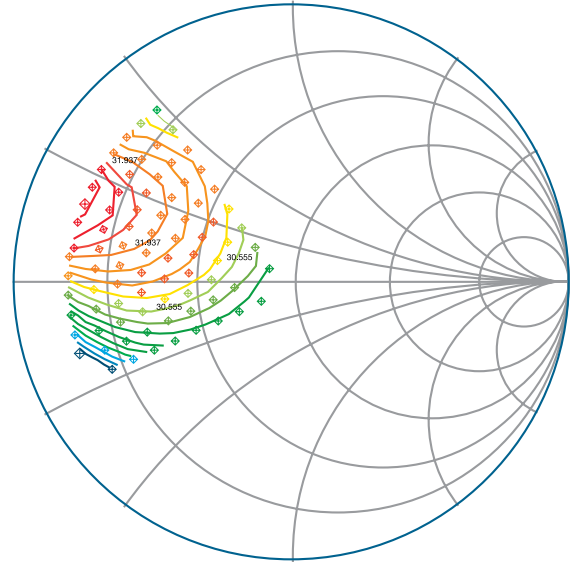

Iso Pout Contours Measured @ 1.85 GHz

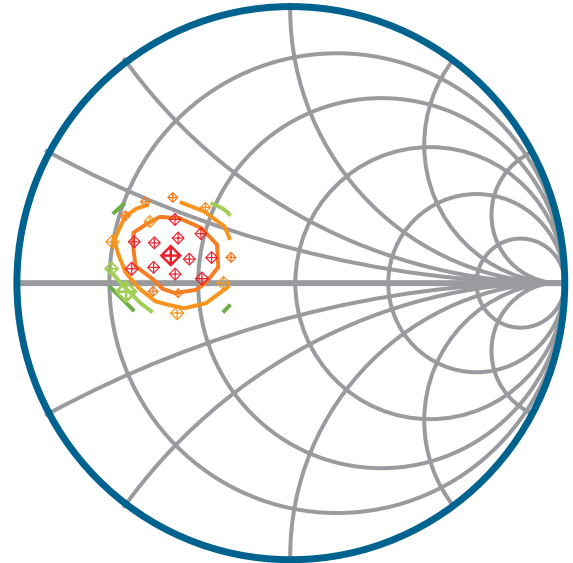

Iso Pout Contours Simulated @ 1.85 GHz

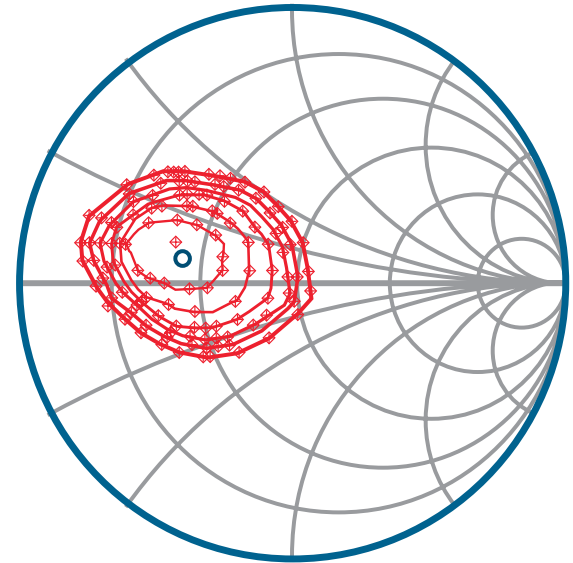

Slide-Screw Impedance Tuner

One tool available to vary the impedances presented to a DUT is the slide-screw impedance tuner. The slide-screw tuner is based on a 50Ω slabline and a reflective probe, sometimes referred to as a slug. Ideally, when the probe is fully retracted, the tuner presents a near- 50Ω impedance represented by the center of a normalized Smith Chart. As the probe is lowered into the slabline (Y-direction) it interrupts the electric field that exists between the center conductor and walls of the slabline, reflects some

of the energy back towards the DUT, creates a capacitance and increases the magnitude of reflection (represented by the red curve on the Smith Chart at right). As the probe travels along the slabline (X-direction), the distance between the probe and the DUT is altered, thereby rotating the phase of the reflection (represented by the blue curve on the Smith Chart). It is therefore possible to recreate nearly any arbitrary impedance without the need of discrete components (lumped elements or transmission lines).

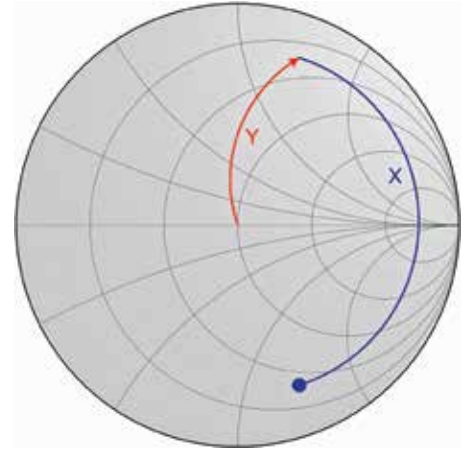

Simplified representation of a slide-screw tuner.

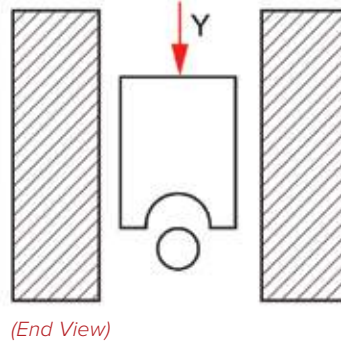
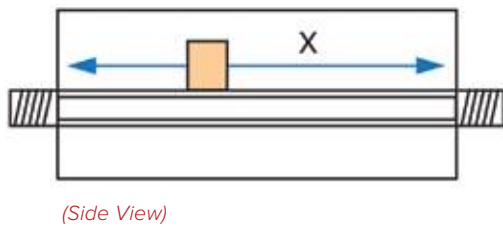

The probes used in slide-screw tuners are wideband in nature, and have similar reflective properties over a wide range of frequencies. In order to increase the overall useful bandwidth of the tuner, two probes of varying dimensions are independently used within a tuner; one for low frequencies and one for high frequencies. In this manner, it is common for slide-screw tuners to achieve an overall frequency range of several octaves to over a decade.

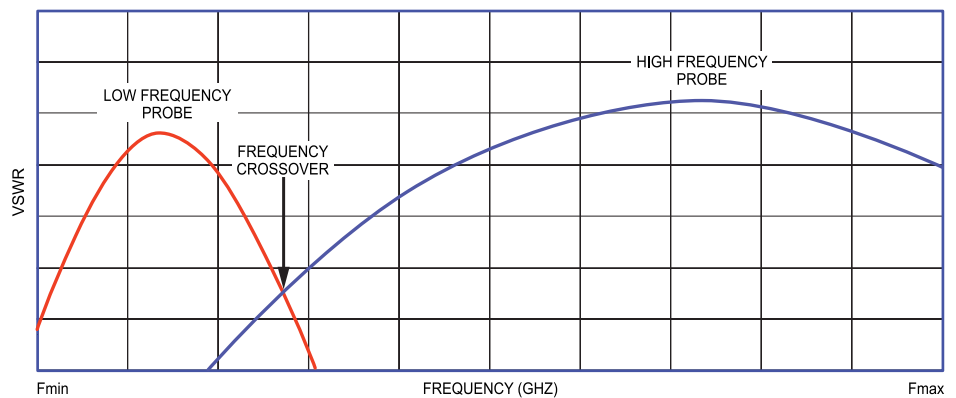

VSWR versus Frequency of a two-probe slide-screw tuner.

Pre-Calibration (Pre-Characterization)

Slide-screw tuners are available in both manual and automated varieties. While they both work on the same slabline and capacitive probe technique, automated tuners have the ability to be pre-calibrated. Pre-calibration involves recording the s-parameters of each probe at varying X and Y positions for the frequencies of interest using a calibrated vector network analyzer. In general, X and Y positions are selected such that an even distribution of impedances are recorded over the Smith Chart. Once the calibration data is stored in a lookup table, the VNA is no longer required to use the tuner; the tuner 'knows' how to present impedances accurately without VNA verification.

Tuner Repeatability

Tuner repeatability is defined as the vector difference between the pre-calibrated s-parameter data and subsequent s-parameter measurements after movement, when returning the probe to a given X and Y position. Since the impedances presented to the DUT are reliant on the tuner's ability to accurately return to pre-calibrated states, repeatability is a critical tuner characteristic that affects the reliability of measurement data. In order to guarantee a high level of repeatability, precision

mechanics and motors within the tuner are used to return the probe to its pre-calibrated positions with s-parameter vector differences of -40 to -50 dB or better (see specific tuner model pages 223-228 for typical repeatability graphs).

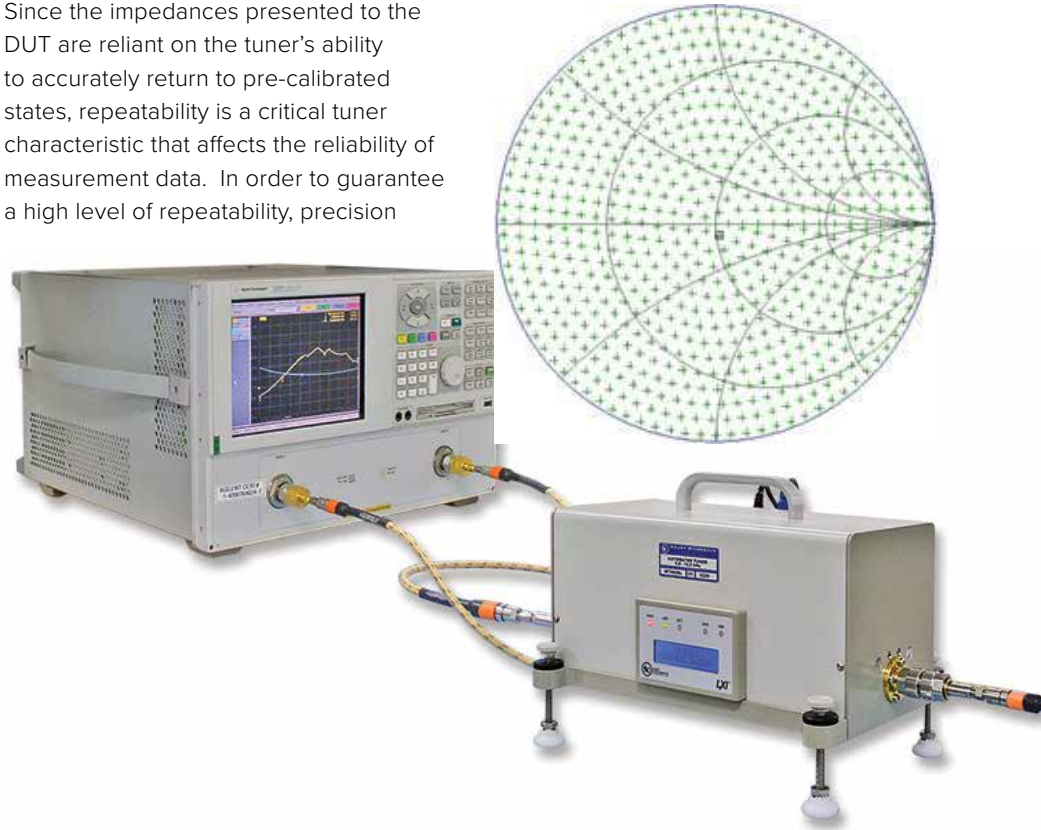

Tuning Accuracy and Interpolation

During pre-calibration, the tuner's s-parameters are recorded at a user-definable number (normally between 300-3000) of X and Y positions giving an even distribution over the Smith Chart. However, an arbitrary load impedance that falls between pre-calibrated states might be required. To achieve a high level of accuracy, a two-dimensional algorithm is used to interpolate between the closest pre-calibrated impedances

in order to determine the new physical X and Y positions of the desired interpolated impedance. Interpolation increases the number of tunable impedances well beyond the initial pre-calibration range.

Given a sufficiently dense pre-calibration look-up table, a tuner's repeatability (ability to return to pre-calibrated states) and accuracy (ability to interpolate between pre-calibrated states) offer similar performances.

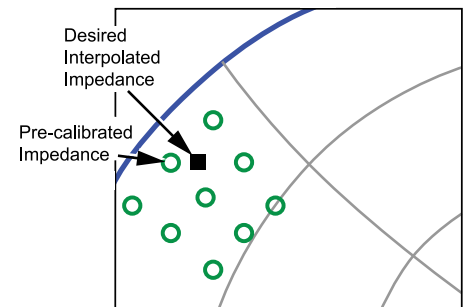

Patented LXI™-Certified Embedded Tuner Controller

(U.S. Patent No. 8,823,392)

All Maury slide-screw automated impedance tuners are equipped with a patented embedded LXI™-certified controller (U.S. Patent No. 8,823,392) with onboard microprocessor and memory. After pre-calibration, the lookup table is copied onto the tuner's embedded flash memory storage, as are any s-parameter files of passive components that will be used with the tuner (adapters, cables, fixtures, probes, attenuators...). The tuner's onboard microprocessor will use the lookup table and component s-parameter blocks to calculate the probe positions required to present an arbitrary load impedance taking into account (de-embedding) all adapter/fixture losses between the tuner and DUT, and all

back-side losses between the tuner and the measurement instrument, as well as possible non-50Ω terminations.

An integrated web interface allows for easy point-and-click tuning, tuner control settings including IP address and firmware upgrade.

Direct ASCII commands can be sent through raw TCP/IP interface over Ethernet or USB and used with any socket programming language or through any Telnet client program in any operating system. Commands include direct impedance tuning, reference-plane shifting, VSWR testing and more.

| Parameter | Value |
|-----------------------|-------------------------------------|
| Manufacturer | Maury Microwave Corporation |
| Instrument Model | MT982-EL30 |
| Serial Number | 5270 |
| Firmware Revision | 3.4-1.24 |
| Description | Maury MT982-EL30 - 5270 |
| LXI Extended Features | LXI Core Functions |
| LXI Version | 1.4 |
| mDNS-Hostname | 169.254.6.77, MT982-EL30-5270.local |
| IP Address | 169.254.6.77 |
| MAC Address | fc:6c:31:00:00:e6 |
| Device Address | TCPIP0::169.254.6.77::5025::SOCKET |
| Telnet Address | telnet://169.254.6.77:5024 |

| Parameter | Currently in use |
|---------------------|-------------------------|
| VXI-11 Discovery | On |
| mDNS Discovery | On |
| DHCP | On |
| Auto-IP | On |
| Network-Hostname | MT982-EL30-5270.local |
| IP Address | 169.254.6.77 |
| Netmask | 255.0.0.0 |
| Gateway | 0.0.0.0 |
| Dynamic DNS Updates | On |
| Manual DNS | Off |
| Domain | Belkin |
| Primary DNS | 10.10.1.17 |
| Secondary DNS | 10.10.1.19 |
| Description | Maury MT982-EL30 - 5270 |
| Web Password | hidden |

Edit Configuration

LXI™ Tuners Frequency Graph

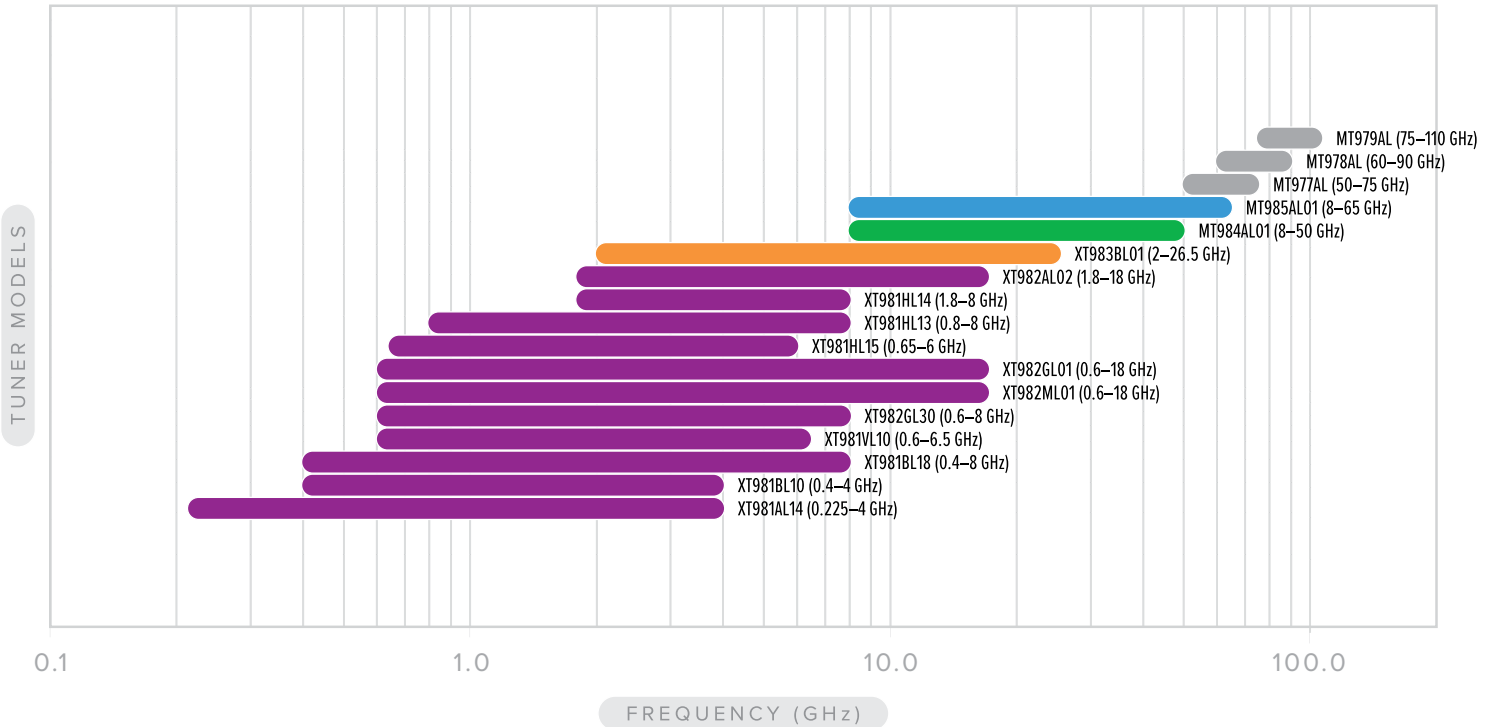

*Proposed IEEE P287
High Frequency
Connector Color Code*



7mm



3.5mm



Waveguide



2.4mm



1.85mm

High-Gamma™ & High-Power LXI™ - Certified Automated Tuners

225 MHz TO 8 GHz



Products covered by one or more of the following patents
9,209,786 / 8,823,392 / 7,589,601 B2



Specifications

Frequency Range -- See Available Models Table
VSWR Matching Range -- See Available Models Table
Step Size (Probes) -- 7.8 microinches¹
Step Size (Carriage) -- 234.4 microinches¹
Connectors: -- Precision 7mm²

Accessories Provided

Each XT981()L series tuner is provided with one (1) MT1020F power supply, one (1) USB cable, one (1) Ethernet cable, one (1) USB to Ethernet adapter, and one (1) operating manual.

Recommended Accessories

2698C2 Torque Wrench
A028D 7mm Connector Gage Kit
8022S1/8022T1 Precision 7mm/3.5mm (Female & Male) Adapters

Available Models

| Model | Frequency Range (GHz) | Matching Range | | Power Capability ⁴ | Vector Repeatability (Minimum) | Insertion Loss (Probes Fully Retracted) | Mating Surface Dimensions |
|-----------|-----------------------|----------------|----------------------|-------------------------------|--------------------------------|---|---------------------------|
| | | Minimum | Typical ³ | | | | |
| XT981HL13 | 0.80 – 6.5 | 100:1 | 200:1 | 250 W CW 2.5 kW PEP | –40 dB | 0.3 dB | 18.51" [47.02 cm] |
| | 6.5 – 8.0 | 60:1 | 100:1 | | | | 12.5" [31.75 cm] |
| XT981HL14 | 1.8 – 8.0 | 100:1 | 200:1 | | | | 24.51" [62.26 cm] |
| XT981HL15 | 0.65 – 6.0 | | | | 37.01" [94.01 cm] | | |
| XT981AL14 | 0.225 – 4.0 | 15:1 | 25:1 | | –50 dB | | 24.51" [62.26 cm] |
| XT981BL10 | 0.40 – 4.0 | | | | –40 dB | | 18.51" [47.02 cm] |
| XT981BL18 | 0.40 – 8.0 | | | | 10:1 | | –50 dB |
| XT981VL10 | 0.60 – 5.5 | 40:1 | 50:1 | | | | |
| | 5.5 – 6.5 | 25:1 | | | | | |

¹ Based on microstepping (1/16) the drive motors.

² Precision 7mm per Maury data sheet 5E-060.

³ Defined as the minimum VSWR over 70% of the frequency range.

⁴ Power rated at maximum VSWR.



DATA SHEET
4T-050G06

7mm LXI™-Certified Automated Tuners

0.6 TO 18 GHZ



Products covered by one or more of the following patents
9,209,786 / 8,823,392 / 7,589,601 B2



Specifications

Frequency Range -- See Available Models Table
VSWR Matching Range -- See Available Models Table
Step Size (Probes) -- 7.8 microinches¹
Step Size (Carriage) -- 62.5 microinches¹
Connectors -- Precision 7mm²

Accessories Provided

Each tuner is provided with one (1) MT1020F power supply, one (1) USB cable, one (1) Ethernet cable, one (1) USB to Ethernet adapter, and one (1) operating manual.

Recommended Accessories

2698C2 Torque Wrench
A028D 7mm Connector Gage Kit
8022S1/8022T1 Precision 7mm/3.5mm (Female & Male) Adapters

Available Models

| Model | Frequency Range (GHz) | Matching Range | | Power Capability ⁴ | Vector Repeatability (Minimum) | Insertion Loss (Probes Fully Retracted) | Mating Surface Dimensions |
|-----------|-----------------------|----------------|----------------------|-------------------------------|--------------------------------|---|---------------------------|
| | | Minimum | Typical ³ | | | | |
| XT982GL01 | 0.6 – 18.0 | 10:1 | 18:1 | 50 W CW 0.5 kW PEP | –40 dB | 0.5 dB | 17.92" [45.52 cm] |
| XT982GL30 | 0.6 – 2.0 | 30:1 | 40:1 | | | | |
| | 2.0 – 8.0 | 15:1 | 20:1 | | | 0.4 dB | 10.92" [27.74 cm] |
| XT982AL02 | 1.8 – 18.0 | 15:1 | 20:1 | | | | |

¹ Based on microstepping (1/16) the drive motors.

² Precision 7mm per Maury data sheet 5E-060.

³ Defined as the minimum VSWR within 70% of the frequency range.

⁴ Power rated at maximum VSWR.



DATA SHEET
4T-050G07

3.5mm LXI™ -Certified Automated Tuners

2 TO 26.5 GHZ



Products covered by one or more of the following patents
9,209,786 / 8,823,392 / 7,589,601 B2



Specifications

Frequency Range -- 2-26.5 GHz
VSWR Matching Range -- 10:1
Step Size (Probes) -- 7.8 microinches¹
Step Size (Carriage) -- 62.5 microinches¹
Connectors -- Precision 3.5mm, male/female²

Accessories Provided

Each tuner is provided with one (1) MT1020F power supply, one (1) USB cable, one (1) Ethernet cable, one (1) USB to Ethernet adapter, and one (1) operating manual.

Recommended Accessories

8799A1 Torque Wrench
A050A 2.92mm/3.5mm Digital Connector Gage Kit

Available Models

| Model | Frequency Range (GHz) | Matching Range | | Power Capability ⁴ | Vector Repeatability (Minimum) | Insertion Loss (Probes Fully Retracted) | Connector Type | Mating Surface Dimensions |
|-----------|-----------------------|----------------|----------------------|-------------------------------|--------------------------------|---|---------------------|---------------------------|
| | | Minimum | Typical ³ | | | | | |
| XT983BL01 | 2.0 – 26.5 | 10:1 | 15:1 | 25 W CW 250 W PEP | -40 dB | 0.6 dB | 3.5mm (male/female) | 10.13" [25.73 cm] |

¹ Based on microstepping (1/16) the drive motors.
² Precision 3.5mm per Maury data sheet 5E-062.

³ Defined as the minimum VSWR over 70% of the frequency range.

⁴ Power rated at maximum VSWR.



2.4mm & 1.85mm LXI™-Certified Automated Tuners

8 TO 65 GHZ



Products covered by one or more of the following patents
9,209,786 / 8,823,392 / 7,589,601 B2



Specifications

Frequency Range -- See Available Models Table
VSWR Matching Range -- 10:1
Step Size (Probes) -- 31 microinches¹
Step Size (Carriage) -- 50 microinches¹
Connectors -- See Available Models Table

Accessories Provided

Each tuner is provided with one (1) MT1020F power supply, one (1) USB cable, one (1) Ethernet cable, one (1) USB to Ethernet adapter, and one (1) operating manual.

Recommended Accessories

8799A1 Torque Wrench
A048A 2.4mm/1.85mm Digital Connector Gage Kit

Available Models

| Model | Frequency Range (GHz) | Matching Range | | Power Capability ³ | Vector Repeatability (Minimum) | Insertion Loss (Probes Fully Retracted) | Connector Type | Mating Surface Dimensions |
|-----------|-----------------------|----------------|----------------------|-------------------------------|--------------------------------|---|----------------------|---------------------------|
| | | Minimum | Typical ² | | | | | |
| MT984AL01 | 8.0 – 50.0 | 10:1 | 20:1 | 10 W CW 100 W PEP | -40 dB | 0.60 dB | 2.4mm (male/female) | 5.47" [13.88 cm] |
| MT985AL01 | 8.0 – 65.0 | | | | | 1.15 dB | 1.85mm (male/female) | |

¹Based on 1/2 stepping the drive motors.

² Defined as the minimum VSWR within 70% of the frequency range.

³ Power rated at maximum VSWR.

Millimeter-Wave LXI™-Certified Automated Tuners

50 TO 110 GHz



MT977AL
LXI™ Automated Tuner
U.S. Patent No. 5,910,754
International Patents Pending

Specifications

Frequency Range -- See Available Models Table
VSWR Matching Range -- See Available Models Table
Step Size (Probes) -- 0.5 microinches¹
Step Size (Carriage) -- 0.5 microinches¹
Flanges -- MPF15 (WR15), MPF12 (WR12) and MPF10 (WR10)²

Accessories Provided

Each tuner is provided with one (1) MT1020F power supply, one (1) USB cable, one (1) Ethernet cable, one (1) USB to Ethernet adapter, one (1) MT979C12 tuner control cable, and one (1) operating manual.

Available Models

| Model | Frequency Range (GHz) | Matching Range | | Power Capability ⁴ | Vector Repeatability (Minimum) | Insertion Loss ⁵ (Maximum) | Dissipative Loss ⁶ (Maximum) |
|---------|-----------------------|----------------|----------------------|-------------------------------|--------------------------------|---------------------------------------|---|
| | | Minimum | Typical ³ | | | | |
| MT977AL | 50.0 — 75.0 | 20:1 | 30:1 | 20 W CW 200 W PEP | -40.0 dB | 0.35 dB | 7.0 dB |
| MT978AL | 60.0 — 90.0 | | | | | 0.5 dB | |
| MT979AL | 75.0 — 110.0 | | | | | 0.6 dB | |

¹ Based on 1/2 stepping the drive motors.

² Maury Precision Flanges (MPF) equivalent to IEEE WR sizes.

³ Defined as the maximum VSWR within 20% of the peak VSWR.

⁴ Power rated at maximum VSWR.

⁵ With probes fully retracted.

⁶ At maximum VSWR.



DATA SHEET
4T-050G05

3.5mm & 7mm LXI™-Certified Multi-Harmonic Automated Tuners

0.6 TO 26.5 GHZ



*XT982ML01
LXI™ Automated Tuner
U.S. Patent No. 8,823,392
International Patents Pending*

Specifications

Frequency Range -- See Available Models Table
VSWR Matching Range -- See Available Models Table
Step Size (Probes) -- See footnote¹
Step Size (Carriage) -- See footnote²
Connectors: -- See Available Models Table

Accessories Provided

Each tuner is provided with one (1) MT1020F power supply, one (1) USB cable, one (1) Ethernet cable, one (1) USB to Ethernet adapter, and one (1) operating manual.

Recommended Accessories

8799A1 or 2698C2 Torque Wrench
A028D 7mm Connector Gage Kit
A050A 2.92mm/3.5mm Digital Connector Gage Kit

Available Models

| Model | Frequency Range (GHz) ³ | Matching Range | | | | | | Power Capability ⁴ | Vector Repeatability (Min) | Insertion Loss ⁵ (Max) | Connectors ⁶ |
|-----------|------------------------------------|-----------------------------------|------|----------------------|------------|------------------------|--------|-------------------------------|----------------------------|-----------------------------------|-------------------------|
| | | Single Frequency Tuning (Minimum) | | Two Frequency Tuning | | Three Frequency Tuning | | | | | |
| | | Fmin | Fmax | Fmin | Fmax | Fmin | Fmax | | | | |
| XT981ML01 | 0.65 – 8.0 | 100:1 | 40:1 | 10:1–100:1 | 10:1–100:1 | N/A | | 250 W CW 2.5 kW PEP | –50 dB | 0.3 dB | 7mm |
| XT982ML01 | 0.6 – 18.0 | | | | | 50 W CW 0.5 kW PEP | –40 dB | 1.0 dB | | | |
| XT982ML03 | 0.8 – 18.0 | | | | | 10:1–100:1 | | | 10:1–100:1 | 25 W CW 250 W PEP | |
| XT983ML01 | 2.0 – 26.5 | | | | | N/A | | | | | |

¹ Based on microstepping (1/16) the drive motors
XT981ML01 -- 7.8 microinches
XT982ML01 -- 7.8 microinches
XT983ML01 -- 7.8 microinches

² Based on microstepping (1/16) the drive motors
XT981ML01 -- 234.4 microinches
XT982ML01 -- 62.5 microinches
XT983ML01 -- 62.5 microinches

³ Including fundamental and harmonic frequencies.
⁴ Power rated at maximum VSWR.
⁵ With probes fully retracted.
⁶ Precision 7mm per Maury data sheet 5E-060;
Precision 3.5mm per Maury data sheet 5E-062.



DATA SHEET
4T-050G09

Specifications

Frequency Range -- See Available Models Table
 VSWR Matching Range -- See Available Models Table
 Step Size (Carriage)¹ -- See Available Models Table
 Connectors: -- Precision 7mm²

Accessories Provided

One (1) operating manual.

Recommended Accessories

MT1020C -- USB controller power hub
 2698C2 -- 3/4-in. hex torque wrench
 A028D -- 7mm connector gage kit
 MT999C11 -- Single 1m Cable
 MT999C12 -- Single 2m Cable
 MT999C13 -- Dual 1m Cable

Available Models

| Model | Frequency Range (GHz) | Matching Range | | Power Capability | Vector Repeatability (Minimum) | Step Size (Microinches) ¹ | Phase Change Per Step |
|--------|-----------------------|----------------|---------|----------------------|--------------------------------|--------------------------------------|-----------------------|
| | | Minimum | Typical | | | | |
| MT999A | 0.8 – 7.5 | 50:1 | 65:1 | 10 W CW 100 W PEP | -40 dB | 625 | 0.29° @ 7.5 GHz |
| MT999B | 3.0 – 18.0 | | | | | 2075 | 0.23° @ 18 GHz |
| MT999D | 0.4 – 4.0 | | | | -35 dB | 625 | 0.15° @ 4 GHz |

¹ Based on 1/2-stepping the drive motors.

² Precision 7mm per Maury data sheet 5E-060.

Wide Matching Range Slide Screw Tuners

SERIES MST981, MST982, MST983 & MST984

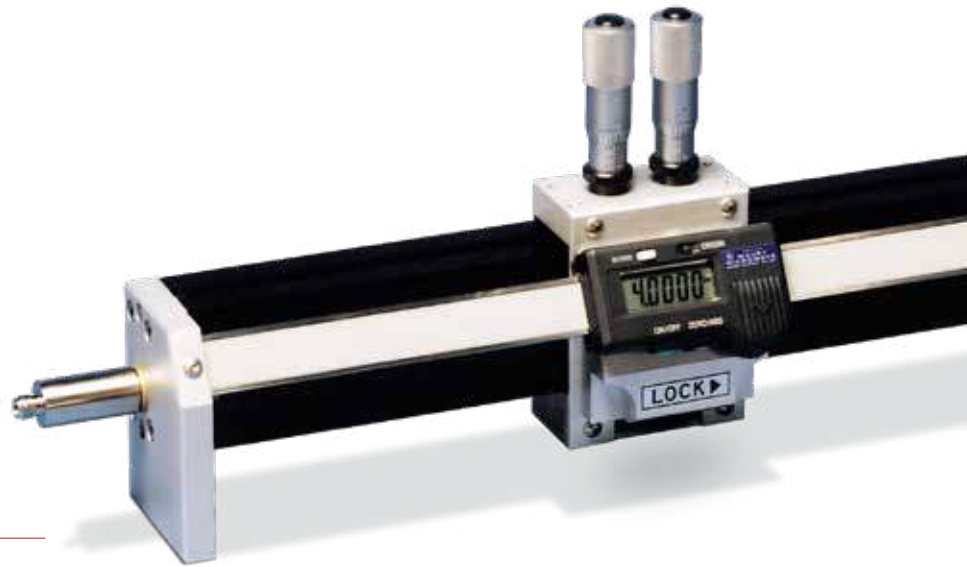

MST982E35

Features

- > Slab-line Transmission Structure
- > Dual Probes for Improved Matching Characteristics
- > LCD Readout for Carriage Position

General Information

Maury manual tuners are based on precision slide screw technology that utilizes broadband slab line transmission structure and passive probes to create impedances for devices. The probes are designed to be very close to one-quarter wavelength in the linear dimension at the mid-band of each range. Since each tuner has two probes, this results in improved matching characteristics for each unit. Another key feature of this series of tuners is the inclusion of a LCD position readout of the carriage position on those units operating below 18 GHz. Higher frequency tuners utilize a micrometer carriage drive.

The positional repeatability and high matching range of these tuners make them ideally suited for use as a variable impedance source in applications like device characterization. Such measurements depend upon the ability of the tuner to establish impedances out near the edge of the Smith Chart and to reproduce the electrical characteristics as a function of mechanical position. The tuners in this series are also easy to use due to the nearly independent electrical results of the mechanical motions. The depth of penetration of the probe into the transmission line determines the magnitude of the reflection, while the position of the probe along the line determines the phase. While there is

some interaction, the effects are almost independent of each other.

Functional Description

The dual probe structure in Maury coaxial slide screw tuners is designed so that one probe (low frequency) covers the range from the lowest frequency to the crossover frequency listed in the Available Models table. The second probe (high frequency) covers the range from the crossover frequency to the tuner's maximum rated frequency. The optimum crossover frequency varies from tuner to tuner.

As each micrometer-driven probe is introduced into the slab-line transmission structure it induces a mismatch in its frequency range. The magnitude of this impedance mismatch is determined by the probe position (depth); the closer the probe approaches the center conductor, the greater the magnitude. The phase of the impedance mismatch is determined by the carriage position along the slab-line. The probes operate independently of each other with little or no interaction. Each probe will meet its specifications over its rated frequency range, and typically has considerably higher matching capability in the middle of its band. Figure 1 shows responses that are typical of those seen in a low frequency/high frequency pair of probes.



DATA SHEET
2G-035

Available Models

| Model | Frequency Range (GHz) | Connector Type | VSWR Matching Range | Maximum Loss (Probes Retracted) | Probe Crossover Frequency | Power Handling ¹ (Ave/Peak Watts) | Dimension "A" | |
|-----------------------|-----------------------|---|---------------------|---------------------------------|---------------------------|--|---------------|---------|
| | | | | | | | Inches | (CM) |
| MST981BN MST981B35 | 0.4 – 4.0 | Type N ⁴ 3.5mm ³ | 25:1 | 0.2 dB | 1.4 GHz | 250/2500 125/1250 | 14.75 | (37.47) |
| MST981EN MST981E35 | 0.8 – 8.0 | Type N ⁴ 3.5mm ³ | 35:1 | 0.2 dB | 2.8 GHz | 250/2500 125/1250 | 7.37 | (18.72) |
| MST982VN MST982V35 | 0.6 – 8.0 | Type N ⁴ 3.5mm ³ | 20:1 | 0.5 dB | 2.8 GHz | 50/500 25/250 | 9.83 | (24.97) |
| MST982GN MST982G35 | 0.6 – 18.0 | Type N ⁴ 3.5mm ³ | 10:1 | 0.6 dB | 4.2 GHz | 50/500 25/250 | 9.83 | (24.97) |
| MST982AN MST982A35 | 1.8 – 18.0 | Type N ⁴ 3.5mm ³ | 12:1 | 0.4 dB | 5.5 GHz | 50/500 25/250 | 3.28 | (8.33) |
| MST983B35 | 12.0 – 34.0 | 3.5mm ^{3,5} | 10:1 | 0.7 dB | 16.0 GHz | 15/150 | 0.49 | (1.24) |
| MST984A24 | 12.0 – 50.0 | 2.4mm ^{2,5} | 10:1 | 1.0 dB | 21.5 GHz | 15/150 | 0.49 | (1.24) |

¹ Within rated matching range.

³ Precision 3.5mm per Maury data sheet 5E-062.

⁵ Non LCD readout model, micrometer-driven carriage.

² Precision 2.4mm per Maury data sheet 5E-064.

⁴ Precision type N per Maury data sheet 5E-049.

Typical Responses

Figure 1. Typical responses seen in low frequency and high frequency probes as they are used in Maury coaxial slide screw tuners.

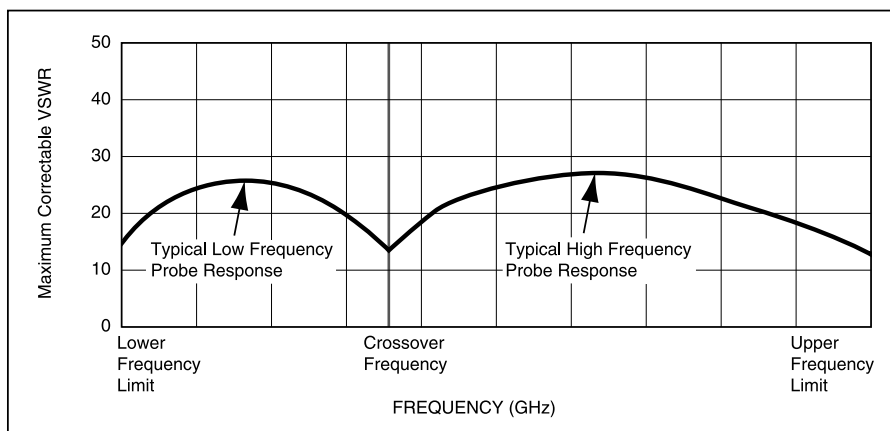

Low-Loss Probe Mounts

SERIES MT902

Features

- > On-Wafer Broadband Pre-Matching
- > Low Loss Wafer Probe Mount
- > 2.0 to 67.0 GHz
- > Ultra-High Stability Design

MT902A2 Pre-Matching Probe Mount on a 50 GHz model MT984AL01, 2.4mm Automated Tuner. This launch configuration is also used on MT902A1 and MT902A3.



General

The MT902 series of pre-matching tuners are highly stable, low loss wafer probe mounts used in on-wafer device characterization applications. By extending a wafer probe away from the tuner body, these mounts create additional clearance for proper probe alignment. The ultra-high stability, inherent in their design, eliminates the possibility of undesired movement during operation.

MT902A5 Basic Probe Mount on a MT984AL01, 50 GHz Automated Tuner. This launch configuration is also used on MT902A6, MT902A7, and MT902D5.

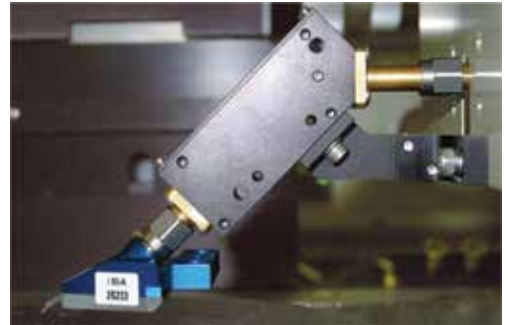

Specifications

Frequency Ranges -- 2.0 to 26.5 GHz & 8.0 to 67.0 GHz

VSWR Range -- 10:1 minimum

Insertion Loss -- 0.30 dB¹/0.30 dB²/0.36 dB³/0.45 dB⁴/0.6 dB⁵

Repeatability -- 40 dB minimum

Power Handling -- 10W CW, 0.5 kW peak

Connectors -- 3.5mm⁶/2.4mm⁷/1.85mm⁸

¹ MT902C1/2 at 26.5 GHz with probe retracted.

² MT902C5/6 at 26.5 GHz with probe retracted.

³ MT902A1/2/3 at 50 GHz with probe retracted.

⁴ MT902A5/6/7 at 50 GHz with probe retracted.

⁵ MT902D5 at 67 GHz.

⁶ Precision 3.5mm per Maury data sheet 5E-062.

⁷ Precision 2.4mm per Maury data sheet 5E-064.

⁸ Precision 1.85mm per Maury data sheet 2K-001.

MT902D5 Basic Probe Mount



DATA SHEET
2G-035D

Available Models

| Model | Description | Frequency Range (GHz) | Matching Range | Recommended For Use With Probe Stations |
|---------|---|-----------------------|----------------|---|
| MT902A1 | Basic Probe Mount | DC – 50 | N/A | Cascade M150 MPI TS150-AIT MPI TS200-THZ MPI TS300-AIT |
| MT902A2 | High frequency pre-matching probe mount | 21.5 – 50.0 | 10:1 | |
| MT902A3 | Low frequency pre-matching probe mount | 8.0 – 21.5 | 10:1 | |
| MT902A5 | Basic probe mount | DC – 50 | N/A | Cascade 11K Cascade 12K Cascade S300 MPI TS150-AIT MPI TS200-THZ MPI TS300-AIT |
| MT902A6 | High frequency pre-matching probe mount | 21.5 – 50.0 | 10:1 | |
| MT902A7 | Low frequency pre-matching probe mount | 8.0 – 21.5 | 10:1 | |
| MT902C1 | Basic probe mount | DC – 26.5 | N/A | Cascade M150 MPI TS150-AIT MPI TS200-THZ MPI TS300-AIT |
| MT902C2 | High frequency pre-matching probe mount | 7.3 – 26.5 | 10:1 | |
| MT902C5 | Basic probe mount | DC – 26.5 | N/A | Cascade 11K Cascade 12K Cascade S300 MPI TS150-AIT MPI TS200-THZ MPI TS300-AIT |
| MT902C6 | High frequency pre-matching probe mount | 7.3 – 26.5 | 10:1 | |
| MT902D5 | Basic probe mount | DC – 67 | N/A | Cascade 11/12K Cascade S300 MPI TS150-AIT MPI TS200-THZ MPI TS300-AIT |

Noise Receiver and Noise Switch Modules

SERIES MT7553

Features

- > Instantaneous Ultra-Wideband Measurements from 100 MHz – 65 GHz
- > Banded Measurements from 50–75 GHz, 60–90 GHz, and 75–100 GHz
- > Automates Noise Parameter Measurement Systems
- > Replaces External Banded Components
- > Integrated Downconverter, Bias Tees, Low-Noise Amplifier, and Switches
- > Low Noise Figure for Improved System Calibration Accuracy and Repeatability



MT7553B03



MT7553C01



Noise Parameters System

Introduction

Noise Parameters are the non-50Ω extensions of Noise Figure, and are an important modeling and model validation tool to understand how a device-under-test's performance changes as a function of source impedance. Noise Parameter measurements are typically performed using a Vector Network Analyzer (VNA)

to measure the S-Parameters of the DUT, and a Noise Analyzer (either Noise Figure Analyzer NFA or Spectrum Analyzer SA) to measure the noise power of the DUT, with typical system block diagrams shown in Figures 1 and 2. Noise parameters are calculated from a combination of known source impedances, S-parameters and noise powers.

Figure 1. Block diagram of typical Noise Parameters setup with separate VNA and NFA

Figure 2. Block diagram of typical Noise Parameters setup with combined VNA and NFA

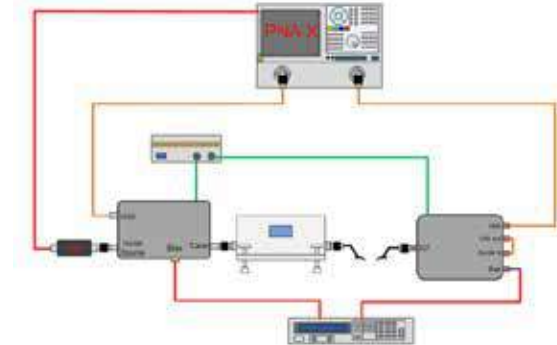
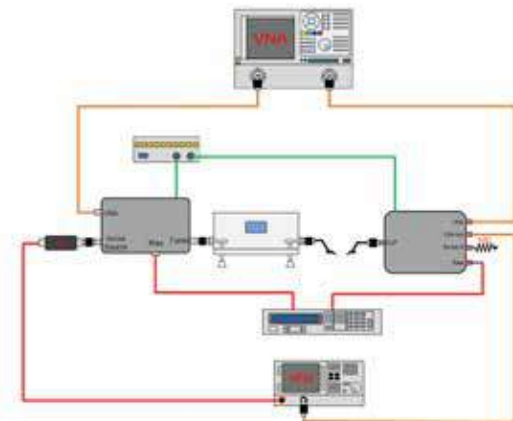

DATA SHEET
4T-085

Noise Receivers and Noise Receiver Calibration

The Noise Receiver consists of the component chain from the DUT output to, and including, the Noise Analyzer. The minimum Noise Figure (Fmin) of the Noise Receiver will affect the minimum accurately measurable Noise Figure of the DUT by increasing the sensitivity of the receiver. Therefore, it is critical to provide a Noise Receiver with the lowest Fmin possible. In addition, Noise Analyzers may not be available at the frequencies of interest and in these cases it is common to use a downconverter chain to lower the frequency of the signal to one that can be measured by the Noise Analyzer. Maury's family of MT7553-series Noise Receiver Modules assist in doing exactly these things. Typical noise receiver calibrations using MT7553-series NRMs are shown in Figures 3-5.

MT7553-series Coaxial Noise Receiver Modules

MT7553-series coaxial Noise Receiver Modules integrate the entire output network of a typical Noise Parameter measurement system into a turnkey solution. These NRMs consist of:

- > Wideband low-noise amplifiers to improve the sensitivity of the Noise Receiver.
- > RF switches to switch between VNA and NFA paths.
- > Wideband bias tees to provide bias to the device under test.

The MT7553A03 NRM covers 0.1-26.5 GHz and is designed to operate with either standalone Noise Analyzer or combined VNA/NFA up to 26.5 GHz.

The MT7553B03 NRM covers 0.1-50 GHz and is designed to operate with either standalone Noise Analyzer or combined VNA/NFA up to 50 GHz.

In cases where the NFA does not match the Noise Parameters frequency of interest, an NRM with integrated downconverter module may be used to accept an input signal (commonly referred to as RF signal) at F1 and mix it with local oscillator signal F2, resulting in an intermediate frequency (IF) of F1-F2, a frequency able to be directly measured by a lower frequency NFA.

The MT7553B01 NRM covers 0.1-50 GHz and is designed to operate with either standalone Noise Analyzer or combined VNA/NFA where the VNA operates to at least 50 GHz, but the NFA operates to 26.5 GHz.

The MT7553C01 NRM covers 0.1-65 GHz and is designed to operate with either standalone Noise Analyzer or combined VNA/NFA where the VNA operates to at least 65 GHz, but the NFA operates to 50 GHz.

MT7553M-series Millimeter Wave Noise Receiver Modules

MT7553M-series waveguide Noise Receiver Modules are designed for full millimeter-wave noise parameter

measurements within the TE10 waveguide band of operation and downconverts noise power densities from the frequency of interest to the NFA bandwidth using a double sideband swept LO technique. Models are available between 50-75 GHz (WR15), 60-90 GHz (WR12) and 75-100 GHz (WR10). Biasing and switching functions are external to the MT7553M-series NRMs.

MT7553N-series Noise Switching Modules

MT7553N-series Noise Switching Modules integrates the entire input network of a typical Noise Parameter measurement system into a turnkey solution. These NSMs consist of

- > RF switches to switch between the VNA and noise source paths
- > Wideband bias tees to provide bias to the device under test

The MT7553N26, MT7553N50 and MT7553N65 cover 0.1-26.5 GHz, 0.1-50.0 and 0.1-65.0 GHz respectively.

Available Noise Receiver Modules

| Model | System Input Frequency (GHz) | NFA Output Frequency (GHz) | LO | Mixer | LNA | Bias Tee | RF Switch | VNA/NFA Ports | Noise Figure | | Connector |
|-----------|------------------------------|----------------------------|----------|----------|----------|----------|-----------|--------------------|--------------|------|---------------|
| | | | | | | | | | Typ | Max | |
| MT7553A03 | 0.1 – 26.5 | 0.1 – 26.5 | N/A | | Internal | Internal | Internal | Separate/ Combined | 6 | 8 | 3.5mm female |
| MT7553B01 | 0.1 – 50.0 | | Internal | | | | | | 15 | 20 | |
| MT7553B03 | | | N/A | | | | | | 10 | 16 | 1.85mm female |
| MT7553C01 | 0.1 – 65.0 | 0.1 – 50.0 | External | Internal | Internal | External | Separate | 12 | | WR15 | |
| MT7553M15 | 50.0 – 75.0 | | | | | | | | | WR12 | |
| MT7553M12 | 60.0 – 90.0 | | | | | | | | | WR10 | |
| MT7553M10 | 75.0 – 110.0 | | | | | | | | | | |

Available Noise Switching Modules

| Model | Frequency (GHz) | Bias Tee | RF Switch | Connector |
|-----------|-----------------|----------|-----------|---------------|
| MT7553N26 | 0.1 – 26.5 | Internal | Internal | 3.5mm female |
| MT7553N50 | 0.1 – 50.0 | | | 2.4mm female |
| MT7553N65 | 0.1 – 65.0 | | | 1.85mm female |

Maury Microwave MT981BL18 and MT983AL01 automated impedance tuners were used to cover the frequency range.

Maury Microwave MT7553A03 (direct frequency to 26.5 GHz) and MT7553N26 NRM and NSM modules were used as the input and output noise modules.

Keysight N5247A PNA-X with option 029 was used as the VNA and NFA. Noisewave NW346V was used as the noise source.

Maury Microwave ATS software was used to perform measurements with the following settings: fast noise with 22 source impedance points, noise averaging of 16, noise receiver gain set to high gain, noise calculation using cold only formulation.

Fmin reported at the NRM connector reference plane.

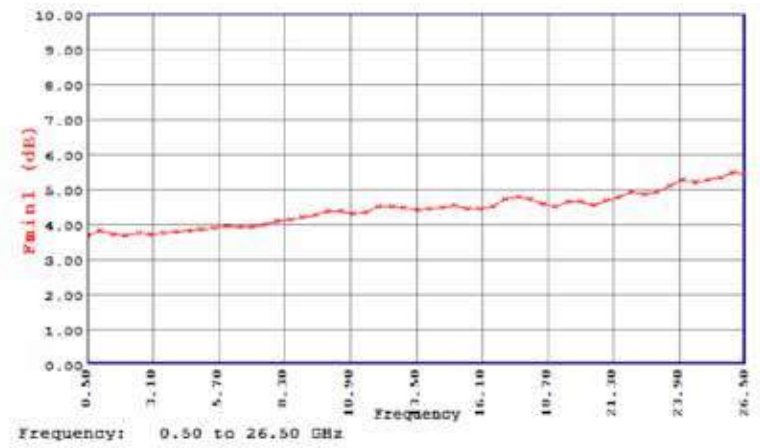

Figure 3. Typical Noise Receiver Calibration Using MT7553A03

Maury Microwave MT981BL18 and MT985AL01 automated impedance tuners were used to cover the frequency range.

Maury Microwave MT7553B03 (direct frequency to 50 GHz) and MT7553N50 NRM and NSM modules were used as the input and output noise modules.

Keysight N5247A PNA-X with option 029 was used as the VNA and NFA. Noisewave NW346V was used as the noise source.

Maury Microwave ATS software was used to perform measurements with the following settings: fast noise with 22 source impedance points, noise averaging of 16, noise receiver gain set to high gain, noise calculation using cold only formulation.

Fmin reported at the NRM connector reference plane.

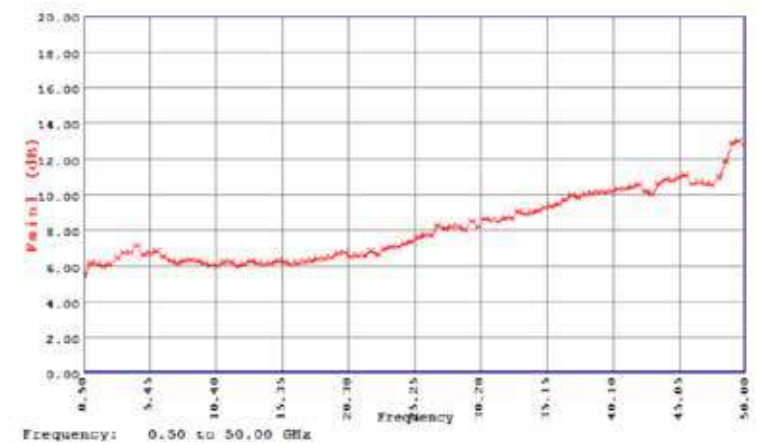

Figure 4. Typical Noise Receiver Calibration Using MT7553B03

Maury Microwave MT981BL18 and MT983AL01 automated impedance tuners were used to cover the frequency range.

Maury Microwave MT7553C01 (direct frequency to 50 GHz, downconverted frequencies between 50-65 GHz) and MT7553N65 NRM and NSM modules were used as the input and output noise modules.

Keysight N5247A PNA-X with option 029 was used as the VNA and NFA. Noisewave NW346V was used as the noise source.

Maury Microwave ATS software was used to perform measurements with the following settings: fast noise with 22 source impedance points, noise averaging of 16, noise receiver gain set to high gain, noise calculation using cold only formulation.

Fmin reported at the NRM connector reference plane.

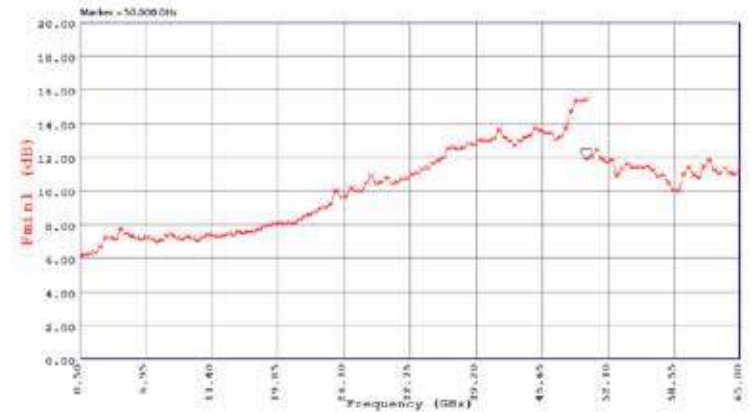

Figure 5. Typical Noise Receiver Calibration Using MT7553C01

Low-Loss Couplers

LOW-LOSS, HIGH DIRECTIVITY, HIGH POWER COUPLERS FOR LOAD PULL AND OTHER POWER APPLICATIONS

Features

- > High Power Handling
- > High Directivity
- > Low Insertion Loss
- > Broadband Performance
- > Excellent VSWR

Applications

- > Amplifier Power Monitoring
- > High-Power Base Station Integration
- > Test and Measurement (Load Pull, Antenna Test, General Lab...)

Description

The LLC-series of bidirectional airline couplers represents a breakthrough in high-power coupler technology. Combining precision machining with stellar electrical characteristics, LLC-series couplers offer unmatched performance. The differentiating features of the LLC-series bidirectional coupler include high power handling, high directivity, low insertion loss and broadband performance. High power handling enables integration in high-power applications including amplifiers and base stations, and for high-power test and measurement applications including PA testing and load pull. Unlike inferior models which are rated at breakdown, Maury defines power handling capability as the power at which there is no discernible change in the performance of the coupler.

High directivity, the difference between coupling and isolation, enables highly-accurate measurements by isolating the direct and coupled measurement pathways. This is especially important in a calibrated system where changing coupler characteristics due to poor directivity can invalidate the calibration and result in erroneous measurements. Low insertion loss is critical for high-power applications in order to avoid power loss and eliminate drift due to heating. Compared with microstrip couplers that suffer losses and self-heating due to metal resistivity and dielectric permittivity, LLC-series airline couplers have no added dielectric. When used as part of a vector-receiver load pull setup, low insertion loss directly maximizes tuning range when combined with an impedance tuner. The broadband nature of the coupler allows it to be used for wideband applications.



LLC18-7
Low-Loss
Coupler



LLC18-N-MF
Low-Loss
Coupler



LLC34-35-MF
Low-Loss
Coupler



LLC67-185-MM
Low-Loss
Coupler

Specifications

| Available Models | Connector | | Coupling Ports | Frequency Range ¹ (GHz) | Max Insertion Loss at Fmax | Directivity Typ. | Coupling Typ. | Power Handling |
|------------------|---------------|---------------|----------------|------------------------------------|----------------------------|------------------|-----------------------------|----------------------|
| | Input Port | Output Port | | | | | | |
| LLC18-7 | 7mm | 7mm | 3.5mm Female | 0.6 – 8.0 | 0.15 dB | 15 dB | 30 dB ² ±3 dB | 500 W CW / 2 KW Peak |
| LLC18-N-FF | Type N Female | Type N Female | | | 0.25 dB | | | |
| LLC18-N-MF | Type N Male | Type N Female | | 0.35 dB | | | | |
| LLC18-N-MM | Type N Male | Type N Male | | | | | | |
| LLC34-35-FF | 3.5mm Female | 3.5mm Female | 2.92mm Female | 2.0 – 26.5 | 0.35 dB | 14 dB | | |
| LLC34-35-MF | 3.5mm Male | 3.5mm Female | | | | | | |
| LLC34-35-MM | 3.5mm Male | 3.5mm Male | | | | | | |
| LLC67-185-FF | 1.85mm Female | 1.85mm Female | 1.85mm Female | 3.0-20.0 | | | | |
| LLC67-185-MF | 1.85mm Male | 1.85mm Female | | | 0.4 dB | | | |
| LLC67-185-MM | 1.85mm Male | 1.85mm Male | | 20.0-67.0 | | | | |



DATA SHEET
2K-001

¹ Usable from 0.1 GHz with increased coupling.
² ±6dB 0.6 – 0.8 GHz for LLC18 and 2.0 – 3.0 GHz for LLC34.

³ ±10 dB 3.0 – 6.0 GHz.

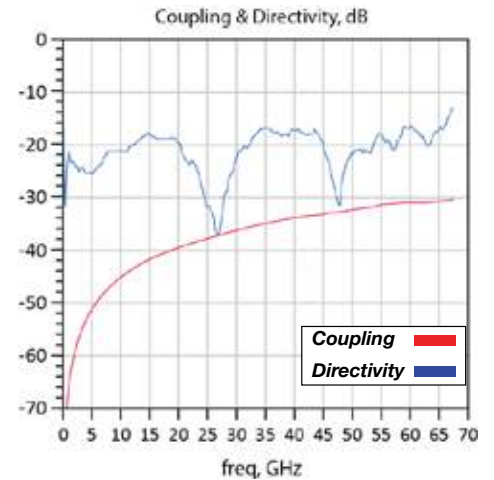
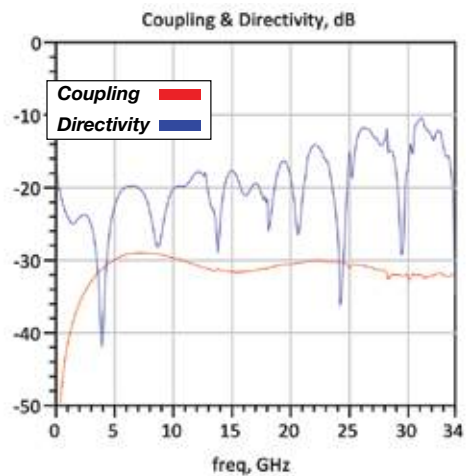
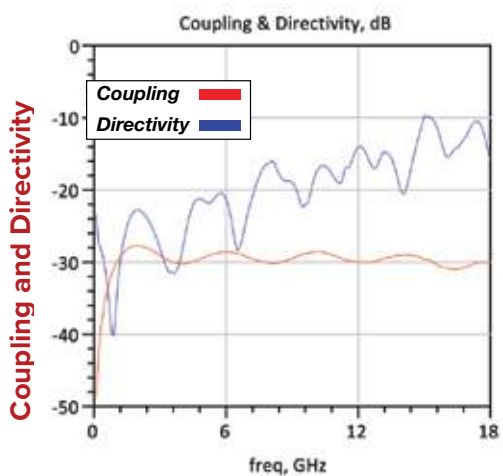
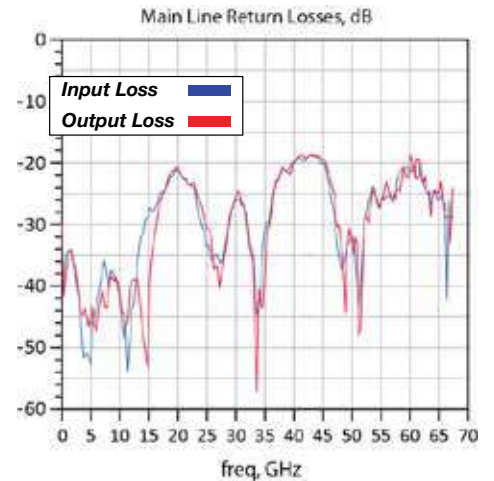
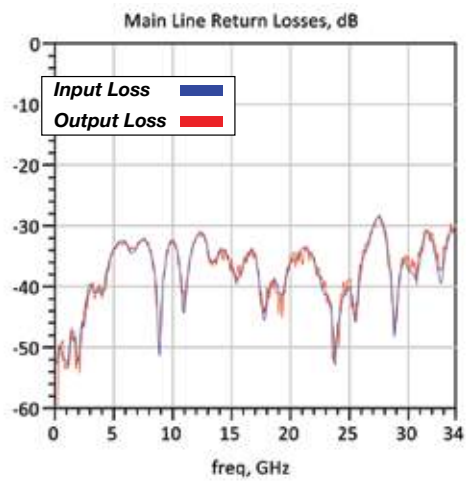
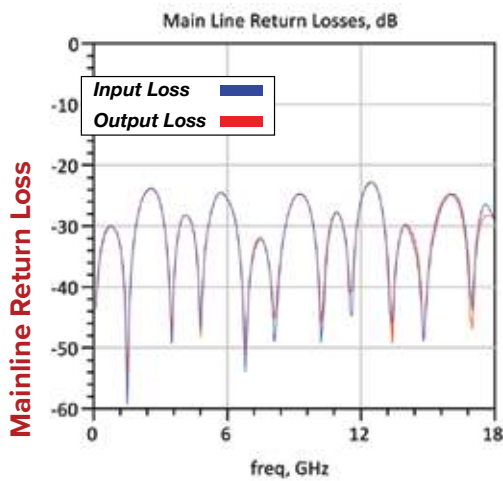
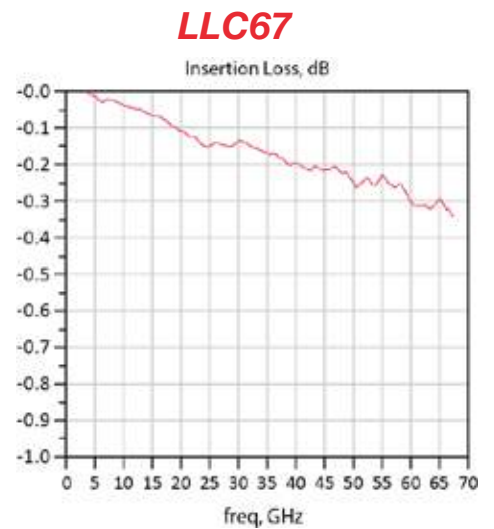
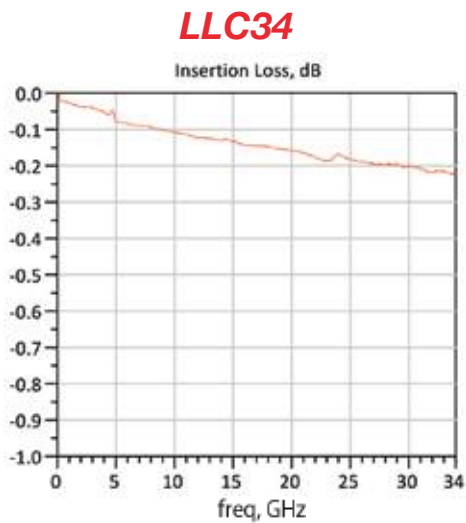
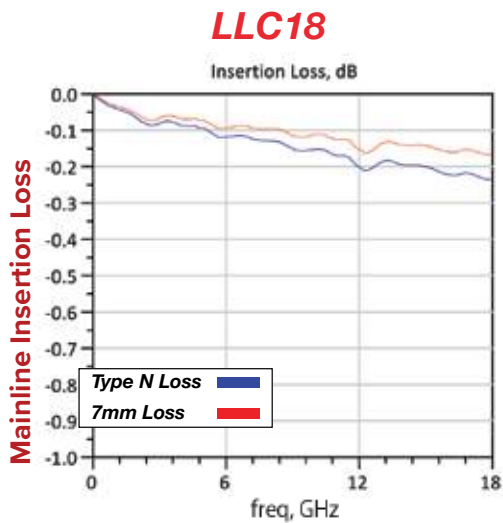

Low-Loss Couplers with Integrated Downconverters

LOW-LOSS, HIGH DIRECTIVITY, HIGH POWER COUPLERS FOR LOAD PULL AND OTHER POWER APPLICATIONS

Features

- > High Power Handling
- > High Directivity
- > Low Insertion Loss
- > Full Waveguide Band
- > Excellent VSWR
- > Integrated Downconverter

Description

The LLC-series of bidirectional waveguide couplers with integrated downconverters are ideal for waveguide banded mmW load pull applications. The coupler's low insertion-loss and high-directivity ensures a minimal impact on the tuning range at the DUT reference plane, while enabling the benefits of vector-receiver load pull measurements. The integrated downconverters allow a direct connection to a sub-26.5 GHz VNA's receiver ports without worrying about mechanical incompatibilities of standard waveguide frequency extender modules.

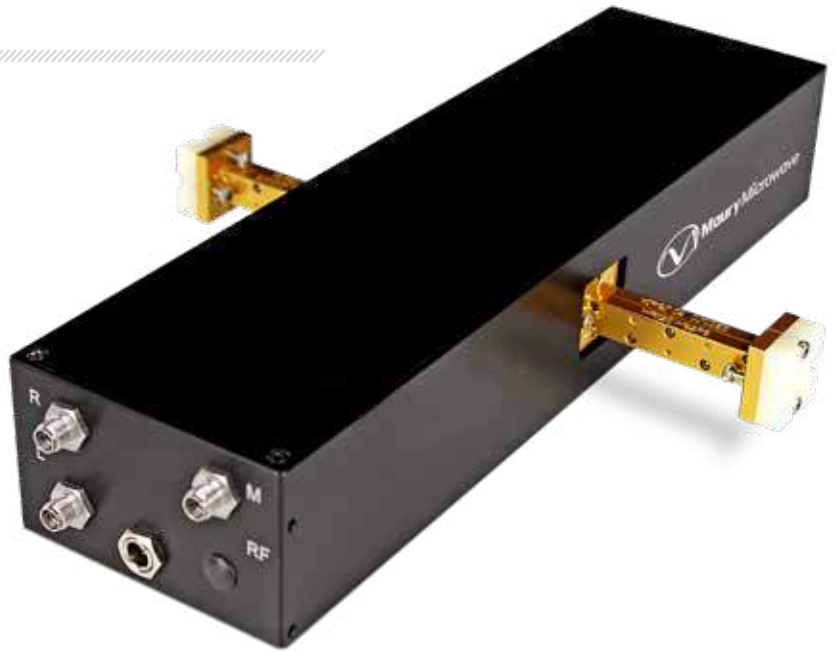

Specifications

| Available Models | Connector | | Coupling Ports | Frequency Range ¹ (GHz) | Typ. Insertion Loss at Fmax | Directivity Typ. | Coupling Typ. | Power Handling |
|------------------|------------|-------------|--------------------|------------------------------------|-----------------------------|------------------|-----------------|----------------|
| | Input Port | Output Port | | | | | | |
| LLC75WR15 | WR15 | WR15 | 3.5mm ⁴ | 50-75 | 0.8dB | 30dB | 36 ⁵ | 5W |
| LLC90WR12 | WR12 | WR12 | 3.5mm ⁴ | 60-90 | 0.8dB | 30dB | 43 ⁵ | 5W |
| LLC110WR10 | WR10 | WR10 | 3.5mm ⁴ | 75-110 | 0.8dB | 30dB | 42 ⁵ | 2W |

⁴ X6 down conversion included, it requires external LO (max 2dBm).

⁵ A micrometer is included to reduce the coupling factor of 30dB.



DATA SHEET
2K-001

High-Power Low-Loss Pulsed Bias Tees

Features

- > High RF Power Handling
- > High Breakdown Voltage
- > High Current Handling
- > Low Insertion Loss
- > Excellent Return Loss
- > Pulsing Capable

Applications

- > High-Power System Biasing
- > High-Power Base Station Integration
- > Test and Measurement (Load Pull, Pulsed Measurements, General Lab...)



Model:
MBT18-7-1000
U.S. Patent No. 9,614,267

Description

Bias tees are passive RF circuits which provide DC bias to an active device under test. Normally consisting of a capacitor and inductor, bias tees act as diplexers by combining low-frequency (DC) and high frequency (RF) signals onto a common port (RF+DC). In a classic capacitor/inductor design, the capacitor acts as a DC block and prevents DC bias from entering the RF path, while the inductor acts as an RF choke preventing RF energy from entering the DC instrumentation.

Typical applications include providing bias to amplifiers inside of complex systems including base stations and radios; and biasing discrete transistors or packaged devices in test and measurement applications such as DC/pulsed-bias S-parameters, DC/pulsed-IV, DC/pulsed-bias load pull, stability-, robustness-, burn-in-, pre-production- and production-test.

Important characteristics of a bias tee include the frequency range over which the bias tee will function with minimal to no performance degradation, the insertion loss and VSWR (or return loss) over the usable frequency range of the bias tee. Voltages, currents and RF powers are critical both in average/DC/CW and pulsed/peak operations. It is also essential to have bias tees with minimal overshoot of the signals under pulsed bias/pulsed RF conditions.

Specifications

| Model | Connector | | | Frequency Range (GHz) | Insertion Loss (dB) | | Return Loss (dB) Typical | Max Voltage (V) | Max DC Current (A) | RF Rating | | | | Isolation (dB) Typical | DC Resistance (ohm) Typical | DC BW (MHz) Typical |
|----------------|-----------------|-----------------|------------|-----------------------|---------------------|-----|--------------------------|-----------------|--------------------|----------------|--------------|-------------------------------|-----------------------------|------------------------|-----------------------------|---------------------|
| | RF Port | RF+DC Port | DC Port | | Typ | Max | | | | CW Current (A) | CW Power (W) | Peak Current (A) ¹ | Peak Power (W) ¹ | | | |
| MBT18-7-1000 | 7mm | | SMA Female | 0.35 - 18 | 0.28 | 0.6 | 22 | 100 | 1 | 1 | 10 | 2 | 40 | 34 | 0.4 | 10 |
| MBT18-7-5000 | 7mm | | SMA Female | 6 - 18 | 1.1 | 1.5 | 15 | 100 | 5 | 5 | 50 | 15 | 250 | 30 | 0.4 | 10 |
| MBT18-NMF-5000 | Type N (male) | Type N (female) | SMA Female | 6 - 18 | 1.1 | 1.5 | 15 | 100 | 5 | 5 | 50 | 15 | 250 | 30 | 0.4 | 10 |
| MBT18-NFM-5000 | Type N (female) | Type N (male) | SMA Female | 6 - 18 | 1.1 | 1.5 | 15 | 100 | 5 | 5 | 50 | 15 | 250 | 30 | 0.4 | 10 |

¹ Power and current rating valid under the following condition: $T_{on} = 100\mu s$, Duty Cycle = 10%, $I_q \leq 500mA$. Different pulse conditions will affect the peak power and current handling.



DATA SHEET
2K-002

MBT18-7-1000
Typical Insertion
Loss - dB

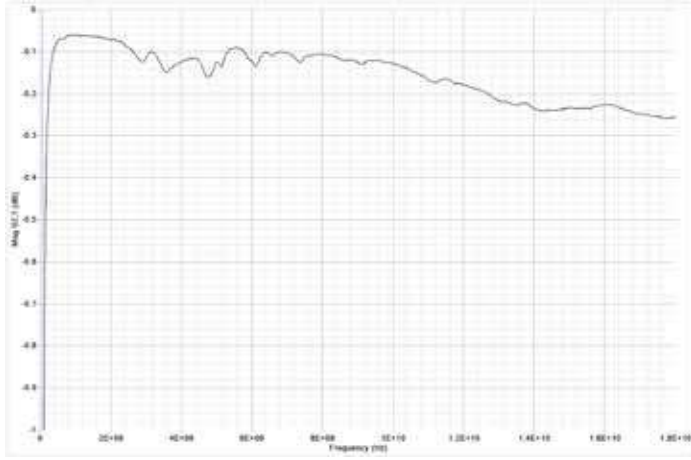

MBT18-7-1000
Typical Return
Loss - dB

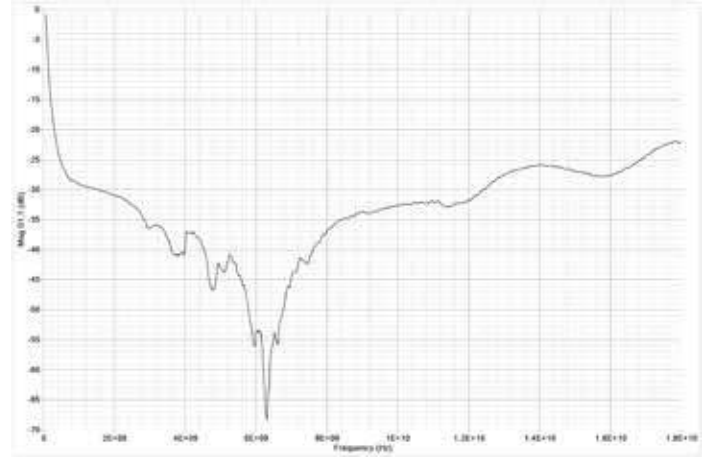

MBT18-7-5000
Typical Insertion
Loss - dB

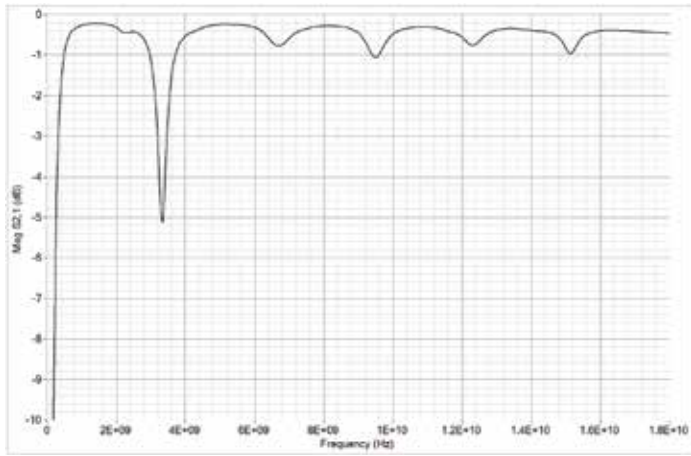

MBT18-7-5000
Typical Return
Loss - dB

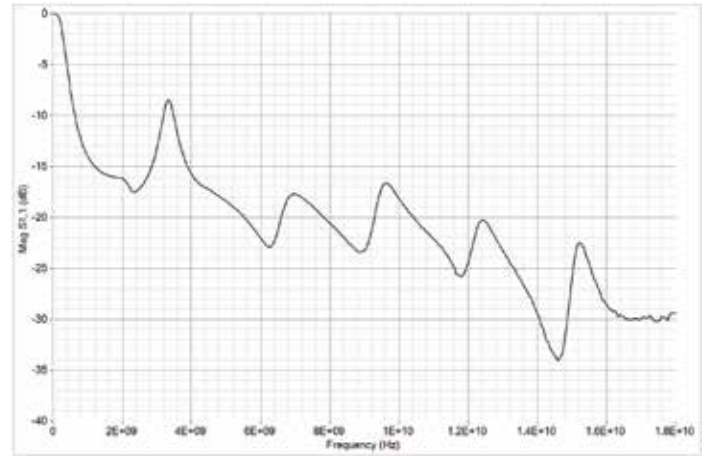

Typical Applications

Load pull

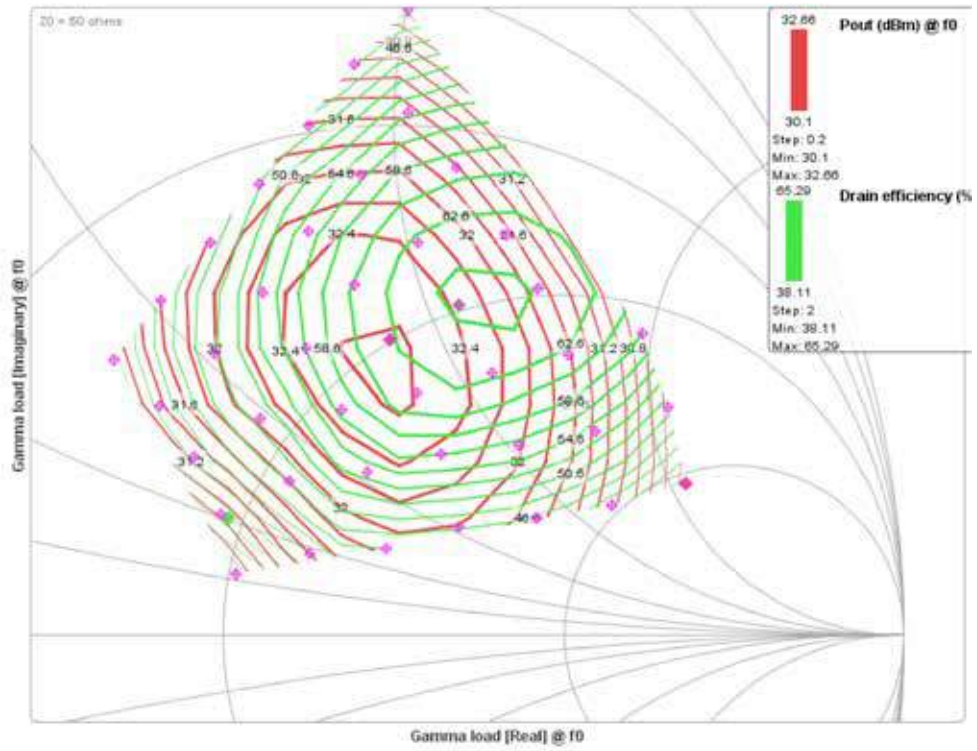

Pulsed IV down to 1us

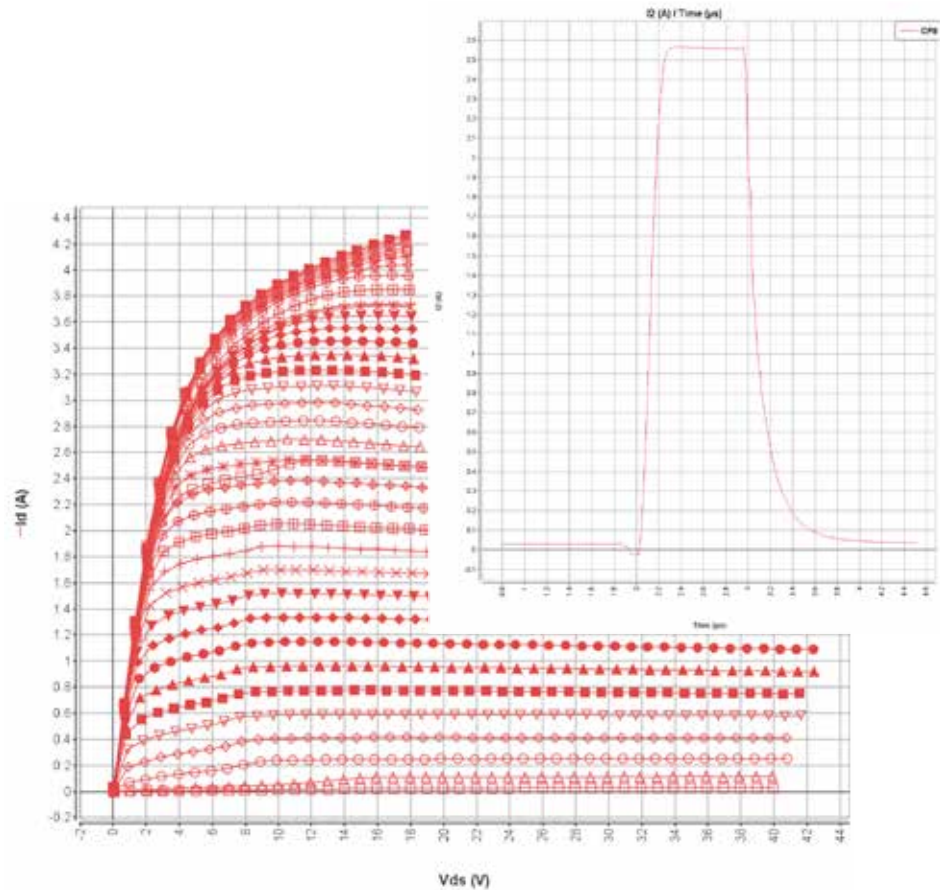

Low-Loss Coaxial Multiplexers



What Are Multiplexers?

With regards to microwave and RF networks, multiplexers are multi-port frequency-selective combiners/splitters built from a series of filters to combine/split carrier signals at multiple frequencies while providing a high degree of isolation between ports.

Multiplexers are an effective solution for combining signals at different frequencies onto a common transmission line without the resistive losses found in traditional wideband combiners/splitters. Multiplexers can be created from a number of different filters, including low-pass, bandpass and high-pass, depending on the nature of the multiplexer.

Diplexers are typically created from low-pass and high-pass filters, whereas triplexers often have low-pass, bandpass and high-pass networks. Some multiplexers allow the passing of DC bias between the low-band and common ports, while others using only bandpass filters may block bias. Insertion loss between the frequency-selective and common ports may vary depending on the technology used to build multiplexers, as does power handling capability.

DP-Series and TP-Series Overview

Maury's line of diplexers (DP-series) and triplexers (TP-series) are designed for applications which require combining/splitting signals at or around harmonic frequencies (nF_0) and are connectorized for design-in and test and measurement applications.

DP-series diplexers are designed using low-pass and high-pass filters and pass bias between the low-frequency (or F_0) port and the common (or DUT) port. TP-series triplexers are designed using low-pass, bandpass and high-pass filters and pass bias between the low-frequency (or F_0) port and the common (or DUT) port.

Typical S-parameter data can be downloaded at maurymw.com.



DATA SHEET
4T-012

Available Models (DP Series Diplexers)

| Model | Frequency Range (GHz) | | Typical Insertion Loss @ Fmin (dB) | | Typical Insertion Loss @ Fmax (dB) | | Power Rating In Fundamental Band | Connectors | | |
|----------|-----------------------|--------------|------------------------------------|-----|------------------------------------|-----|----------------------------------|---------------|-----------|------------|
| | Fo | 2Fo | Fo | 2Fo | Fo | 2Fo | | Fo Input | Fo Output | 2Fo Output |
| DP-06810 | 0.68 - 1.0 | 1.36 - 2.0 | 0.5 | 1.1 | 0.6 | 0.6 | 100 W CW | SMA female | | |
| DP-1220 | 1.20 - 2.0 | 2.40 - 4.0 | 0.4 | 1.5 | 0.7 | 0.9 | 100 W CW | SMA female | | |
| DP-1823 | 1.80 - 2.30 | 3.60 - 4.60 | 0.4 | 1.3 | 0.6 | 1.1 | 100 W CW | SMA female | | |
| DP-2232 | 2.20 - 3.20 | 4.40 - 6.40 | 0.4 | 1.4 | 0.8 | 0.7 | 100 W CW | SMA female | | |
| DP-2942 | 2.90 - 4.20 | 5.80 - 8.40 | 0.8 | 1.4 | 0.9 | 1.5 | 100 W CW | SMA female | | |
| DP-3957 | 3.90 - 5.70 | 7.80 - 11.40 | 0.4 | 1.4 | 0.7 | 1.3 | 100 W CW | SMA female | | |
| DP-5070 | 5.0 - 7.0 | 10.0 - 14.0 | 0.5 | 1.0 | 0.5 | 1.3 | 50 W CW | 2.92mm female | | |
| DP-7090 | 7.0 - 9.0 | 14.0 - 18.0 | 0.5 | 1.0 | 0.5 | 1.3 | 50 W CW | 2.92mm female | | |
| DP-8010 | 8.0 - 10.0 | 16.0 - 20.0 | 0.6 | 1.0 | 0.6 | 1.3 | 40 W CW | 2.92mm female | | |

Available Models (TP Series Triplexers)

| Model | Frequency Range (GHz) | | | Typical Insertion Loss @ Fmin (dB) | | | Typical Insertion Loss @ Fmax (dB) | | | Power Rating In Fundamental Band | Connectors | | | |
|----------|-----------------------|-------------|-------------|------------------------------------|-----|-----|------------------------------------|-----|-----|----------------------------------|---------------|-----------|------------|------------|
| | Fo | 2Fo | 3Fo | Fo | 2Fo | 3Fo | Fo | 2Fo | 3Fo | | Fo Input | Fo Output | 2Fo Output | 3Fo Output |
| TP-08710 | 0.87 - 1.0 | 1.74 - 2.0 | 2.61 - 3.00 | 0.8 | 1.1 | 1.4 | 0.8 | 0.8 | 1.2 | 100 W CW | SMA female | | | |
| TP-1822 | 1.80 - 2.20 | 3.60 - 4.40 | 5.40 - 6.60 | 0.4 | 1.4 | 1.5 | 0.5 | 1.8 | 1.3 | 100 W CW | SMA female | | | |
| TP-2226 | 2.20 - 2.65 | 4.40 - 5.30 | 6.60 - 7.95 | 0.3 | 1.7 | 1.8 | 0.4 | 1.7 | 1.4 | 100 W CW | SMA female | | | |
| TP-2631 | 2.60 - 3.10 | 5.20 - 6.20 | 7.80 - 9.30 | 0.8 | 1.3 | 1.9 | 0.9 | 1.8 | 1.9 | 100 W CW | SMA female | | | |
| TP-3040 | 3.0 - 4.0 | 6.0 - 8.0 | 9.0 - 12.0 | 0.5 | 1.0 | 1.0 | 0.6 | 1.3 | 1.3 | 50 W CW | 2.92mm female | | | |
| TP-4050 | 4.0 - 5.0 | 8.0 - 10.0 | 12.0 - 15.0 | 0.5 | 1.0 | 1.0 | 0.6 | 1.3 | 1.3 | 50 W CW | 2.92mm female | | | |
| TP-5060 | 5.0 - 6.0 | 10.0 - 12.0 | 15.0 - 18.0 | 0.5 | 1.0 | 1.0 | 0.8 | 1.3 | 1.3 | 20 W CW | 2.92mm female | | | |

MT964 Load Pull Test Fixtures

LOW-LOSS TEST FIXTURES FOR LOAD PULL AND OTHER POWER APPLICATIONS

Features

- > Low Insertion Loss for High VSWR Tuning
- > Multiple Connector Configurations
- > 50Ω and Transformers Available
- > Heatsinks and Fans Available
- > Water Cooling Available
- > Integrated Biasing Available

Accessories Provided

- > TRL Calibration Kit ¹

Optional Accessories

- > Water Cooling
- > Device Inserts



MT964A1-50
7mm Load Pull
Test Fixture



Available Models

| Available Models | Frequency Range (GHz) | Impedance | Connector | Fixture Size | Bias | Power Handling ² |
|------------------|-----------------------|-----------|-----------|--------------|-----------------------|-----------------------------|
| MT964A1-50 | 0.1 – 15.0 | 50 Ω | 7mm | 950 mil | No | 250 W CW |
| MT964A2-50 | | | 3.5mm | | | 25 W CW |
| MT964A3-50 | | | 2.4mm | | | 25 W CW |
| MT964C1-50 | 0.8 – 15.0 | 50 Ω | 7mm | 2500 mil | Optional ³ | 250 W CW |
| MT964C2-50 | | | 3.5mm | | | 25 W CW |
| MT964C3-50 | | | 2.4mm | | | 25 W CW |
| MT964C1-10 | | 10 Ω | 7mm | | | 250 W CW |
| MT964C2-10 | | | 3.5mm | | | 25 W CW |
| MT964C3-10 | | | 2.4mm | | | 25 W CW |

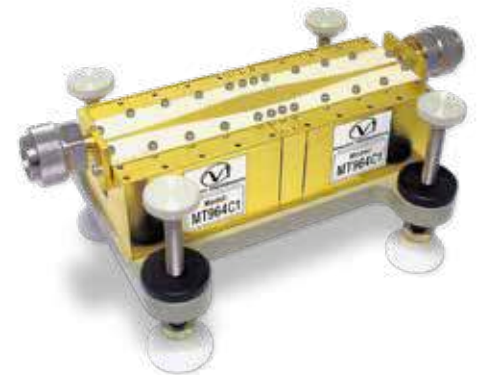

MT964C1-10
7mm Load Pull
Test Fixture

¹ Thru and Reflect standards built into fixture, external Line standard provided.

² Proper heat dissipation of DUT is required.

³ Contact our Sales Staff for biasing option.



DATA SHEET
4T-005

Typical S21
Performance of
MT964A1-50

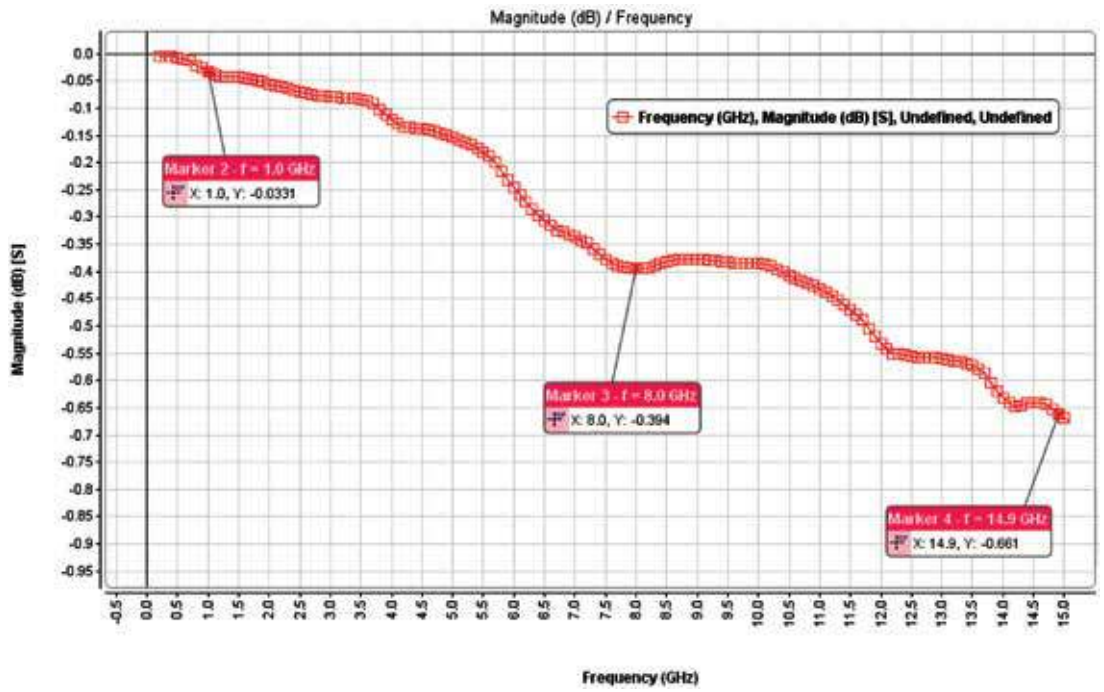

Typical S11
Performance of
MT964C1-10

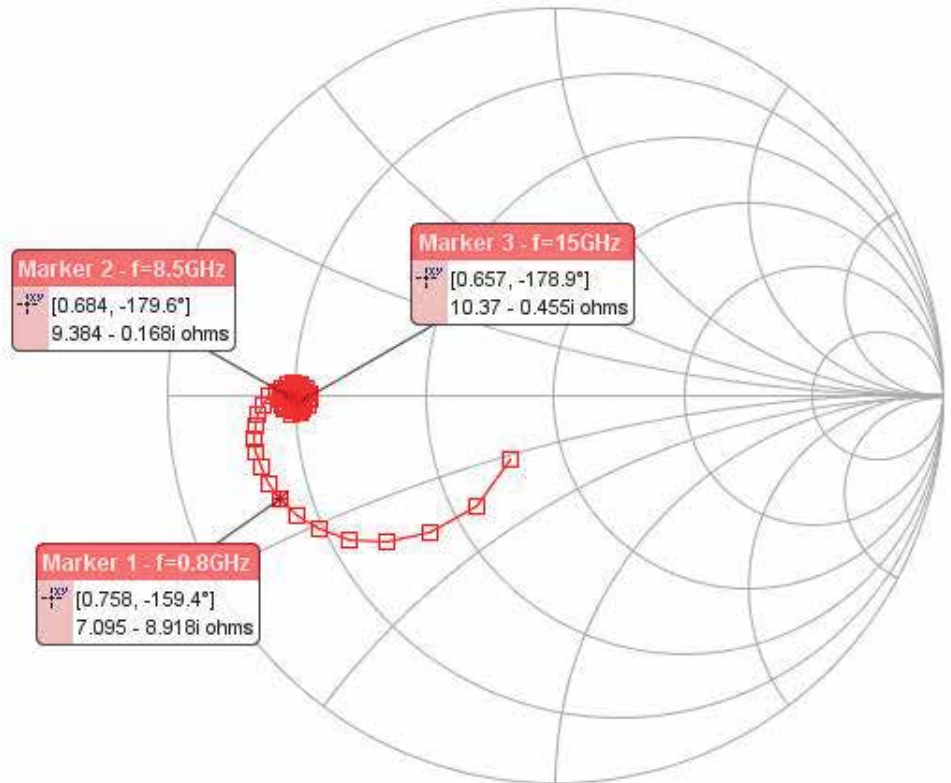

Anteverta High-Precision Current Probes

GENERAL INFORMATION



Features & Benefits

- > Resistor-based for simplified long-term use
- > Ideal for low-current measurements
- > Compatible with most commercial oscilloscopes and digitizers
- > Ideal for pulsed measurements

What are Current Probes?

Current probes are active devices which are used in conjunction with an oscilloscope or DMM to determine the current of a device under test. Current probes are either placed directly between a measurement instrument and DUT in order to measure the amplified voltage across an internal resistance or clamped onto a conductor/wire in order to measure the magnetic field created by the current flowing through the wire.

AVCP-Series Overview

AVCP-series current probes are based on a series resistor and differential amplifier which generates an output voltage proportional to the current flowing through the resistor. Large series resistors are used to create a large voltage drop in order to measure extremely low currents in the order of μA and mA . Unlike current probes based on Hall effect sensors, AVCP-series current probes do not need to be demagnetized (degaussed) and can be used more easily over long periods of time. AVCP current probes can be connected by BNC cable to nearly any commercial oscilloscope or DMM and are ideal for measuring active devices with low currents such as transistors under pulsed conditions.

Available Models

| | AVCP-1 | AVCP-10 | AVCP-50 |
|--|---|---|--|
| Irange (DC continuous) | +/- 0.2 A | +/- 0.02 A | +/- 0.004 A |
| Vrange | -5 V to 80 V | -5 V to 80 V | -5 V to 80 V |
| Gain | 10 V/A | 100 V/A | 500 V/A |
| Bandwidth | DC - 2 MHz | DC - 2 MHz | DC - 2 MHz |
| Rise time ¹ | 175 ns or less | 175 ns or less | 175 ns or less |
| DC Accuracy ² | +/- 3% of reading | +/- 3% of reading | +/- 3% of reading |
| Lowest measurable current (at $\pm 3\%$ accuracy at DC) ³ | 1.4 mA | 110 μA | 38 μA |
| Displayed RMS noise, typical (at 20 MHz bandwidth limit) | 200 μA rms or less | 24 μA rms or less | 9.2 μA rms or less |
| Insertion impedance | 0.92 ohm @ 1 MHz 1.88 ohm @ 10 MHz 7.61 ohm @ 50 MHz 14.61 ohm @ 100 MHz | 9.94 ohm @ 1 MHz 10.13 ohm @ 10 MHz 12.61 ohm @ 50 MHz 17.91 ohm @ 100 MHz | 49.53 ohm @ 1 MHz 49.28 ohm @ 10 MHz 49.43 ohm @ 50 MHz 49.91 ohm @ 100 MHz |
| I _{damage} (DC continuous) | 1400 mA | 500 mA | 200 mA |

¹ $T_r = 0.35/(BW \text{ in GHz})$

² Calibrated with a short and remeasured with 50 ohm

³ Calibrated with a short and measured 50 times with short on Iout



DATA SHEET
4T-102

**Typical
Impedance
Plots**

AVCP-1

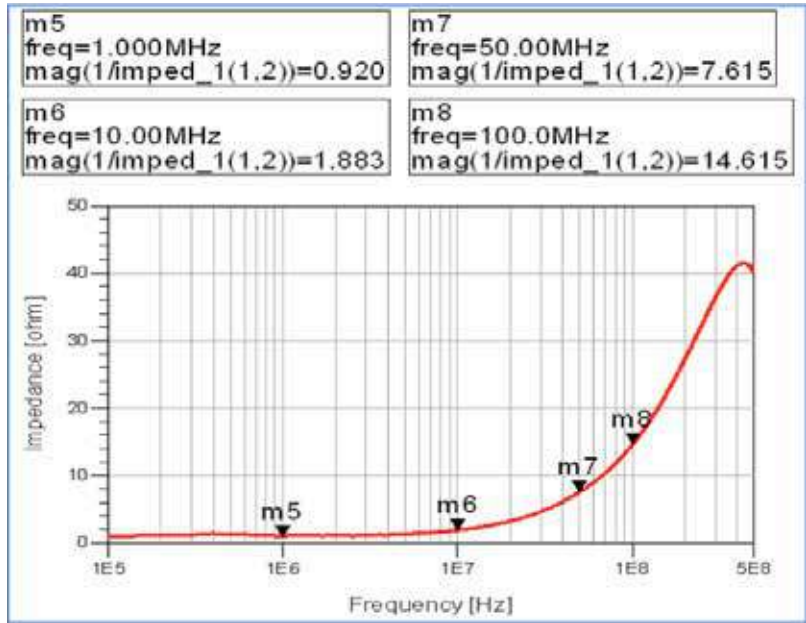

AVCP-10

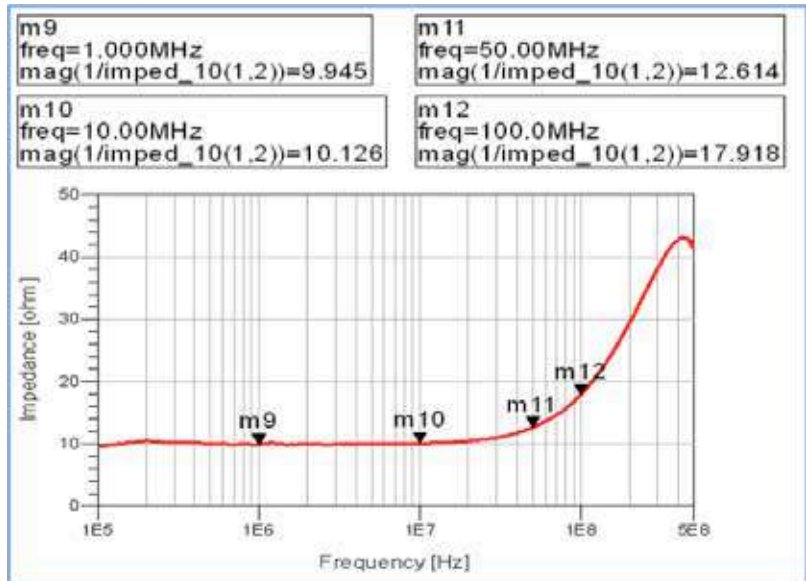

AVCP-50



MT1000 and MT2000 – Mixed-Signal Active Load Pull System (1.0 MHz to 40.0 GHz) And MT2001 System Software



Powered by



U.S. Patent No. 8,456,175 B2

Several international patents also available



Introduction

The MT1000 and MT2000 mixed-signal active load pull systems are the only commercially-proven solutions¹ capable of performing load pull at high speeds of up to 1000 impedance/power states per minute with no limitation on Smith Chart coverage, under the following conditions:

- > Single-tone CW and pulsed-CW RF signal
- > DC and pulsed-DC bias
- > Time-domain NVNA voltage and current waveforms and load lines
- > Fundamental and harmonic impedance control on the source and/or load
- > Frequencies between 1 MHz and 40 GHz²

High-speed load pull with high magnitudes of reflection coefficients under the above conditions are ideal for:

- > Reducing time-to-market due to quicker measurement speed
- > Reducing bottlenecks caused by traditional passive mechanical load pull systems without a loss of accuracy
- > Validating nonlinear compact models
- > Extracting nonlinear behavioral models
- > Research and development, design validation test, and on-wafer production test
- > Improving PA linearity based on controlled baseband terminations
- > Evaluating the performance of a DUT under realistic antenna load conditions
- > Evaluating the performance of DUT under different matching network topologies

In addition, the MT2000 is the only commercially-proven solution¹ capable of wideband impedance control of up to 1000 MHz bandwidth at the fundamental, harmonic and baseband frequencies² and is ideal for

- > Using ACPR and EVM measurement data in the design of wideband PA circuits

The MT1000 and MT2000 are turnkey one-box solutions that replace the functions typically performed by passive fundamental and/or harmonic impedance tuners, VNAs and/or NVNAs, analog signal generators, vector signal generators, vector signal analyzers and oscilloscopes, and add the capabilities of high-speed load pull measurements and wideband impedance control for modulated signals.

¹ as of the publish date of this document

² see Available Models on page 256



DATA SHEET
4T-097

Active Load Pull

In order to understand how the impedance presented to a DUT is varied, we must first consider the DUT as a two-port network shown in Figure 2.

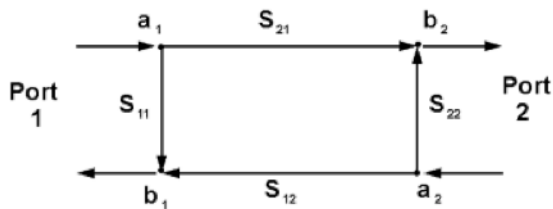

Figure 2. Two-port representation of DUT

The two-port network consists of four waves, a_1 , b_1 , b_2 and a_2 .

- > a_1 is the input signal which is injected into port 1 of the DUT
- > b_1 is the input signal which is reflected from the input of the DUT due to the mismatch between the DUT's input impedance and the load impedance of the input network
- > b_2 is the signal which emerges from port 2 of the DUT
- > a_2 is the output signal which is reflected from the output of the DUT due to the mismatch between the DUT's output impedance and the load impedance of the output network

The magnitude of reflection presented to the DUT is calculated as $\Gamma_L = \frac{a_2}{b_2}$. The magnitude and phase of the reflection presented to the load of the DUT can be varied by changing the magnitude and phase of the signal a_2 . In other words, any load impedance $Z = Z_0 \left(\frac{1+\Gamma_L}{1-\Gamma_L} \right)$ can be presented to the DUT as long as the signal a_2 can be achieved.

With regards to active load pull, the signal a_2 is a vector combination of the reflected portion of b_2 due to the mismatch between the DUT's output impedance and the load impedance of the output network, and a new signal created by a signal generator with magnitude and phase variability (referred to as an active tuning loop). An example block diagram of an active tuning loop is shown in Figure 3.

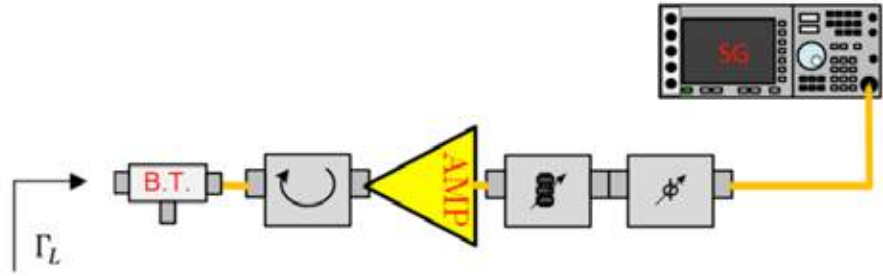

Figure 3. Output network of a simple active load pull setup



In order to perform active load pull, it is necessary to have a vector-receiver capable of accurately measuring the a- and b-waves, as well as signal generator(s) capable of generating output tuning signals.

Mixed-signal active load pull system architecture

A typical mixed-signal active load pull system architecture is shown in Figure 4. Signal analysis of the a₁, b₁, b₂ and a₂ waves is achieved by using mixers and local oscillators to down-convert the RF signal to baseband and processed using wideband analog-to-digital converters (ADCs). Signal synthesis of the input drive signal as well as the active tuning signals is achieved by generating signals at baseband frequencies using wideband arbitrary waveform generators (AWGs) and upconverting to RF using mixers and local oscillators.

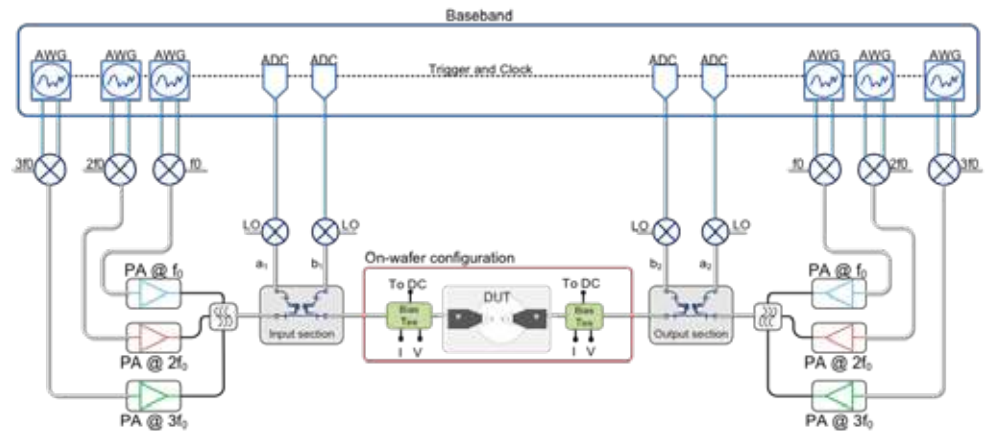

Figure 4 Typical Mixed Signal Active Load Pull System Architecture

A novel calibration and optimization technique correlates the user-desired RF signals at the DUT reference plane with the required baseband signals at the AWG reference plane. This robust technique takes into account the linear and nonlinear characteristics of the internal upconversion/downconversion paths as well as external components including driver amplifiers and bias tees.

Mixed-signal active load pull methodology

First, a wideband signal consisting of hundreds or thousands of frequency components over tens or hundreds of MHz is injected into the input of the DUT. This can be a user-defined signal or a modulated signal compliant to a reference test standard. When driven into nonlinear operating conditions, the resulting b_1 and b_2 waves may have signal distortion as well as baseband and harmonic components.

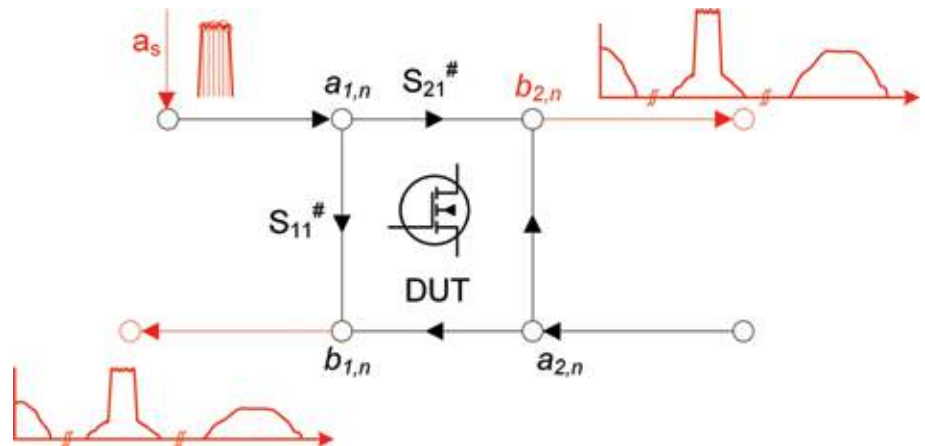

Figure 5 Injected a_s signal and resulting b_1 and b_2 waves



Second, the b_2 wave is measured at the DUT reference plane and the corresponding a_2 is calculated, generated and injected into the output of the DUT such that each frequency component of a_2 has a magnitude and phase that satisfies the user-desired $\Gamma_L = \frac{a_2}{b_2}$. Similarly, a second input signal a_1 can be superimposed on a_s to set the desired source impedances over frequency bandwidth.

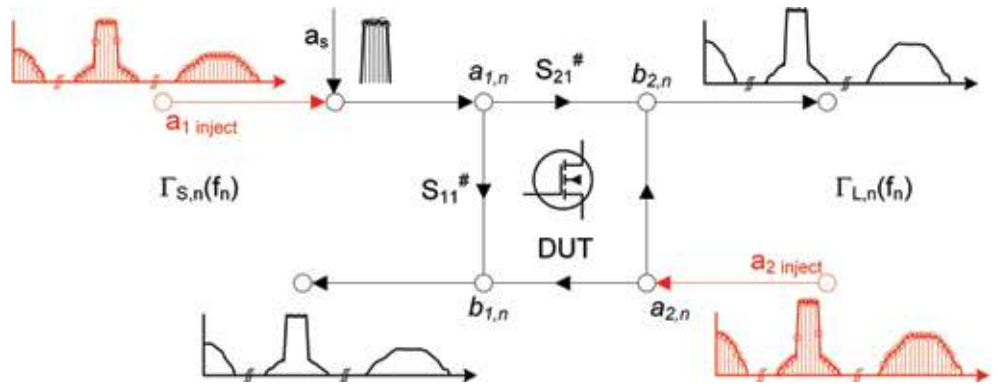

Figure 6 Active tuning a_1 and a_2 signals

Finally, the a- and b-waves are measured at the DUT reference plane, and the tuning signals a_2 and a_1 are modified to converge on the desired reflection coefficients Γ_L and Γ_S .

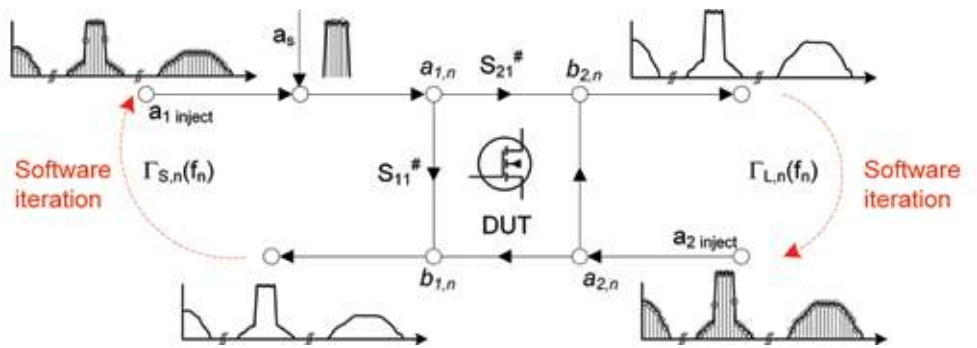

Figure 7 Software iteration of a_1 and a_2 to converge on desired impedances

Due to the use of wideband AWGs and wideband ADCs, it is possible to accurately set user-defined impedances over a bandwidth of hundreds or thousands of MHz (see page 256 for Available Models).

High Speed Single-Tone Active Load Pull Methodology

Wideband modulated signals vary in amplitude and phase over time, such that one repetition of a modulated signal may take 10 ms, as shown in Figure 8 for a LTE-A frame.

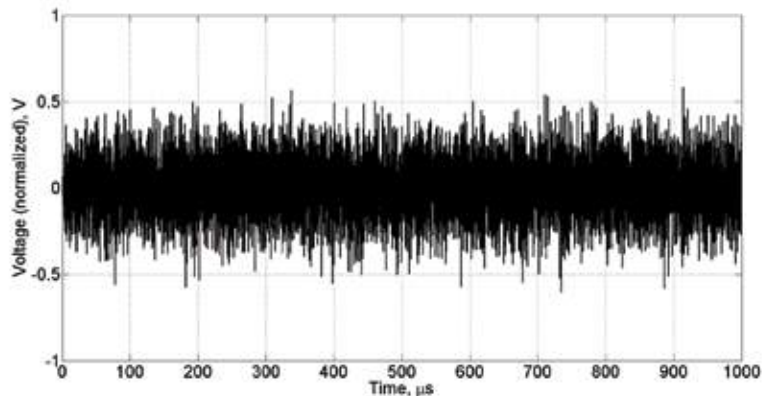

Figure 8 Time-domain representation of an LTE signal



Single-tone signals, on the other hand, can be generated in a much shorter time period, less than 100 us (depending on whether the signal is CW or pulsed-CW, and the pulse width and duty cycle of the pulsed signal). Therefore it is possible to stitch together multiple single-tone a_2 waveforms in order to create a modulated signal, as shown in Figures 9 and 10. The convergence algorithm will treat the stitched modulated waveform in the same manner as a realistic communications modulated signal, but instead of solving $\Gamma_L = \frac{a_2}{b_2}$ for the individual frequency components of a wideband, it will be solved for many sequential single-tone reflection coefficients. In the time it takes to set the reflection coefficient of a single repetition of a wideband modulated signal, tens or hundreds of single-tone signal impedances can be tuned.

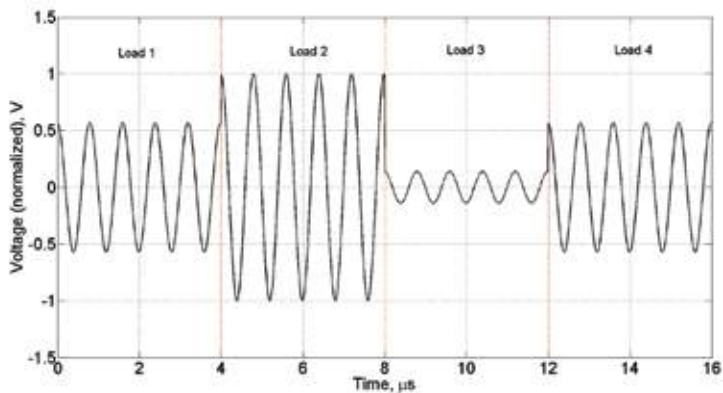

Figure 9 stitched modulated a_2 signal representing multiple single-tone CW reflection coefficients waveforms

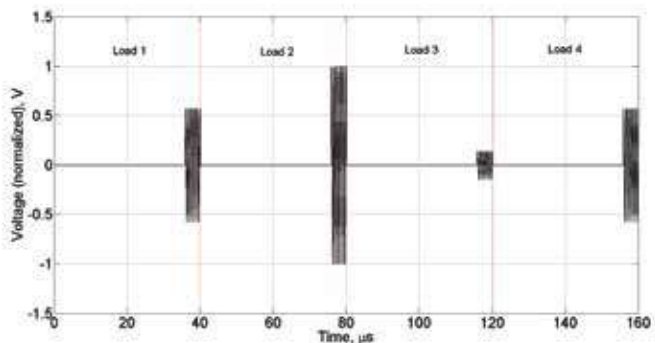

Figure 10 stitched modulated a_2 signal representing multiple single-tone pulsed-CW reflection coefficients waveforms

Available Models / Ordering Information

| Model | System RF Bandwidth (GHz) | Number of Active Tuning Loops | Modulation Bandwidth (MHz) | Power Handling CW/Pulsed CW (W) | Typical Detection Dynamic Range (dB) | Typical Active Load Dynamic Range (dB) | Minimum Pulse Width (ns) |
|---------------|---------------------------|-------------------------------|----------------------------|---------------------------------|--------------------------------------|--|--------------------------|
| MT1000HF2 | 0.03-2.0 | 2 | N/A | 50/500 | 80 | 60 | 2000 |
| MT1000HF4 | | 4 | | | | | |
| MT2000HF2-100 | 0.001-2.0 | 2 | 100 | | | | |
| MT2000HF2-200 | | | 200 | | | | |
| MT2000HF2-500 | | | 500 | | | | |
| MT2000HF4-100 | | 4 | 100 | | | | |
| MT2000HF4-200 | | | 200 | | | | |
| MT2000HF4-500 | | | 500 | | | | |
| MT1000A2 | 0.3-6.0 | 2 | N/A | 100/1000 | 80 | 60 | 2000 |
| MT2000A2-100 | | | 100 | | | | |
| MT2000A2-200 | | | 200 | | | | |
| MT2000A2-500 | | | 500 | | | | |
| MT2000A2-1000 | | | 1000 | | | | |
| MT1000B2 | 0.2-18.0 | 2 | N/A | | | | |
| MT2000B2-100 | | | 100 | | | | |
| MT2000B2-200 | | | 200 | | | | |
| MT2000B2-500 | | | 500 | | | | |
| MT2000B2-1000 | | | 1000 | | | | |
| MT1000B3 | | 3 | N/A | | | | |
| MT2000B3-100 | | | 100 | | | | |
| MT2000B3-200 | | | 200 | | | | |
| MT2000B3-500 | | | 500 | | | | |
| MT2000B3-1000 | | | 1000 | | | | |
| MT1000B4 | 4 | N/A | | | | | |
| MT2000B4-100 | | 100 | | | | | |
| MT2000B4-200 | | 200 | | | | | |
| MT2000B4-500 | | 500 | | | | | |
| MT2000B4-1000 | | 1000 | | | | | |
| MT1000B5 | 5 | N/A | | | | | |
| MT2000B5-100 | | 100 | | | | | |
| MT2000B5-200 | | 200 | | | | | |
| MT2000B5-500 | | 500 | | | | | |
| MT1000B6 | | 6 | N/A | | | | |
| MT2000B6-100 | 100 | | | | | | |
| MT2000B6-200 | 200 | | | | | | |
| MT2000B6-500 | 500 | | | | | | |
| MT1000E2 | 0.7-40.0 | | 2 | N/A | 20/200 | 80 | 60 |
| MT2000E2-100 | | 100 | | | | | |
| MT2000E2-200 | | 200 | | | | | |
| MT2000E2-500 | | 500 | | | | | |
| MT2000E2-1000 | | 1000 | | | | | |
| MT1000E4 | | 4 | N/A | | | | |
| MT2000E4-100 | | | 100 | | | | |
| MT2000E4-200 | | | 200 | | | | |
| MT2000E4-500 | | | 500 | | | | |
| MT2000E4-1000 | | | 1000 | | | | |
| MT1000E6 | 6 | N/A | | | | | |
| MT2000E6-100 | | 100 | | | | | |
| MT2000E6-200 | | 200 | | | | | |
| MT2000E6-500 | | 500 | | | | | |
| | | | | | | | |

MT2001A Power Measurements

MT2001A is the core software of the MT2000 mixed-signal active load pull system and required for each system. It consists of the following capabilities:

- > Fundamental-frequency impedance control at the input and output of the DUT
- > Harmonic-frequency impedance control at the input and/or output of the DUT (requires MT2000 hardware with one active tuning loop for each harmonic frequency for each input/output desired)
- > Standard single-tone CW and pulsed-CW load pull measurements with an average speed of one impedance state at one power in 1s-3s
- > High speed “real-time” single-tone CW and pulsed-CW load pull measurements with an average speed of fifty impedance states at one power in 1s-3s
- > Pulsed-bias load pull (requires pulsed power supply or pulse modulator)
- > Power sweep / gain compression measurements with both standard and high-speed load impedance control
- > Real-time measurement of DUT input and output impedance
- > Advanced sweep plan for custom measurements of impedance, power, frequency, input voltage, output voltage
- > DC and pulsed current and voltage measurements
- > Chronogram / Pulsed configuration with trigger and measurement windows
- > Automated impedance tuner control for optional mechanical pre-match for high power load pull measurements
- > Probe station control (requires semi-automated probe station)
- > CW and pulsed-CW S-parameters measurement
- > Standard measurement parameters include P_{out} , P_{in} , P_{avs} , G_t , G_p , Eff , PAE, V_{in} , V_{out} , I_{in} , I_{out} , AM-AM, AM-PM; custom user-defined parameters

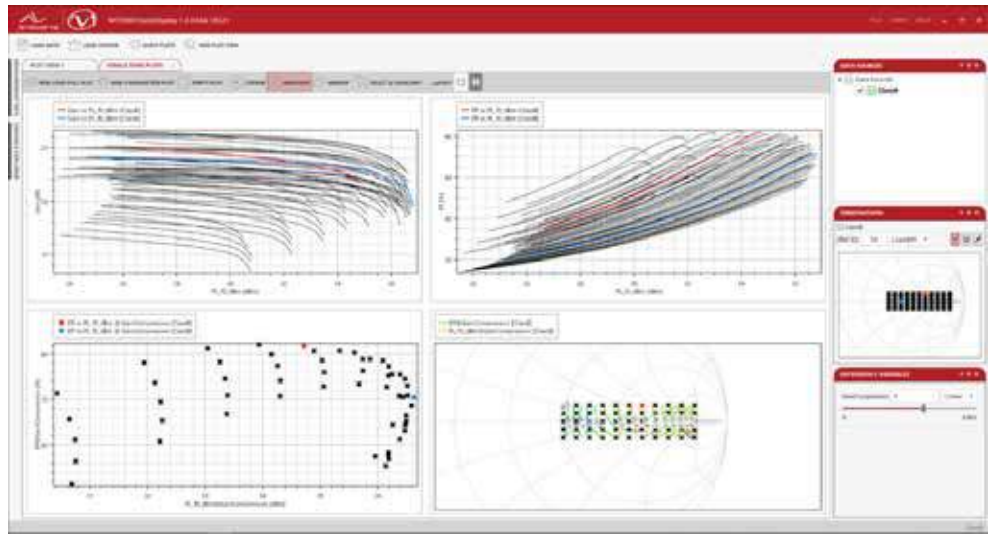

Fundamental-frequency high-speed load pull of 55 impedance states and power sweep at 16 power levels for a total of 880 measurement states in 3 minutes.

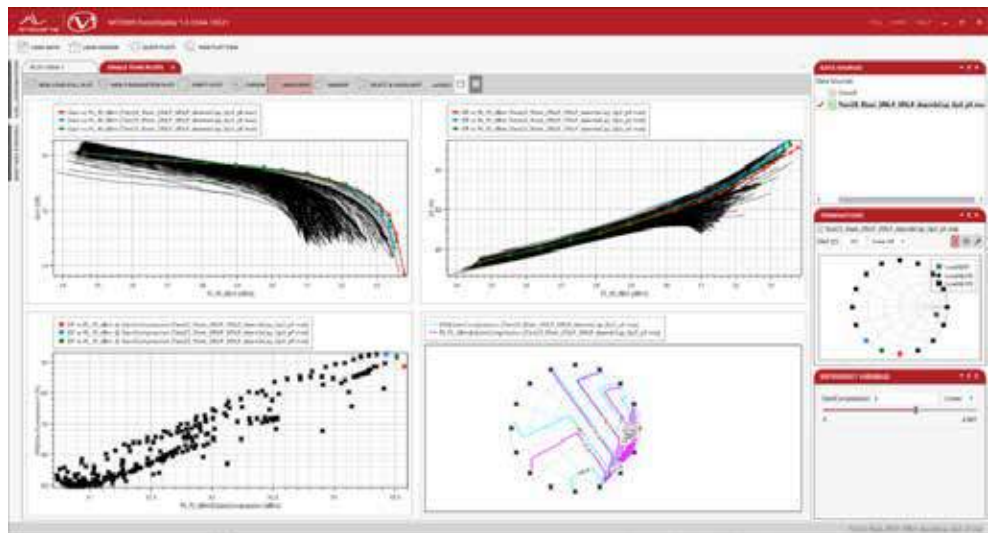

Harmonic-frequency high-speed load pull of 1 Fo impedance state, 16 2Fo impedance states, 16 3Fo impedance states and power sweep at 17 power levels for a total of 4352 measurement states in 15 minutes.

MT2001B Modulated Load Pull Measurements

MT2001B is an add-on option to MT2001A which enables wideband impedance control for modulated signals over the modulation bandwidth of the hardware (see Available Models / Ordering Information). In addition to the capabilities of MT2001A, MT2001B adds the following:

- > Library of standard commercially available modulated signals
- > Utility to define custom modulated signals
- > Automatic signal pre-distortion to create a clean modulated signal at the DUT reference plane
- > Wideband impedance control as follows
 - > Ability to set all impedance over the modulated bandwidth at a single impedance point (i.e. all frequency components of an 80 MHz 5G signal should be tuned to 5Ω)
 - > Ability to set user-defined phase delay of impedance vs frequency over the modulated bandwidth (i.e. a 0.1 degree/MHz phase delay resulting in an overall phase shift of 8 degrees on the Smith Chart for an 80 MHz 5G signal)
 - > Ability to load S1P file (user-created, from circuit simulator...) defining impedance vs frequency over the modulated bandwidth. Ideal for evaluating realistic matching network designs (i.e. stub vs transmission line) and evaluating DUT performance under realistic antenna load response
- > Vector signal analysis of modulated signals
- > Adaptive averaging enhances measurement speed without sacrificing accuracy
- > Import and export I and Q baseband waveforms for offline digital pre-distortion load pull (DPD)
- > Standard measurement parameters include ACPR, EVM, spectral mask; custom parameters

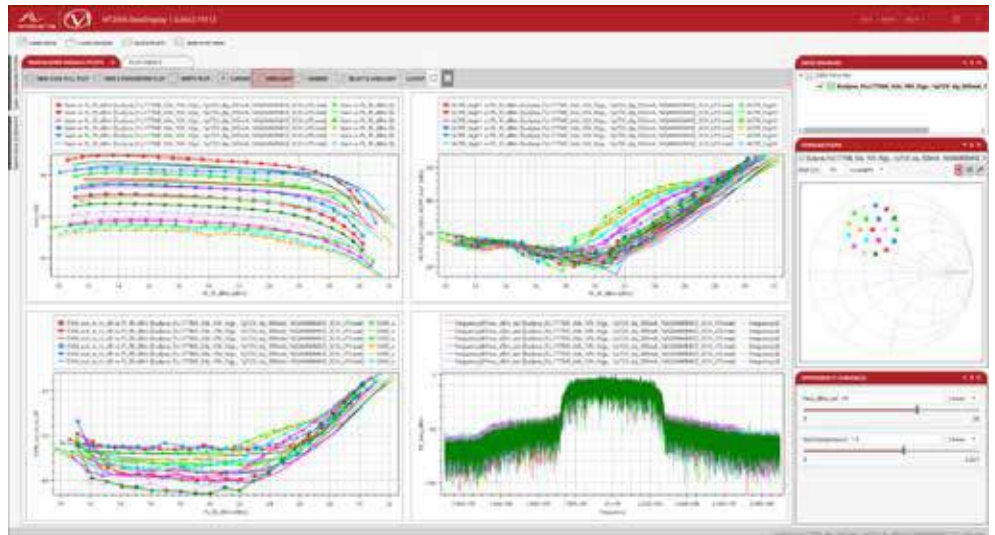

Fundamental-frequency modulated load pull of 20 impedance states and power sweep at 26 power levels, where all impedances over the modulated bandwidth of 200 MHz are set to a single impedance state.

MT2001C Two Tone Load Pull Measurements

MT2001C is an add-on option to MT2001A which enables impedance control for two-tone signals with tone spacing within the modulation bandwidth of the hardware (see Available Models / Ordering Information). In addition to the capabilities of MT2001A, MT2001C adds the following:

- > Set tone spacing to user-defined values
- > Sweep tone-spacing during load pull measurement
- > Automatic signal pre-distortion to create a balanced two-tone signal at the DUT reference plane
- > Adaptive averaging enhances measurement speed without sacrificing accuracy
- > Standard measurement parameters include IMDx, OIPx; custom parameters



Fundamental-frequency two-tone load pull of 7 impedance states and power sweep at 26 power levels, with a tone spacing of 80 MHz.

MT2001D NVNA and Time-Domain Analysis

MT2001D is an add-on option to MT2001A which enables Nonlinear VNA (NVNA) time-domain analysis of voltage and current waveforms and load lines for single-tone CW and pulsed-CW signals. In addition to the capabilities of MT2001A, MT2001D adds the following:

- > Automatically measure current and voltage waveforms and load lines
- > Standard measurement parameters include $V_1(t)$, $V_2(t)$, $I_1(t)$, $I_2(t)$; custom parameters

It is important to note that the addition of NVNA time-domain measurements does not increase the overall measurement time and is compatible with both standard and high-speed load pull methodologies.

The MT1000/MT2000 hardware includes a tone-generator which acts as a harmonic phase reference (HPR). A single external harmonic phase reference or comb generator is required for system calibration.

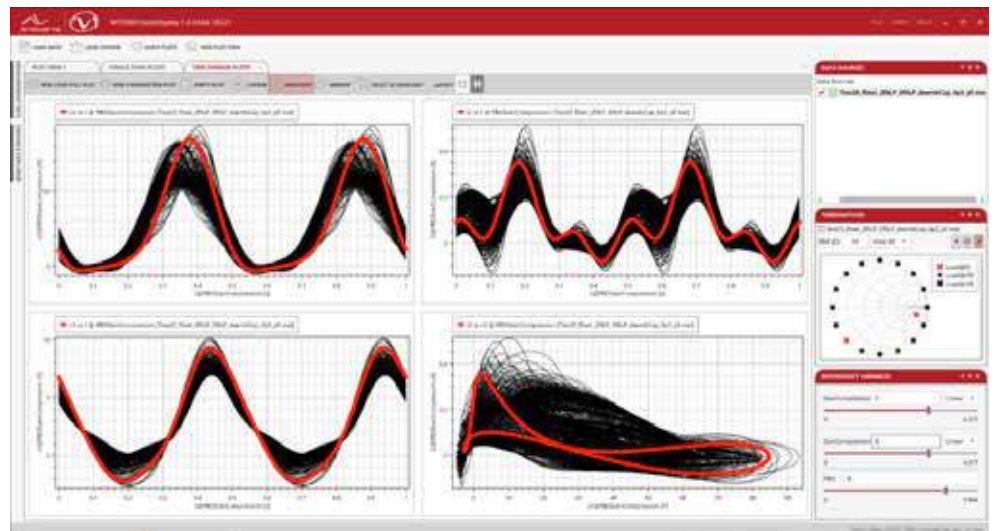

Harmonic-frequency high-speed load pull of 1 F_0 impedance state, 16 $2F_0$ impedance states, 16 $3F_0$ impedance states and power sweep at 17 power levels for a total of 4352 measurement states in 15 minutes, with the addition of NVNA time-domain voltage and current waveforms and load lines.

MT2001E External Control

MT2001E is an add-on option to MT2001A which enables external control of the MT2001A software through an API. MT2001E supports the following measurements:

- > Single-tone CW measurements
- > Single-tone pulsed-CW measurements
- > S-parameters measurements

The MT2000 API library has the following functions and are fully documented in the MT2000 API user manual:

- | | |
|-------------------------------------|---------------------------------------|
| > MT2000Initialize | > MT2000SaveResults |
| > MT2000Terminate | > MT2000GetVariableData |
| > MT2000SingleToneLoadPull_Pulsed | > MT2000GetTermsIndexes |
| > MT2000SingleToneLoadPull_CW | > MT2000GetTermsRectangularSweep |
| > MT2000SetTerminationsSweep | > MT2000GetTermsPhaseSweep |
| > MT2000SetBiasSettings | > MT2000SetConvergenceOptions |
| > MT2000SetBiasSearch | > MT2000SetDCMeasureFromSupply |
| > MT2000SetPowerSweep | > MT2000MeasureSParameters |
| > MT2000SetLinPowerSweep | > MT2000SetSParametersAvg |
| > MT2000SetPowerSweepLimitCondition | > MT2000SetSParametersIFBW |
| > MT2000SetDeembedding | > MT2000SetSParametersPower |
| > MT2000SetMeasurementWindows | > MT2000SetSParametersSingleFrequency |
| > MT2000SetupTriggerExport | > MT2000SetSParametersFrequencySweep |
| > MT2000SetupPulsedDC | > MT2000GetSParametersData |

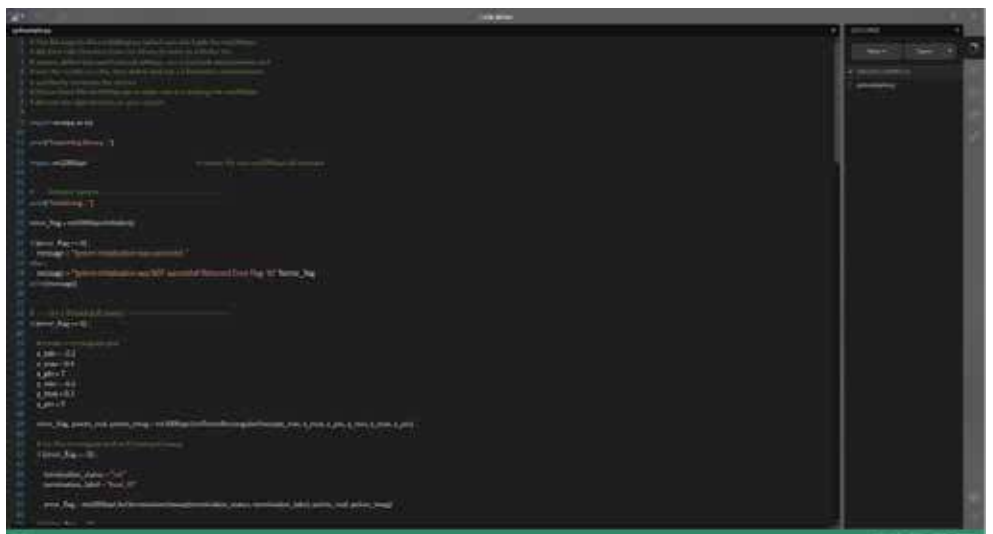
A screenshot of a Python script in a code editor. The script is dark-themed and contains several lines of code, including comments and function calls. The code appears to be a sequence of API calls for the MT2000 library, such as initialization, setting parameters, and performing measurements. The script is titled 'mt2000.py' and is located in a directory named 'C:\Users\james\Documents\mt2000\'. The code includes comments in both English and Chinese, and uses various API functions like 'MT2000Initialize', 'MT2000SetPowerSweep', and 'MT2000MeasureSParameters'.

Python example of a script calling MT2000 API

MT2001F Visualization and Analysis

MT2001F is standalone software option which enables the visualization and analysis of measurement data taken from MT2001A, MT2001B, MT2001C, MT2001D and MT2001G modules. MT2001F has the following capabilities:

S-Parameters

- > Plot S-parameters in standard and custom formats including log magnitude, linear magnitude, phase, polar, Smith Chart
- > Overlay multiple S-parameters data sets

Load Pull

- > Plot load pull contours on the Smith Chart
- > Plot load pull parameters on XY graphs
- > Plot power sweep / gain compression curves on XY graphs
- > Plot time-domain load pull contours and graphs
- > Plot contours and graphs based on dependency parameters (i.e. PAE vs Pout at a fixed gain compression)
- > Interconnected plots allow inputs on one plot to be executed on all plots (i.e. selecting an impedance on one plot will show the corresponding measurement results for that impedance on all plots)
- > Overlay multiple load pull measurement data sets

Export

- > Export measurement data in MAT, SPL, CSV, MDF and XLS formats
- > Export plots in JPG and PNG graphic formats

Templates

- > Save/recall customized visualization plots/graphs, associated parameters and markers
- > Save/recall layout for multiple plots/graphs on a single report

MT2001G Baseband Impedance Control

MT2001G is an add-on option to MT2001B and MT2001C which enables baseband impedance control, which may improve linearity resulting in better IMx and ACPR performance. In addition to the capabilities of MT2001B and MT2001C, MT2001G adds the following:

- > Controls impedances at baseband frequencies caused by mixing product of two-tone or modulated signals
- > Source and load baseband impedance control

In addition to the MT2000 hardware, external baseband drive amplifiers are required and are selected based on user-required voltages and currents (i.e. ADA4870 baseband amplifier to meet requirements of $V=40V$, $I=1A$, $BW=80\text{ MHz}$).

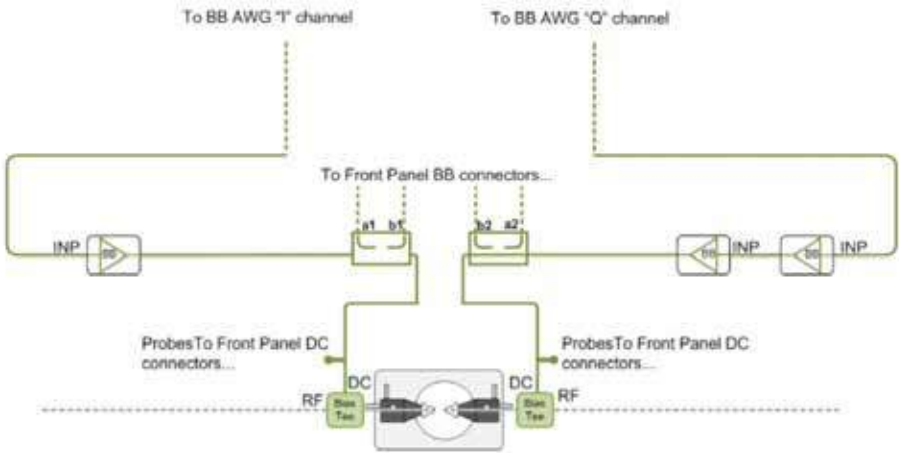

Block diagram of baseband impedance control hardware configuration

Pulsed IV Systems

AM3200 SERIE 3



Systems category: Standard

- > Compact and efficient design
- > Embedded power supplies
- > Flexible and upgradable
- > Unrivalled measurement resolution and accuracy
- > High reliability pulse generators
- > Driven by IVCAD Software

Main Features

- > Reliable pulsers with long lasting performances (thermal, SOA and DUT breakdown protections)
- > Pulsed or DC operation, pulse width down to 200ns from the generators
- > Internal or external synchronization
- > Extended stop conditions and built-in protection
- > Mix-and-match input and output pulsers
- > Connect systems in series for synchronizing 3+ pulsed channels
- > Long pulses into the tens of seconds for trapping and thermal characterization
- > Direct hardware programmability

System Description

This Pulse IV system is used to bias transistors in quasi-isothermal conditions, it enables accurate compact modeling activities.

Pulsers Safe Operating Area

Emergency stop when the operating point exceeds design limits: I_p , I_{rms} , I_{dc} (pulsed, RMS and DC current), V_{dc} (pulser input voltage, drain pulser only), P_{max} (DC power), F_{max} (switching frequency), Temperature.

Current Breaker

Programmable thresholds: pulse current and power, quiescent current and power, transient current.

Measurement Sampling Time

Fully programmable, 20ns resolution, External synchronization Mtrig & Rfpulse.

Modularity

The standard system works with two pulse generators and one control box. External signals permit to combine and synchronize several control boxes (4, 6, 8...).

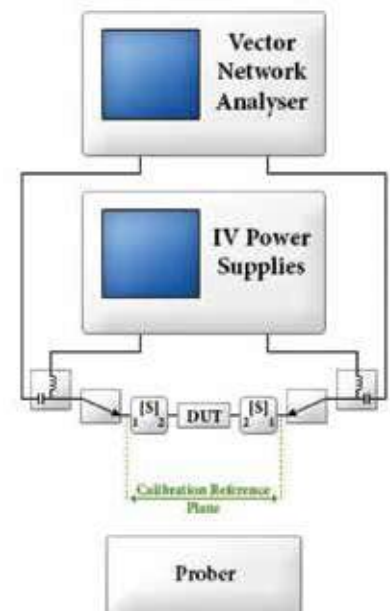

AM3211 Bipolar Probe +/-25V +/-1A

The AM3211 is a low noise floating pulse generator dedicated to bias the transistor gate, optimized to drive quickly and safely all the transistors (RF Devices, MOSFET).

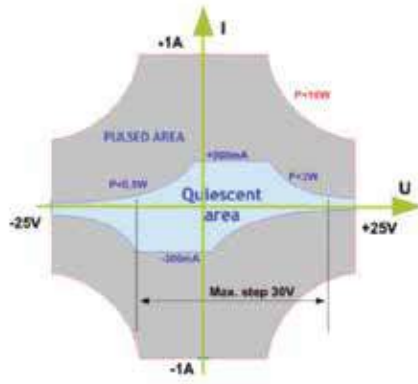

AM3221 Probe +250V +30A

The AM3221 probe is a power probe dedicated to bias the transistor drain, optimized for high power pulsed measurements.

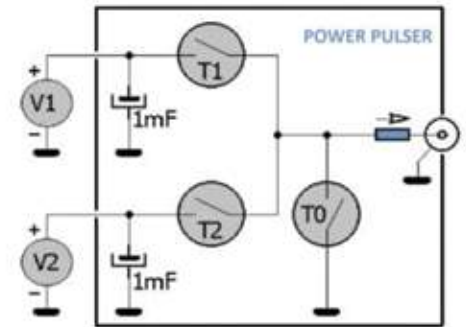

Control Box AM3200 System

| | | |
|---------|--------|--------|
| Pulsers | AM3211 | AM3221 |
| Purpose | Gate | Drain |

Operating Range

| | | |
|-------------------------|-----------|-------|
| Switched voltage levels | 2 | 2 |
| Voltage | $\pm 25V$ | +250V |
| Pulsed current | $\pm 1A$ | +30A |
| DC & RMS Current | 300mA | 5A |
| DC power | 3W | 100W |

Source Performance

| | | |
|----------------------------|---|--|
| Voltage setting resolution | 16bit | 18bit |
| Output impedance | $I \leq 0.1mA$: 204 Ω / $I > 0.1mA$: 14.5 Ω | $I \leq 0.3A$: 2 Ω / $I > 0.3A$: 0.4 Ω |

Pulse Timing

| | | |
|-----------------------|---|---------------------------------------|
| Rise Time (10% - 90%) | Fast: 33ns ¹ (typ. Value) | Fast: 20ns ² (typ. Value) |
| Fall Time (10% - 90%) | Fast: 32ns ¹ (typ. Value) | Fast: 22ns ² (typ. Value) |
| Pulse timing | Resolution: 20ns, Width: 200ns to DC (Power limits) | |
| Fmax | 500kHz | |

Measurement Performance

| | | |
|---|------------------------------------|-------------------------|
| V range | 25V | 250V/5V |
| I range | 1A/10mA/0.1mA | 30A/3A/0.3A |
| V & I ADC resolution | 16bit | 16bit |
| Noise free resolution (average filter 128 samples, at 0 voltage and current) | 0,5mV | 3mV/0,25mV |
| | 30 μA /3 μA /0,3 μA | 0,3mA/0,13mA/10 μA |
| Settling time | 300ns | 300ns |
| Bandwidth (greatest range) | 10MHz | 10MHz |
| Output connector | D-SUB15 | 2 BNC |

¹ AM3211, speed: fast, no load, 5V step

² AM3221, speed: fast, no load, 100V step

Ultimate Measurement Speed and Performances

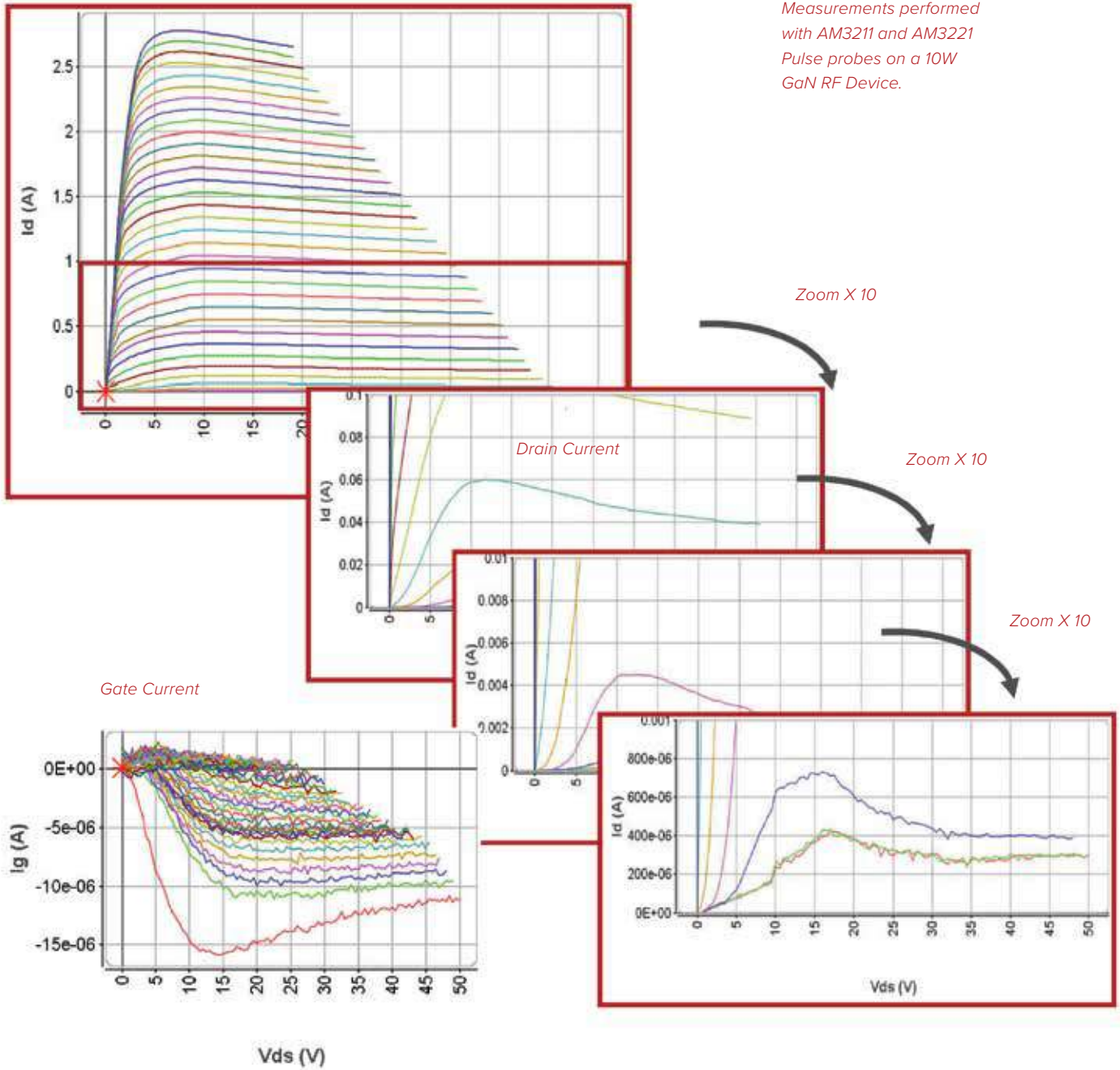

System Specifications

Warranty

Any AMCAD product comes with a two-year parts and labour warranty, when returned to our workshops. A phone support service is also available for the same period.

At the end of the initial two-year period, a further contract can be subscribed, including:

- > a preventive functional check and calibration of the modules (on site or in our workshop)
- > a further two-year warranty period

Quality Regulations & Environment

The PIV System and all modules are compliant to the applicable European directive and hold the CE mark.

- > ISO/CEI 17025 compliant calibration for any DC source or measurement module, calibration certificate provided.
- > Serial number based life cycle management
- > All products are 100% tested (test reports on demand)
- > AMCAD only uses RoHS compliant components and does not use substances banned by the COSHH regulation.
- > AMCAD complies with the relevant national regulations related to the safety and health of its employees against hazardous substances.
- > The protection degree of the PIV system is IP20 according to CEI 60529.

Probe dimensions (mm)

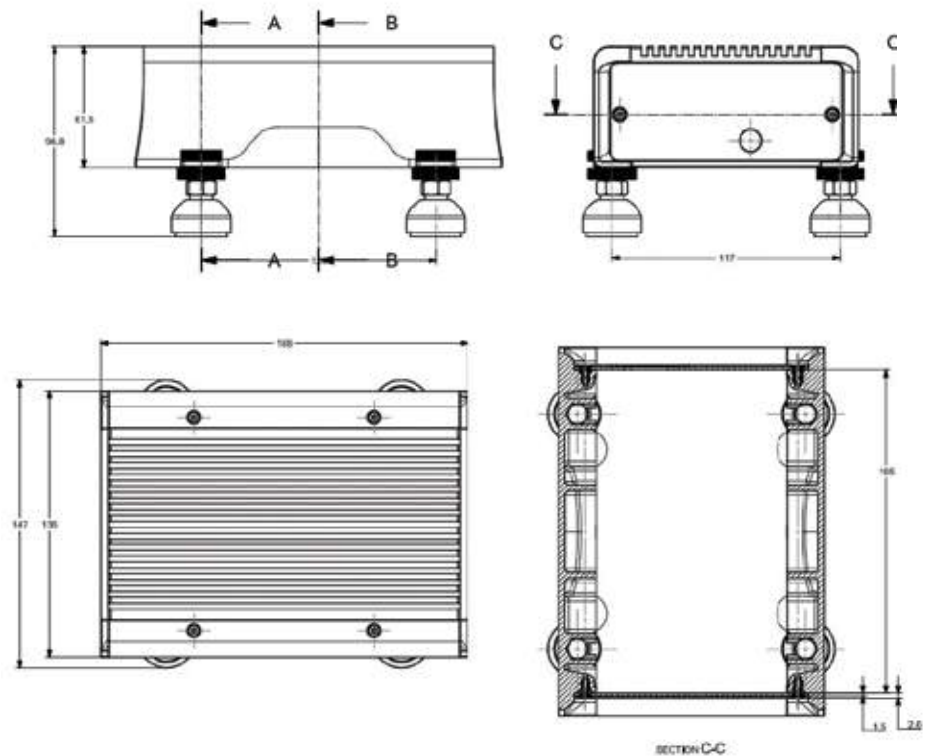

Pulsed IV Systems

AM3100 SERIE 3



Systems category: Standard

- > Compact and efficient design
- > Embedded power supplies
- > Cost effective pulsed DC supply and measurement solution
- > Synchronization capabilities for multiple instrument measurements
- > Driven by IVCAD and IQSTAR Software



AM3100 used for pulsed bias of Power Amplifiers

Main Features

- > Reliable pulse units with long lasting performances (thermal, SOA and DUT breakdown protections)
- > Pulse or DC operation with pulse width down to 1us from the generator and for measurements
- > Internal and external synchronization
- > Extended stop conditions and built-in protection
- > Direct hardware programmability (SCPI commands)
- > Embedded measurement units providing wide bandwidth and high accuracy for simultaneous current and voltage measurements
- > Embedded fast short-circuit current breaker, performing the protection of the external pulse unit as well as external components such as Bias Tees
- > Remote control through LAN or USB
- > Compatible with IVCAD and IQSTAR Software's

System Description

The AM3100 is a standalone Pulsed IV system for Pulse Load Pull and general-purpose test pulsed applications. AM3100 PIV systems are used to bias transistors or circuits in pulsed conditions to avoid self-heating and ensure quasi-isothermal conditions during the measurements.



Pulsed DC and RF Load Pull bench architecture

Power amplifiers are often driven by pulsed RF signal combined with continuous or pulsed DC bias conditions. This brings some complexity to the bench configuration. Indeed, even when continuous DC voltages supplies are used, the pulsed RF signal magnitude will drive the transistor consumption in pulsed mode also, if the PA operates in saturated area.

In order to measure the peak current to evaluate the peak efficiency, there is a need for synchronized pulsed IV and pulsed RF measurements.

In term of measurement speed and system integration, the AM3100 PIV system will replace advantageously complex measurement architectures made of DC multimeters or external oscilloscope combined with external DC supplies.



AM3111 Pulse SMU +/-25V +/-0.2A

Embedded inside the AM3103 Main controller, the Gate Pulse SMU presents the following characteristics:

- > 4-quadrant DC or Pulse voltage source.
- > Down to 1 μ s pulse width, 20ns time resolution.
- > Simultaneous voltage and current sampling.
- > Pulse and Quiescent level sampling time points can be chosen automatically by the source or manually by the user.
- > 1 voltage range: $\pm 25V$
- > 2 current ranges: $\pm 5mA$ and $\pm 200mA$
- > No transient when powering on/off or switching on/off
- > Output on isolated BNC connector
- > Operating range: DC: Gray area, Pulse: Gray + Lilas areas

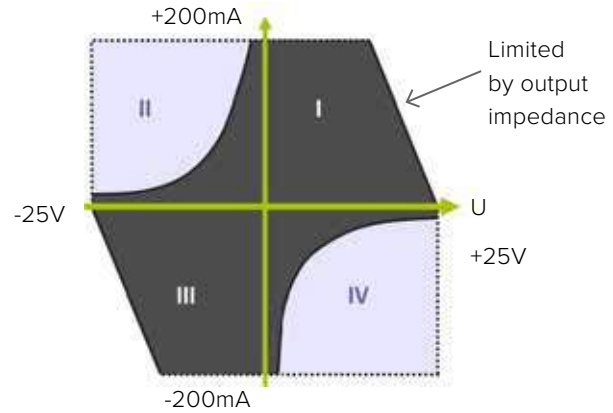
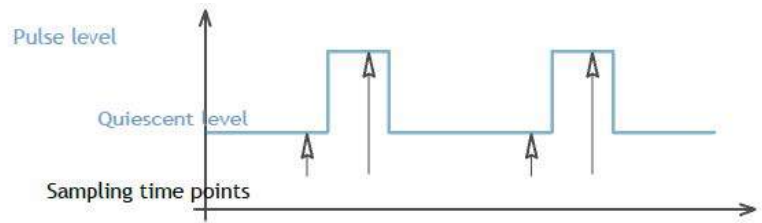

| Parameters | Conditions/Comments | Min | Max |
|---------------------------|---|-------------|--------|
| Voltage programming range | | -25V | 25V |
| Output current | Guaranteed: source stops if +/-260mA is exceeded | -200mA | 200mA |
| Output power | Source, DC | | 3W |
| | Sink, DC | | 0.5W |
| Pulse | Width | 1.1 μ s | 10s |
| | Frequency | 0.1Hz | 200KHz |
| | Duty cycle | 0% | 100% |
| Temperature | Ambient temperature in front of the chassis rear openings | 10°C | 30°C |

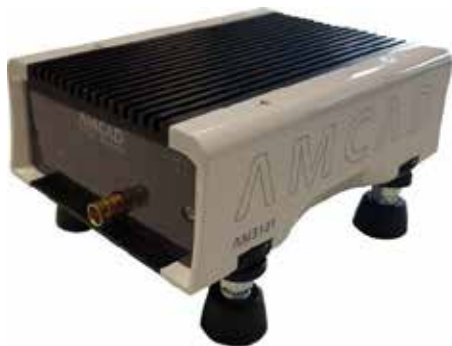

AM3121 Pulse SMU +120V +30A

The AM3121 Pulse SMU is a power probe dedicated to bias the transistor drain (Positive voltages). Optimized for high power pulsed measurements applications (120V, 30A), this probe head embed a current breaker and can be used either for Load Pull applications or general-purpose pulsed SMU.

The Strig signal performs overall synchronization of start, stop, and emergency stop.

Using either constant level or pulsed mode, the Ptrig signal performs overall synchronization of the power pulse, the measurement sampling time and the transient mask.

- > Isolated DC voltage source
- > Fast toggling current and power limitation
- > 2-quadrant, source & sink operating area
- > 18-bit voltage programming, no missing code
- > Safe charging and discharging of any load capacitor
- > Programmable voltage slope
- > No transient when powering on/off

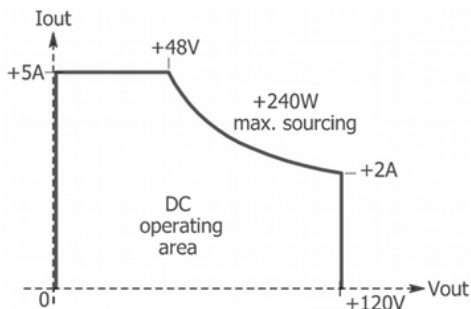

| Parameters | Conditions | Value |
|-----------------|------------------------------|------------|
| Input voltage | | 120V |
| Pulsed current | | 30A |
| Average current | | 5A |
| RMS current | | 10A |
| Pulsed current | | 3000W |
| DC power | | 220W |
| Earth isolation | Between power gnd. and earth | 220kΩ 120V |

System Schematic and measurements specifications

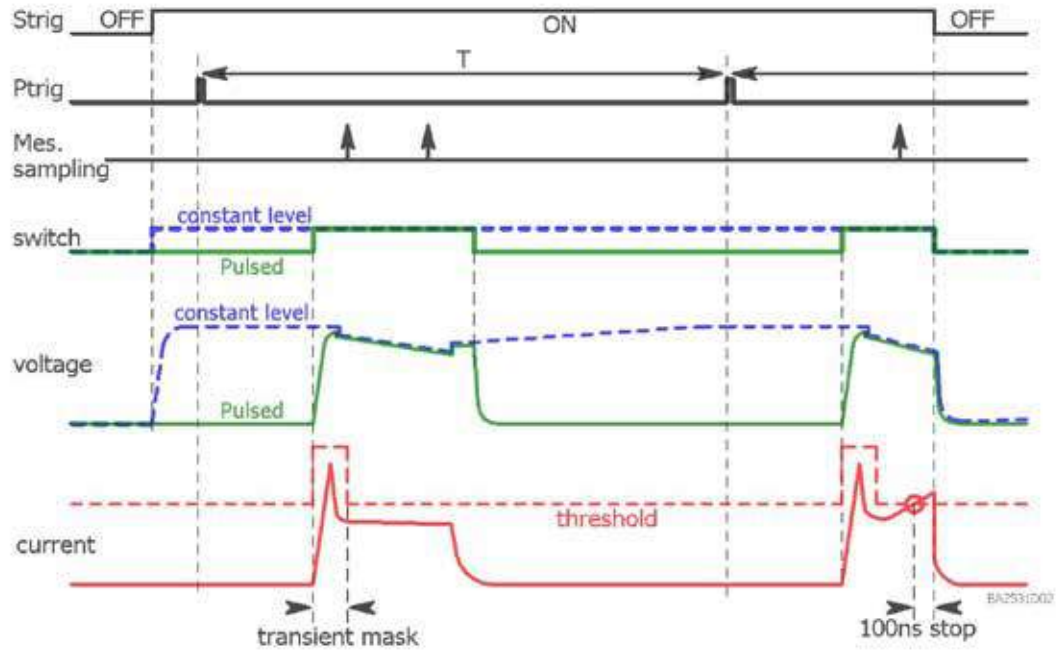
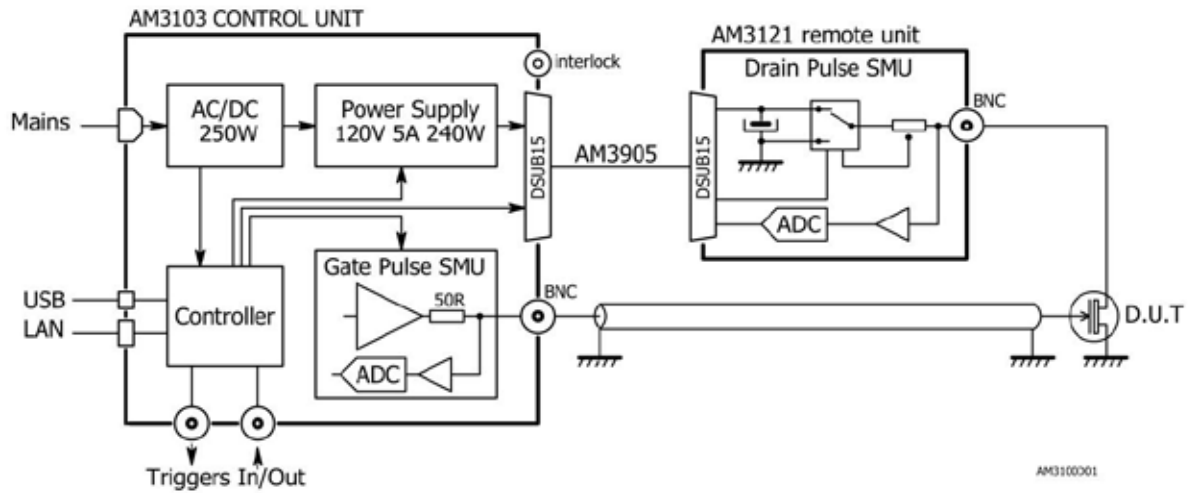

AM3111 Measurement specifications

| Parameters | Conditions/Comments | 25V Range | 200mA Range | 5mA |
|-------------------|-----------------------------|--------------|--------------|-------------|
| ADC resolution | 15-bit | 0.9mV | 7µs | 170nA |
| Noise | | +/-2mV | +/-30µs | +/-5µs |
| Setting time | To 95% To ADC resolution | 0.5µs 2µs | 0.5µs 2µs | 1µs 4µs |
| Absolute accuracy | Offset + % reading, 2-year | 7.5mV + 0.1% | 100µs + 0.2% | 10µs + 0.2% |

AM3121 Measurement specifications

| Parameters | Conditions/Comments | Voltage | Current |
|-------------------|-----------------------------|--------------|--------------|
| Measurement range | | 125V | 33A |
| ADC resolution | 16 bits | 2.1mV | 550µs |
| Setting time | To 95% To ADC resolution | 0.5µs 2µs | 0.5µs 2µs |
| Noise | | +/-15mV | +/-2mA |
| Absolute accuracy | Offset + gain | 20mV + 0.1% | 20mA + 0.3% |

AM3100 Pulse Timing definition

| Parameters | Conditions/Comments | Spec | Min | Max |
|----------------------------------|--|---------|---------------|--------------|
| Time jitter | Ptrig to any output | | | +/-2.5ns |
| Minimum time delay from ptrig | Fixed delay ptrig to any output | 200ns | 190ns | 210ns |
| Time delay calibration error | Parameter inside each pulse | +/-10ns | | |
| Time resolution | Delay and duration counting | 20ns | | |
| Pulses duration setting range | | | 1µs | 10s |
| Pulses delay setting range | | | 1µs | 10s |
| Sample clock delay setting range | | | -1µs | 10s |
| Internal ptrig range | Period (timer resolution 1µs) Frequency | | 5µs 200KHz | 10s 0.1Hz |

Warranty

Any AMCAD product comes with a two-year parts and labour warranty, when returned to our workshops. A phone support service is also available for the same period. At the end of the initial two-year period, a further contract can be subscribed, including:

- > • a preventive functional check and calibration of the modules (on site or in our workshop)
- > • a further two-year warranty period

Quality Regulations & Environment

The PIV System and all modules are compliant to the applicable European directive and hold the CE mark.

- > ISO/CEI 17025 compliant calibration for any DC source or measurement module, calibration certificate provided.
- > Serial number based life cycle management

- > All products are 100% tested (test reports on demand)
- > AMCAD only uses RoHS compliant components and does not use substances banned by the COSHH regulation.
- > AMCAD complies with the relevant national regulations related to the safety and health of its employees against hazardous substances.
- > The protection degree of the PIV system is IP20 according to CEI 60529.

RF Device Characterization System Integration

FULLY INTEGRATED COAXIAL AND MILLIMETER-WAVE DEVICE CHARACTERIZATION SYSTEMS, 250 MHz TO 110 GHz

Features

- > Power and noise parameter measurements
- > Packaged and On-Wafer measurements
- > Modulated, pulsed and CW signals
- > Automated in-situ calibration
- > Fewer connections
- > Reliable and fast RF switching
- > Saves time and money
- > Turnkey systems available – Works “out of the box”

Description

Maury's mission is to meet its customers' device characterization needs regardless of the level of complexity. Maury has and continues to provide solutions covering the entire measurement spectrum; from the simplest stand-alone tuner to fully integrated turnkey systems.

Integrated systems are offered between 250 MHz and 110 GHz, in-fixture and on-wafer, and are capable of measuring the following:

- > S-Parameters
- > X-Parameters
- > DC-IV and Pulsed-IV measurements
- > Power Measurements: Pout, Pin-delivered, Gain, Compression, Efficiency, Harmonic Powers...
- > Multi-Tone Measurements: IMD, TOI...
- > Modulated Measurements: ACPR, EVM, CCDF...
- > Noise Parameters: NFmin, Γ_{opt} , R_n , Noise and Gain contours
- > Time-domain Analysis: a-b waves, I-V waves, load lines...
- > Thermal Microscopic load pull

Maury will integrate these features into an easily assembled and calibrated system that is straightforward to use, saving time as well as money. Furthermore, the results will display greater accuracy and repeatability. Less time and less money means a more profitable design cycle.

In-situ Calibration

The power of a Maury integrated system begins with its proprietary in-situ calibration method, which allows for a complete system-level calibration without disconnecting any of the core system components. The majority of calibration and measurement errors occur for the following reasons; multiple VNA calibrations with improper reference-plane shifting, probes that are connected/disconnected multiple times or measured on their own, and multiple small measurement errors that cascade into very large errors. Unlike the above situations, in-situ calibration requires only one single connection, makes use of highly-repeatable and reliable RF switches and automates the calibration procedure through the use of a graphic wizard. Overall system level verification procedures built into the ATS software result in average deltaGT values of less

than 0.2 dB at all magnitudes and phases, when performing an in-situ calibration.

Turnkey Measurement Systems

Maury works very closely with instrument and component manufacturers to offer complete turnkey noise parameters as well as large-signal test systems for both on-wafer and packaged device measurements. Recognized as the global leader in microwave and millimeter-wave tuners and DC systems, Maury has partnered with numerous multinational companies who are also leaders in their respective fields. Examples include Keysight Technologies for RF Instruments (Network Analyzers, Spectrum Analyzers, Power meters, Power supplies), Cascade Microtech (on-wafer probe stations, probes and positioners), Intercontinental Microwave (test fixtures and jigs), Quantum Focus Instruments (Thermal IR cameras), Auriga Measurement Systems (Pulsed IV), as well as component and cabling manufacturers. Turnkey measurement systems are available for sign-off and acceptance at Maury's corporate office.



MT900N Series Fully Integrated 2.4mm 50 GHz LSNA Measurement System.



DATA SHEET
5A-039

MT900-series integrated on-wafer millimeter-wave s-parameters, noise parameters and load pull system, including swept two-tone measurements.



MT900-series integrated on-wafer millimeter-wave s-parameters, noise parameters and load pull measurement system.



Measurement and Modeling Device Characterization Services



Why Measurement Services?

Maury's team of experienced application engineers operates its state-of-the-art characterization laboratories to provide time-sensitive measurement services each and every day. Maury customers have taken advantage of our expertise and resources to meet their objectives on time and on budget. Some of the reasons our customers work with us include: completing short term or infrequent projects, eliminating bottlenecks and accelerating delivery by working in parallel, validating in-house measurements, establishing proof of concept and system justification, always using state-of-the-art tools, reducing capital expenditures and improving the balance sheet.

We are better suited to meet our customers' needs due to the flexibility associated with measurement and modeling device characterization services.

Scenario 1: Short-term or project-specific need

Tom has been mandated to design an application-specific amplifier which will be integrated into his company's next-generation transceiver. Since Tom's projects each have unique requirements, Tom has not been able to acquire his own load pull system, let alone the periphery instruments required to integrate the solution or the experience required to

operate the system efficiently. Tom takes advantage of Maury's experience and resources by executing a measurement service and is able to complete his project without the investment in capital equipment.

Scenario 2: System proof-of-concept and justification

John believes a noise parameter measurement system would improve his overall low-noise amplifier development time by validating his models, and allowing him to make refinements on an ongoing basis. Before making the investment in capital equipment, John contracts a measurement service and receives a complete set of measurement results as a deliverable. With data in hand, John proves he is able to improve his LNA design flow and feels secure in acquiring his own system.

Scenario 3: Eliminating bottleneck and accelerating delivery

Lisa is responsible for technology selection at her company and is in the process of evaluating multiple device topologies. With Lisa's deadline to report her findings approaching quickly, Lisa knows she will not be able to complete her evaluation within the allotted time period. Lisa outsources a portion of her measurements in order to increase her effective measurement capacity and is therefore able to complete all measurements, and compile her report with recommendations, in time.





Lab Equipment*

- > Network analyzers: Keysight N5242A, N5245A, N5247B
- > Signal sources: Keysight N5181A, N5183A, E4438C
- > Signal analyzers: Keysight N9010A, N5242A/N5245A/N5247B, NI 5644R, Maury Microwave MT2000E4-1000
- > Noise analyzers: Keysight N8975A, N5242A/N5245A/N5247B with option 029
- > Power meters: Keysight N1911A, E4416A, E4417A, E4418B, E4419B, U2002A, U8488A, and power sensors
- > IV analyzers: AMCAD Engineering AM3200 pulsed IV system
- > Oscilloscopes: Keysight DSO7104A, DSO1024A and probes
- > Probe stations: Cascade Summit 9000 manual, Summit 11K manual, Summit 12K semi-automatic, and MPI TS3000
- > Impedance tuners: multiple Maury Microwave MT981BL01, MT982BL01, MT984AL01, MT985AL01, and MT2000E4-1000
- > Miscellaneous: DC and RF accessories

** Equipment list accurate at date of print*

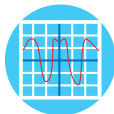

DATA SHEET
1H-003

| Services Offered | Measurement Parameters | Measurement Capability |
|---|--|--|
|  <p>DC and Pulsed IV Measurements</p> | Fixed and swept voltages and currents for I_d , I_g , V_d , V_g and computation of g_m | On-wafer and in-fixture DC and Pulsed IV characterization up to 1000V and 30A |
|  <p>CW and Pulsed S-Parameter</p> | Two-port S-parameter (S_{11} , S_{12} , S_{21} , S_{22}) characterization at user-defined reference plane | On-wafer and in-fixture CW and pulsed-CW S-parameter measurements between 10 MHz and 67 GHz |
|  <p>Noise Figure/ Parameters Measurements</p> | Noise figure: NF50 Noise parameters: NF50, NFmin, Γ_{opt} , R_n , noise circles (typical noise measurements performed in screen room / Faraday cage) | On-wafer and in-fixture measurements Noise figure – 10 MHz to 50 GHz Noise parameters – 400 MHz to 67 GHz |
|  <p>Power Measurements- CW/ Pulsed-CW Signal</p> | Power parameters including available and delivered input power (P_{in}), delivered output power (P_{out}) at individual frequencies, transducer and power gain, power-added and drain efficiency, intermodulation distortion products (IMD, if applicable) | On-wafer and in-fixture power measurements between 10 MHz and 67 GHz CW and pulsed-CW, single-tone and two-tone RF signal DC and pulsed bias conditions Fixed and swept impedance at fundamental and harmonic frequencies |
|  <p>Power Measurements- Modulated Signal</p> | In addition to power parameters above, modulated parameters including adjacent channel power/leakage (ACLR/ACPR) and error vector magnitude (EVM) | On-wafer and in-fixture power measurements between 400 MHz and 40 GHz using commercial and user-defined modulated signal |
|  <p>Power Measurements- Nonlinear VNA (NVNA)</p> | In addition to power parameters above, nonlinear time-domain current and voltage waveforms and RF load lines | On-wafer and in-fixture power measurements between 400 MHz and 40 GHz |

Please contact us to explore how Maury can support your measurement and modeling needs.

Sample Measurements

Visualization of output power vs PAE at fixed 3dB gain compression

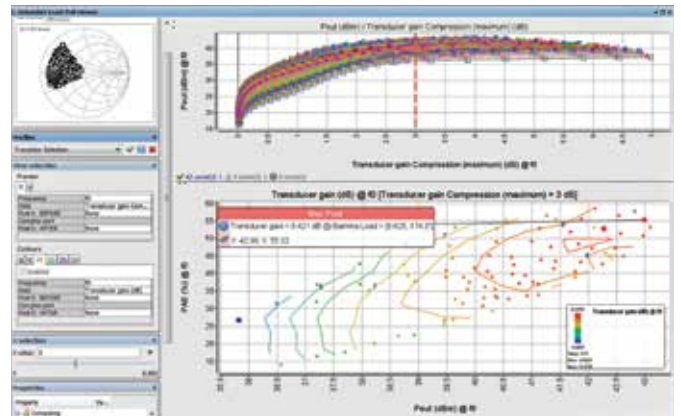

Power sweep at multiple impedances

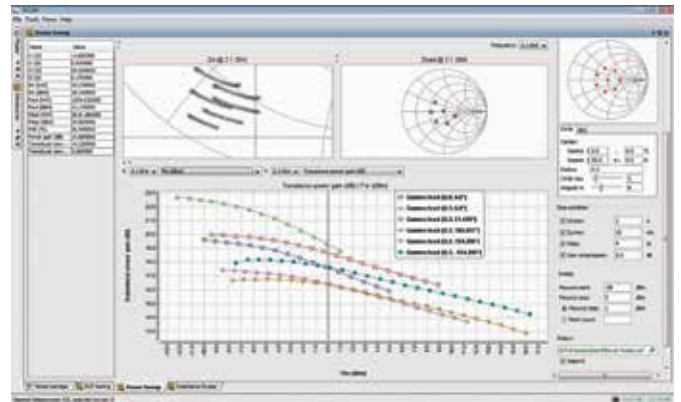

Impedance sweep at fixed power

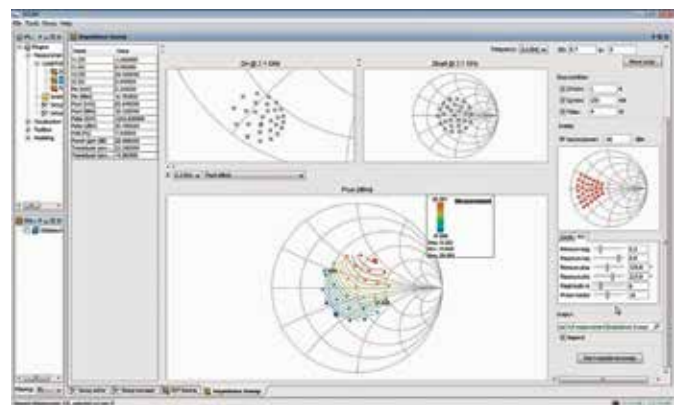

Output current waveforms at constant input power under varying load impedances

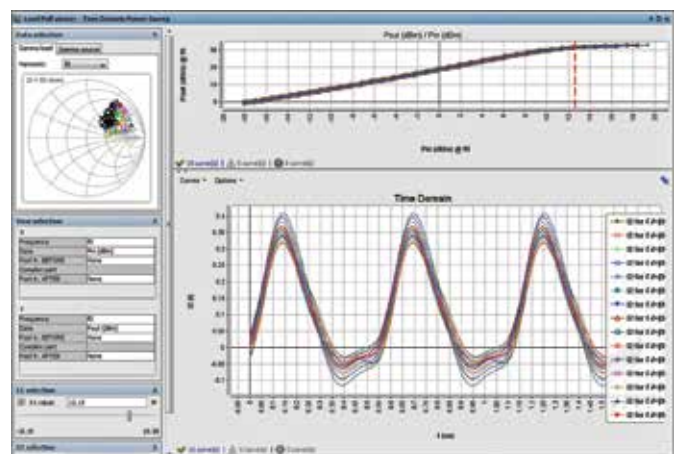

Sample Measurements Continued

DC and RF load lines at constant input power under varying load impedances

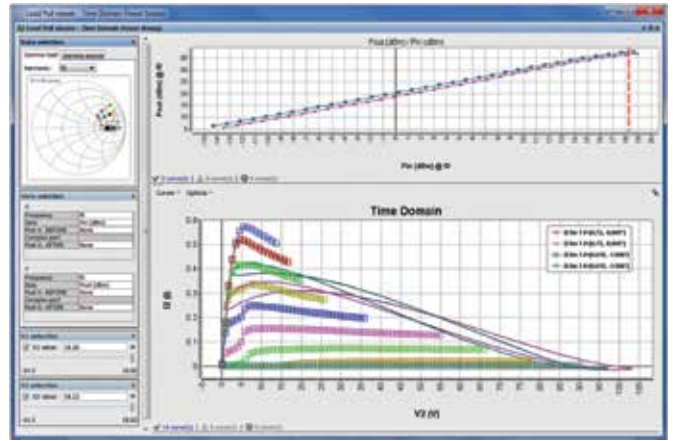

IV curves at various wafer positions

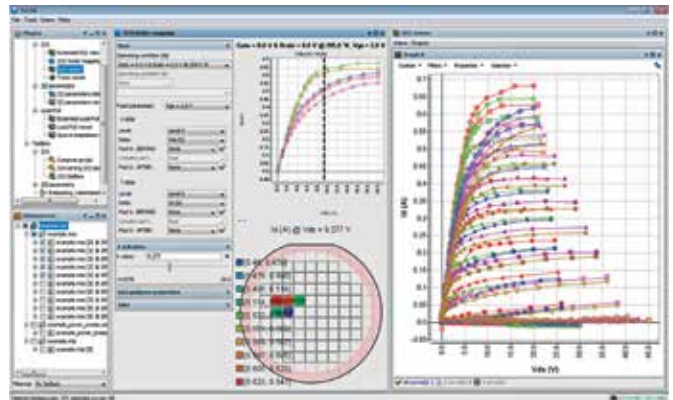

Broadband swept noise parameters

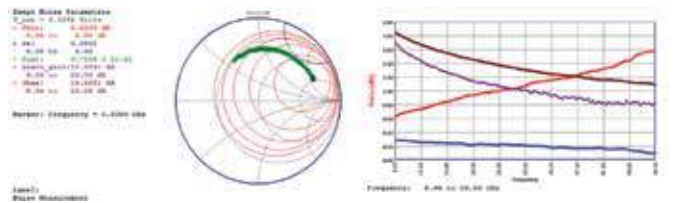

Active load pull of multi-channel LTE signal

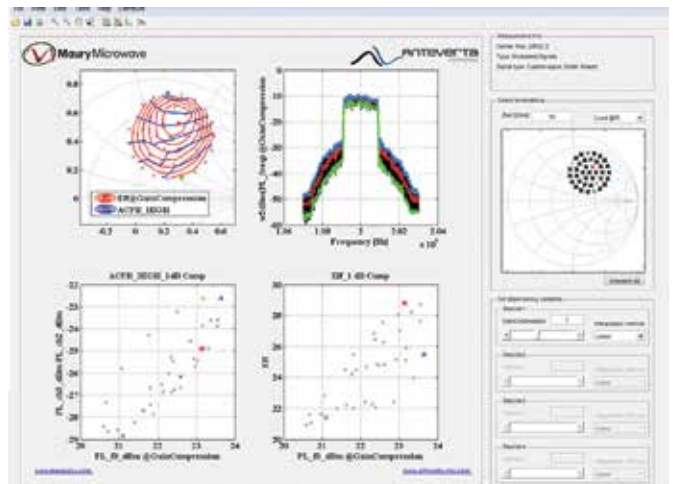

Measurement and Modeling
Device Characterization Facilities

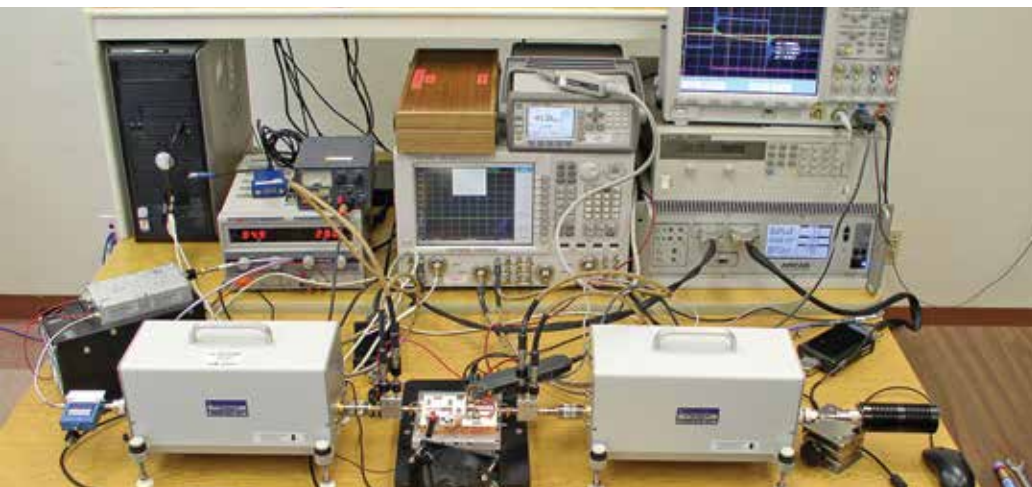

Where You Can Find Us

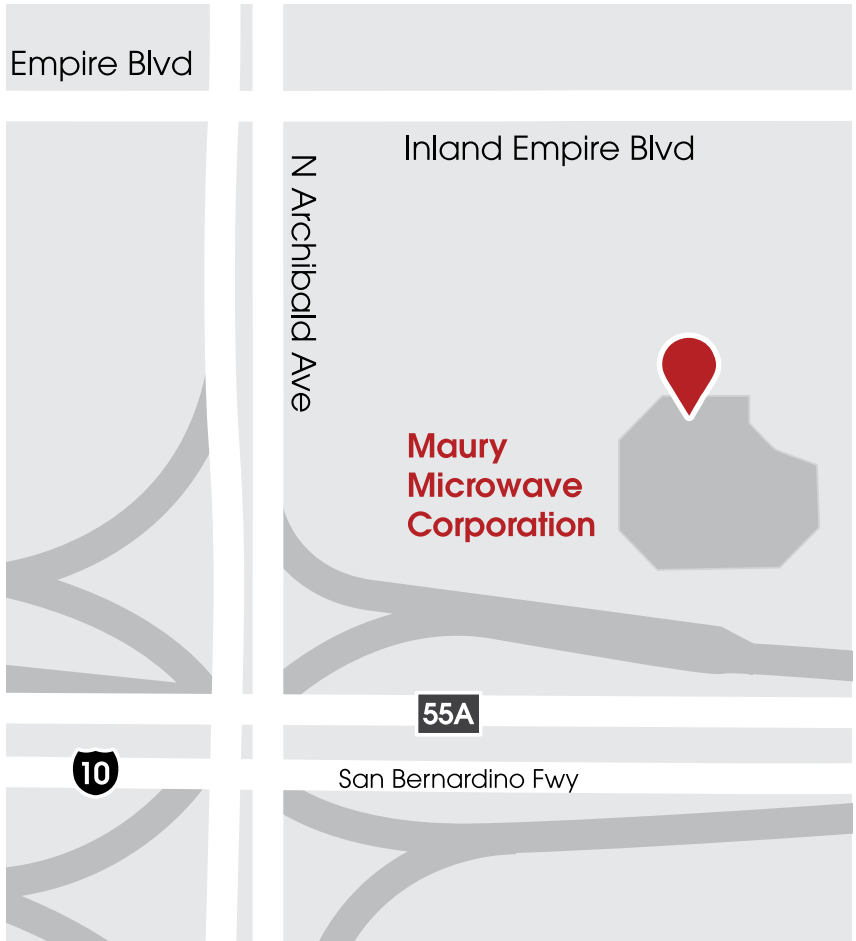
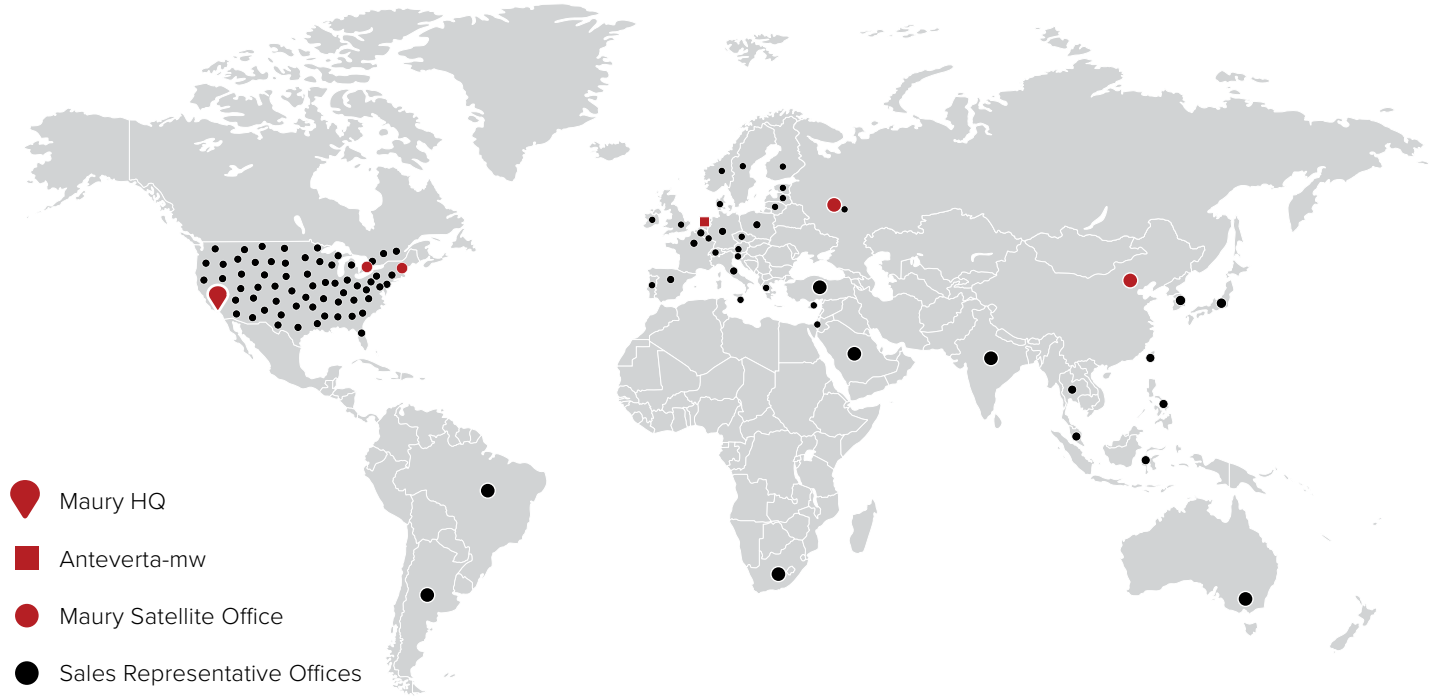

Address

📍 2900 Inland Empire Blvd
 Ontario, CA 91764 USA

Social Media

in [Linkedin.com/company/maury-microwave](https://www.linkedin.com/company/maury-microwave)
🐦 [Twitter.com/MauryMicrowave](https://twitter.com/MauryMicrowave)
You Tube [Youtube.com/MauryMicrowave](https://www.youtube.com/MauryMicrowave)

Contact Us

✉ sales@maurymw.com
☎ 909 987 4715
🌐 www.maurymw.com

2900 Inland Empire Blvd.
Ontario, California 91764-4004
Tel: 909 987 4715 / Fax: 909 987 1112
Email: maury@maurymw.com
Web Site: maurymw.com

Catalog 1G-010 (2022.1/A)
© 2022 Maury Microwave Corporation.
All Rights Reserved.

Maury Microwave

